



XD series PLC expansion module

User Manual

WUXI XINJE ELECTRIC CO., LTD.

Data No. PD04 201603022 3.1

This manual includes some basic precautions which you should follow to keep you safe and protect the products. These precautions are underlined with warning triangles in the manual. About other manuals that we do not mention please follow basic electric operating rules.

Precautions



Please follow the precautions. If not, it may lead the control system incorrect or abnormal, even cause fortune lose.

Correct Application



The models could only be used according to the manual, and an only be used along with the peripheral equipment recognized or recommended by X Company. They could only work normally in the condition of be transported, kept and installed correctly, also please operate and maintain them according to the recommendation.

WUXI XINJE ELECTRIC CO., LTD. Copyright reserved
Without exact paper file allowance, copy, translate or using the manual is not allowed. Disobey this, people should take the responsibility of loss. We reserve all the right of expansions and their design patent.

Duty Declare

We have checked the manual; its content fits the hardware and software of the products. As mistakes are unavoidable, we couldn't promise all correct. However, we would check the data in the manual frequently, and in the next edition, we will correct the necessary information. Your recommendation would be highly appreciated.

Catalog

1. MODULES INTRODUCTION	8
1-1. MODULE TYPE AND CONFIGURATION	8
1-1-1. Module type and names	8
1-1-2. Module configuration	2
1-1-3. Terminal resistor XD-ETR	2
1-2. DIMENSIONS	3
1-3. MODULE PART NAME AND FUNCTION	4
1-4. GENERAL SPECIFICATIONS	5
1-5. MODULE POWER AND SERVICE CONDITIONS	5
1-6. MODULE INSTALLATION	7
1-7. CONFIGURE THE MODULE	9
2. I/O EXPANSION MODULE XD-ENXMY	10
2-1. SPECIFICATIONS	10
2-2. TERMINALS	11
2-3. I/O ADDRESS ASSIGNMENT	12
2-4. EXTERNAL CONNECTION	22
2-5. MODULE PARAMETERS	24
2-6. APPLICATIONS	29
3. ANALOG INPUT/OUTPUT MODULE XD-E4AD2DA	33
3-1. SPECIFICATION	33
3-2. TERMINALS	34
3-3. THE ASSIGNMENT OF I/O ADDRESS	35
3-4. WORKING MODE	40
3-5. EXTERIOR CONNECTION	43
3-6. AD CONVERSION DIAGRAM	45
3-7. PROGRAMMING	47
4. ANALOG INPUT MODULE XD-E4AD	48
4-1. SPECIFICATIONS	48
4-2. TERMINALS	49
4-3. I/O ADDRESS ASSIGNMENT	50
4-4. WORKING MODE	54
4-5. EXTERIOR CONNECTION	56
4-6. AD CONVERSION DIAGRAM	57
4-7. PROGRAMMING	58
5. ANALOG INPUT MODULE XD-E8AD	59
5-1. SPECIFICATION	59
5-2. TERMINALS	60
5-3. I/O DISTRIBUTION	60
5-4. WORKING MODE	66
5-5. EXTERIOR CONNECTION	69

5-6. AD CONVERSION DIAGRAM	70
5-7. PROGRAM APPLICATION	71
6. ANALOG INPUT MODULE XD-E8AD-A	72
6-1. SPECIFICATION	72
6-2. TERMINALS	73
6-3. I/O DISTRIBUTION	73
6-4. WORKING MODE	79
6-5. EXTERIOR CONNECTION	82
6-6. AD CONVERSION DIAGRAM	83
6-7. PROGRAM APPLICATION	84
7. ANALOG INPUT MODULE XD-E8AD-V	85
7-1. SPECIFICATION	85
7-2. TERMINALS	86
7-3. I/O DISTRIBUTION	86
7-4. WORKING MODE	92
7-5. EXTERIOR CONNECTION	95
7-6. AD CONVERSION DIAGRAM	96
7-7. PROGRAM APPLICATION	97
8. ANALOG OUTPUT MODULE XD-E2DA	98
8-1. SPECIFICATIONS	98
8-2. TERMINALS	99
8-3. I/O ADDRESS ASSIGNMENT	99
8-4. WORKING MODE	102
8-5. EXTERNAL CONNECTION	104
8-6. DA CONVERSION DIAGRAM	105
8-7. PROGRAMMING	105
9. ANALOG OUTPUT MODULE XD-E4DA	106
9-1. SPECIFICATIONS	106
9-2. TERMINALS	107
9-3. I/O ADDRESS ASSIGNMENT	107
9-4. WORKING MODE	111
9-5. EXTERNAL CONNECTION	113
9-6. DA CONVERSION DIAGRAM	114
9-7. PROGRAMMING	115
10. N CHANNELS PRESSURE MODULE XD-ENWT-A	116
10-1. FEATURES	116
10-2. TERMINALS	117
10-3. EXTERNAL CONNECTION	119
10-4. WEIGHING SYSTEM	120
10-5. MODULE FUNCTIONS	121
10-5-1. Pressure sensor	121

10-6. I/O ADDRESS	121
10-7. WORKING MODE	124
10-8. MODULE SETTING	126
10-9. INSTRUCTION FROM AND TO	127
10-10. A/D TRANSFORMATION DIAGRAM	131
10-11. APPLICATION PROGRAM	132
11. 2 CHANNELS PRESSURE MODULE XD-E2WT-B	133
11-1. FEATURES	133
11-2. TERMINALS	134
11-3. EXTERNAL CONNECTION	135
11-4. WEIGHING SYSTEM	136
11-5. MODULE FUNCTIONS	137
11-5-1. Pressure sensor	137
11-6. I/O ADDRESS	137
11-7. WORKING MODE	139
11-8. MODULE SETTING	140
11-9. INSTRUCTION FROM AND TO	142
11-10. A/D TRANSFORMATION DIAGRAM	145
11-11. APPLICATION PROGRAM	146
12. N CHANNELS PRESSURE MODULE XD-ENWT-C	147
12-1. FEATURES	147
12-2. TERMINALS	148
12-3. EXTERNAL CONNECTION	150
12-4. WEIGHING SYSTEM	151
12-5. MODULE FUNCTIONS	152
12-5-1. Pressure sensor	152
12-6. I/O ADDRESS	153
12-7. WORKING MODE	156
12-8. MODULE SETTING	158
12-9. MODULE ERROR INFO	160
12-10. INSTRUCTION FROM AND TO	161
12-11. AD TRANSFORMATION DIAGRAM	164
12-12. APPLICATION PROGRAM	164
13. N CHANNELS PRESSURE MODULE XD-ENWT-D	166
13-1. FEATURES	166
13-2. TERMINALS	167
13-3. EXTERNAL CONNECTION	169
13-4. WEIGHING SYSTEM	171
13-5. MODULE FUNCTIONS	171
13-5-1. Pressure sensor	171
13-6. I/O ADDRESS	172
13-7. WORKING MODE	176

13-8. MODULE SETTING	178
13-9. MODULE ERROR INFO	180
13-10. INSTRUCTION FROM AND TO	181
13-11. APPLICATION PROGRAM	184
14. PT100 TEMPERATURE CONTROL MODULE XD-E6PT-P	185
14-1. SPECIFICATION	185
14-2. TERMINALS	186
14-3. I/O ADDRESS ASSIGNMENT	187
14-4. WORKING MODE	188
14-5. FROM/TO INSTRUCTION	190
14-6. EXTERIOR CONNECTION	195
14-7. PROGRAMMING	196
15. PT100 TEMPERATURE CONTROL MODULE XD-E4PT3-P	199
15-1. SPECIFICATION	199
15-2. TERMINALS	200
15-3. I/O ADDRESS ASSIGNMENT	200
15-4. WORKING MODE	201
15-5. FROM/TO INSTRUCTION	203
15-6. EXTERIOR CONNECTION	208
15-7. PROGRAMMING	209
16. THERMOCOUPLE TEMPERATURE CONTROL MODULE XD-E6TC-P(-H), XD-E2TC-P	212
16-1. SPECIFICATION	212
16-2. TERMINALS	214
16-3. EXAMPLE OF INPUT/OUTPUT WIRING	215
16-4. I/O ADDRESS ASSIGNMENT	216
16-5. WORKING MODE	217
16-6. FROM/TO INSTRUCTION	220
16-7. EXTERIOR CONNECTION	225
16-8. PROGRAMMING	227
17. SSI ENCODER DETECTION MODULE XD-E4SSI	230
17-1. SPECIFICATION	230
17-2. TERMINAL EXPLANATION	231
17-3. THE ASSIGNMENT OF I/O ADDRESS	232
17-4. WORKING MODE	235
17-5. EXTERNAL CONNECTION	237
17-6. PROGRAM EXAMPLE	237
18. ANALOG EXTENSION MODULE XD-E2AD2PT2DA	238
18-1. SPECIFICATION	238
18-2. TERMINALS	239
18-3. THE ASSIGNMENT OF I/O ADDRESS	240
18-4. WORKING MODE	244

18-5. EXTERIOR CONNECTION	247
18-6. AD CONVERSION DIAGRAM	249
18-7. PROGRAMMING	250
19. ANALOG EXTENSION MODULE XD-E3AD4PT2DA	251
19-1. SPECIFICATION	251
19-2. TERMINALS	252
19-3. THE ASSIGNMENT OF I/O ADDRESS	253
19-4. WORKING MODE	258
19-5. EXTERIOR CONNECTION	261
19-6. AD CONVERSION DIAGRAM	262
19-7. PROGRAMMING	263
20. X-NET RELAY MODULE JR-EH	265
20-1. SUITABLE CONDITION	265
20-2. FEATURES	265
20-3. APPEARANCE	265
20-4. BAUD RATE	266
20-5. LED	266
20-6. WIRING DIAGRAM	266
20-7. MODULE NAMING RULE	267
20-8. DIMENSION	267
21. ANALOG INPUT MODULE XD-E12AD-V	268
21-1. SPECIFICATION	268
21-2. TERMINALS	269
21-3. I/O DISTRIBUTION	270
21-4. WORKING MODE	276
21-5. EXTERIOR CONNECTION	279
21-6. AD CONVERSION DIAGRAM	279
21-7. PROGRAM APPLICATION	280

1. Modules introduction

1-1. Module type and configuration

XD series PLCs not only have strong functions of logic operation, data operation, high speed processing etc. but also A/D, D/A conversion, PID function. With the expansions of analog input module, analog output module, temperature control module etc. XD series PLCs are widely used in the control system of temperature, flow, liquid level, pressure.

1-1-1. Module type and names

The detailed information is:

Model	Function
XD-EnXmY	N points input, m points output, PNP/NPN input, relay/transistor output
XD-E4AD2DA	4 channels analog input (14bits); 2 channels analog output (12bits); input and output are all current/voltage selectable
XD-E4AD2DA-B	4 channels analog input (14bits), current/voltage selectable; 2 channels voltage output (12bits), -10V~10V, -5V~5V selectable;
XD-E4AD	4 channels analog input (14 bits), current/voltage selectable
XD-E8AD	8 channels analog input (14 bits), current/voltage selectable
XD-E2DA	2 channels analog output (12 bits), current/voltage selectable
XD-E4DA	4 channels analog output (12 bits), current/voltage selectable
XD-E1WT-A	1 channel pressure control module, detection range DC -39.06mV~39.06mV
XD-E2WT-A	2 channel pressure control module, detection range DC -39.06mV~39.06mV
XD-E4WT-A	4 channel pressure control module, detection range DC -39.06mV~39.06mV
XD-E2WT-B	2 channel pressure control module, detection range DC 0mV~10mV
XD-E1WT-C	1 channel pressure control module, detection range DC 0mV~10mV
XD-E2WT-C	2 channel pressure control module, detection range DC 0mV~10mV
XD-E4WT-C	4 channel pressure control module, detection range DC 0mV~10mV
XD-E1WT-D	1 channel pressure control module, detection range DC 0mV~10mV
XD-E2WT-D	2 channel pressure control module, detection range DC 0mV~10mV
XD-E4WT-D	4 channel pressure control module, detection range DC 0mV~10mV
XD-E6PT-P	6 channels PT100 temperature control module, with PID function
XD-E4PT3-P	4 channels PT100 (3-wire mode) temperature control module, with PID function
XD-E6TC-P	6 channels thermocouple temperature control module, with PID function
XD-E2TC-P	2 channels thermocouple temperature control module, with PID function
XD-E4SSI	4-channel SSI encoder position detection or displacement sensor position detection
XD-E2AD2PT2DA	2-channel analog output (16-bit), 2-channel PT100 temperature measurement, 2-channel analog output (10-bit); input and output voltage

	and current are optional
XD-E3AD4PT2DA	3-channel analog output (14-bit), 4-channel PT100 temperature measurement, 2-channel analog output (10-bit); input current and output voltage are optional

1-1-2. Module configuration

XD series expansion modules can be connected to the right side of PLC:

- Digital input, output terminal no. is octal number.
- Analog input, output terminal no. is decimal number.
- Up to 10 expansion modules can be connected to XD3 series PLC.
- Up to 16 expansion modules can be connect to XD5/XDM/XDC/XD5E/XDME series PLC.
- XD1 and XD2 series cannot support expansion module.

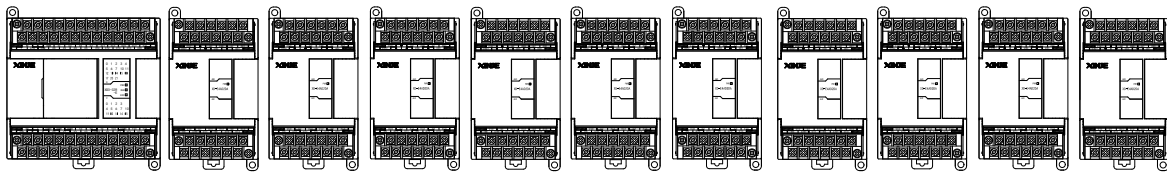

1-1-3. Terminal resistor XD-ETR

When the number of XD series PLC external right expansion modules is more than or equal to 5, terminal resistor module XD-ETR should be used together.

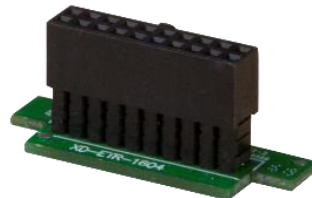

When using, please install XD-ETR on the expansion port of the rightmost module, as shown in the figure below:

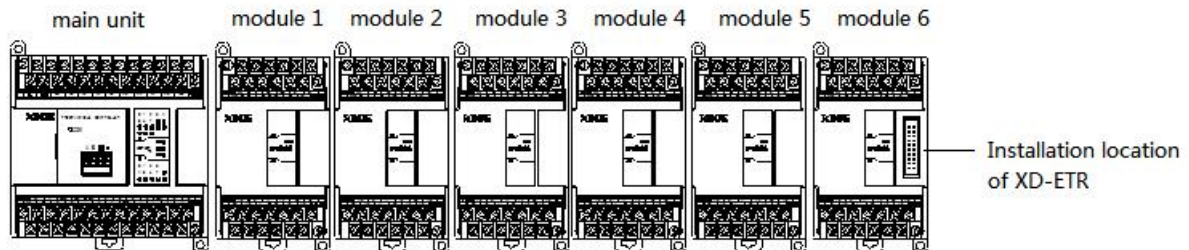

1-2. Dimensions

Analog, temperature, pressure modules, encoder detection, 8/16 points I/O modules: (dimension: mm)

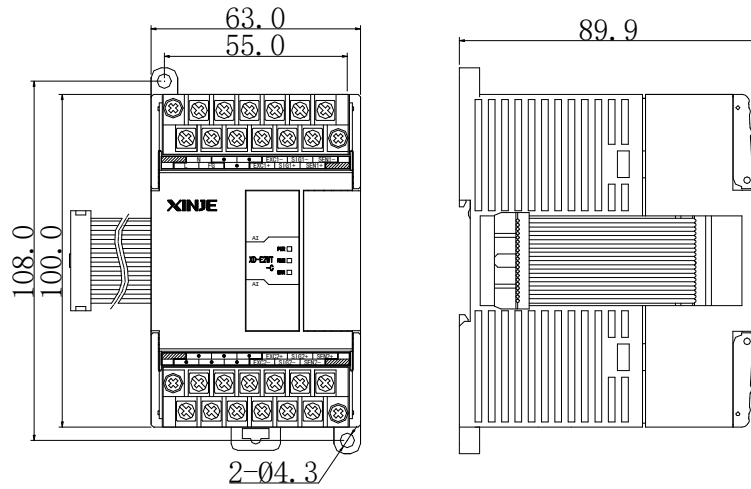

32 points I/O modules, XD-E4WT-C, XD-E4WT-D module: (dimension: mm)

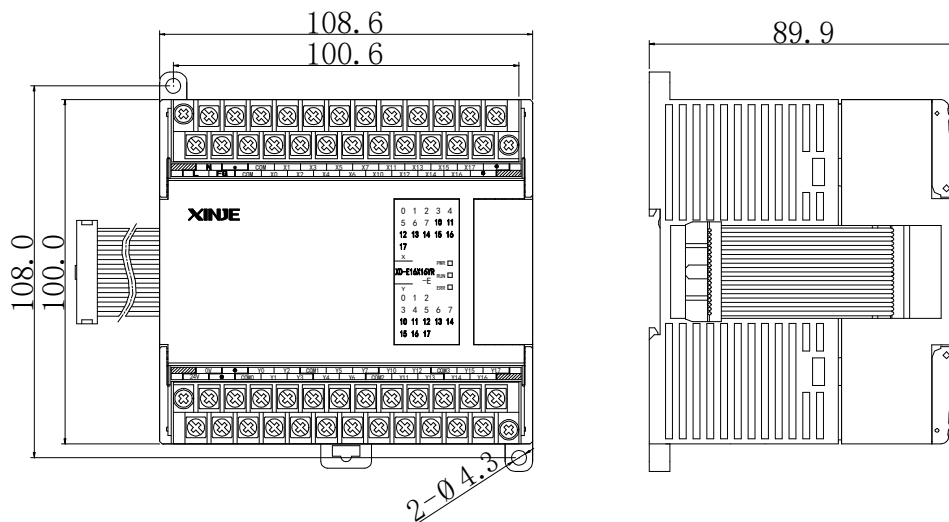

1-3. Module part name and function

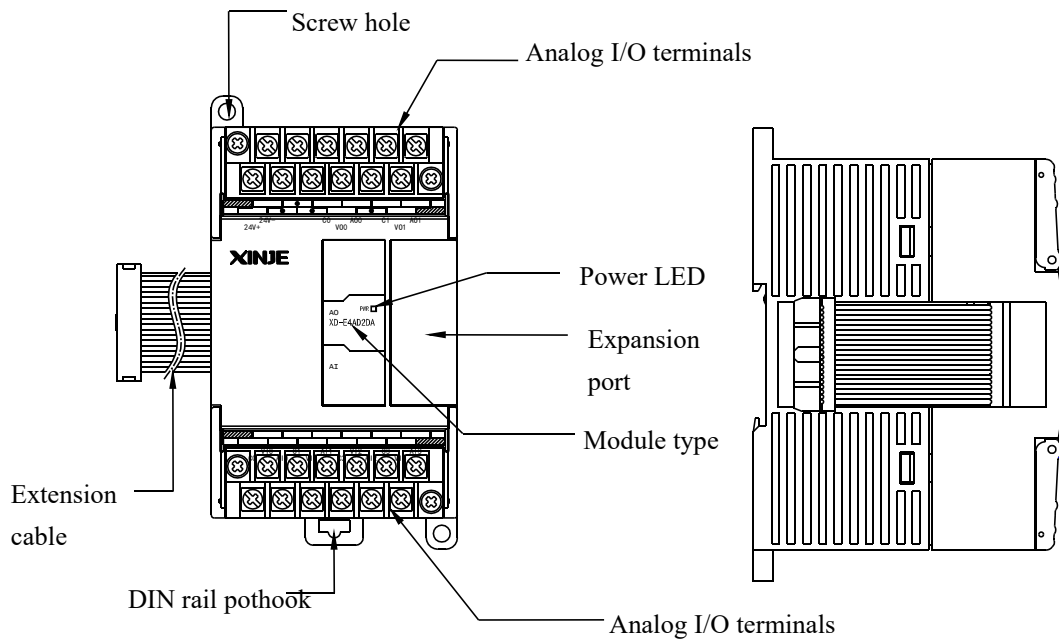

Name		Function
Operation indicator	PWR	When the module has power supply, the indicator is on
	RUN	When the module communication port communicates normally, the indicator will be on
	ERR	When there is an error in the module, the indicator is always on or flashing (red). When the ERR light is always on, it means that the module has serious application error and can not be used, so the use mode must be adjusted, and the PLC body is switched to the stop state; when the err light is flashing, it means that the module has application error, abnormal work and abnormal data, but the PLC body is still run.
Module type		The type of expansion module
Expansion port		To connect the expansion module
Analog I/O terminals		To connect to analog input and output, the terminals are knock-down
DIN rail pothook		To mount the module, pull down the pothook to take away the module
Screw hole		Use M3 screw
Expansion cable		To connect the expansion module

Note: The operation indicator of some models or lower version of models is only PWR.

1-4. General specifications

Operating Environment	No corrosive gas
Ambient Temperature	0°C~60°C
Store Temperature	-20~70°C
Ambient Humidity	5~95% RH
Store Humidity	5~95% RH
Installation	Can be fixed with M3 screw or directly installed on DIN46277 rail (width: 35mm)

1-5. Module power and service conditions

XD series right expansion module can be used normally only when the internal and external power of PLC minus the internal and external power of module is greater than or equal to 0; if the PLC is equipped with BD board or ED module, the internal and external power consumed also needs to be subtracted; if the right expansion module and ED module use external power supply, the external power of PLC does not need to be subtracted.

Module power list

Module name	Internal power (extension cable)	External power (power supply terminal)
XD-E8X	0.6W	1.3W
XD-E8YR	2.2W	0
XD-E8YT	1.3W	0
XD-E8X8YR	2.2W	1.3W
XD-E8X8YT	1.5W	1.3W
XD-E16X	0.8W	2.5W
XD-E16YR	3.5W	0
XD-E16YT	2.3W	0
XD-E16X16YR-E/C	0	7W
XD-E16X16YT-E/C	0	5.5W
XD-E32YR-E/C	0	7W
XD-E32YT-E/C	0	4.5W
XD-E32X-E/C	0	7W
XD-E4AD2DA	0.7W	1.5W
XD-E4AD	0.7W	0.3W
XD-E8AD	0.7W	0.3W
XD-E8AD-A	0.7W	0.3W
XD-E8AD-V	0.7W	0.3W
XD-E2DA	0.7W	1.2W
XD-E4DA	0.7W	2W

XD-E6TC-P	0.7W	0.3W
XD-E6PT-P	0.7W	0.3W
XD-E2TC-P	0.7W	0.3W
XD-E2GRP	1.5W	6W
XD-E4SSI	1W	4W
XD-E1WT-A	0.7W	0.5W
XD-E2WT-A	0.7W	1W
XD-E4WT-A	0.7W	2W
XD-E2WT-B	0.7W	1W
XD-E2WT-C	0.7W	Only can use external power supply of AC 220 V, cannot use PLC internal power supply DC 24V
XD-E4WT-C	0.7W	
XD-E1WT-D	0.7W	0.5W
XD-E2WT-D	0.7W	1W
XD-E4WT-D	0.7W	2W

PLC power list

PLC model	Internal power	External power
16 points PLC	5~6W	6W
24 points PLC	10.5~12.5W	12.5W
32 points PLC	10~12W	12W
48 points PLC	9.5~11.5W	9.5W
60 points PLC	9~11W	8W

Others

Model	Internal power	External power
XD-2AD2PT-V-ED and other analog ED	Very small, can be neglected	0.5~2.5W
XD-NES-ED	1W	-
BOX-ED	Very small, can be neglected	0.5~2.5W
XD-NE-BD	1W	-

1-6 Module installation

XD series expansion module can be connected to the right side of PLC. Fix the module on the DIN46277 rail or with screw M3.

DIN46277 rail:

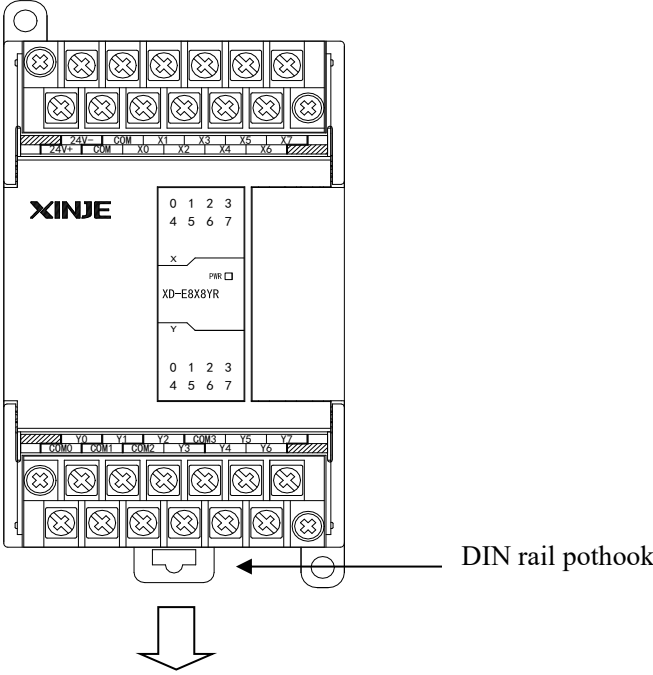

The module can be mounted on the DIN46277 rail (width 35mm). Pull down the DIN rail pothook to uninstall the module.

Direct installation: put the screw (M3) to fix the module.

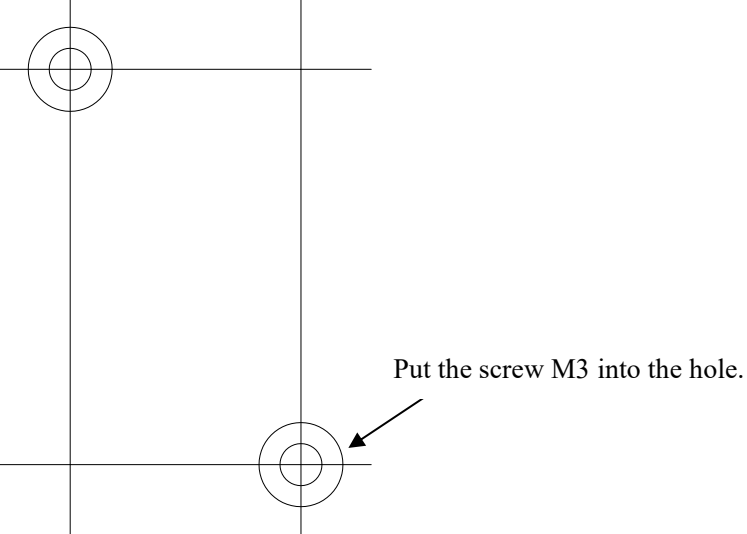

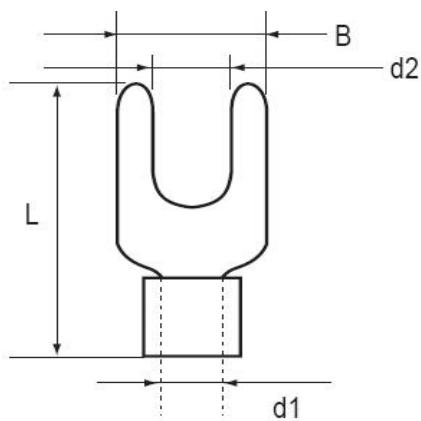

Terminal wiring:

■ Y terminal

Y terminal dimension

B: Y outer dimension

d1: Outer diameter connecting to the wire

d2: Internal diameter (press the screw)

L: Whole length

Suitable dimension:

B: below 6mm L: below 13mm

d2: below 3.2mm

■ Wiring method

A. Cut off the power supply

B. Open the front cover

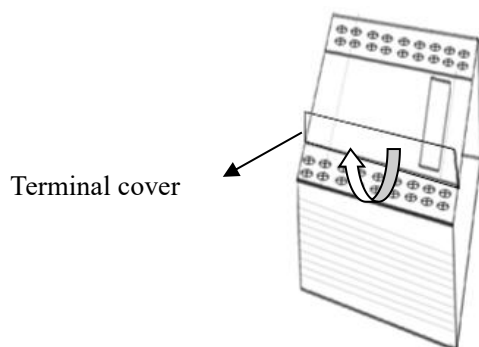

C. Put the terminal of signal wire on the I/O terminal tightens the screw.

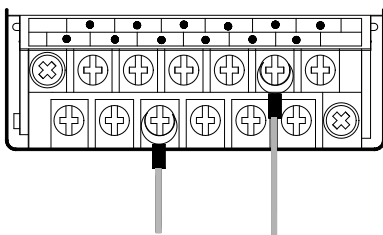

D. Close the I/O terminal cover

Notes:

1. Confirm the specification of the module
2. The scraps cannot fall into the module when wiring
3. Before wiring, confirm the specifications of module and device again
4. Make sure the wire connection is firm, otherwise data incorrectness and circuit shorting will happen
5. Cut the power before Installation and wiring

1-7. Configure the module

Before using the expansion module, please configure the module in XDPpro software.

Next we will introduce the configuration steps. Take XD-E4AD2DA as an example.

- A. Open the XDPpro software, click Configure/expansion module settings.

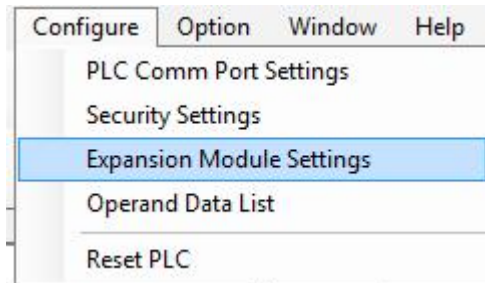

- B. Choose the module type and channel parameters in the following window. Then click write to PLC.

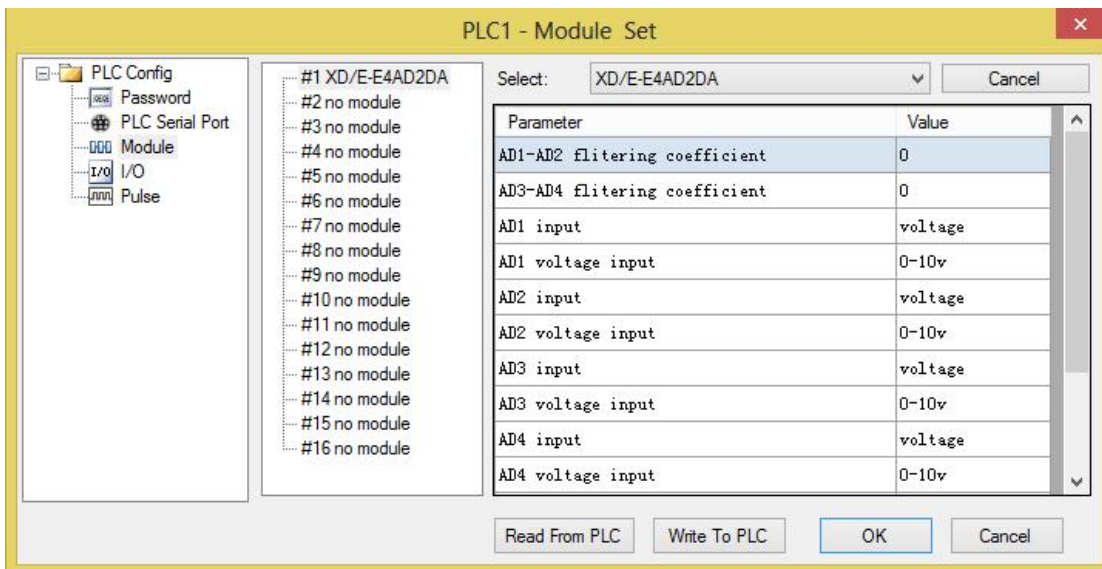

- C. Cut the PLC power supply and give the power again to make the setting effective.

2. I/O expansion module XD-EnXmY

2-1. Specifications

XD-EnXmY is the extension module of XD series, up to 10 XD-EnXmY modules can be connected to XD3/XD3E series PLC (up to 16 modules for XD5/XDM/XDC/XD5E/XDME/XDH series PLC). This module has rich types, small size, and more I/O points which can meet more requirements.

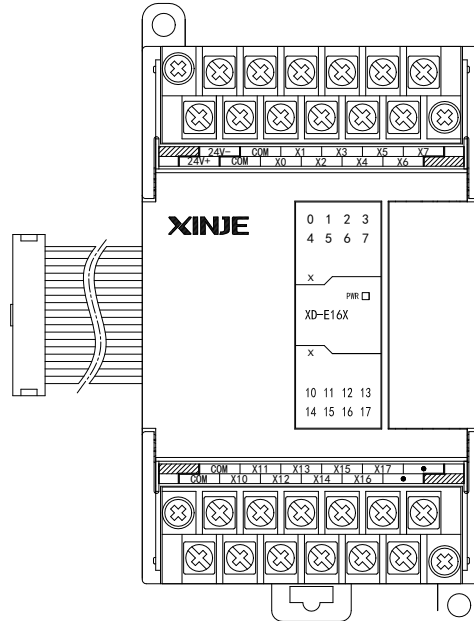

Module types

Model		Function
NPN input	PNP input	
XD-E8X	XD-E8PX	8 channels digital input
XD-E8YR	-	8 channels relay output
XD-E8YT	-	8 channels transistor output
XD-E8X8YR	XD-E8PX8YR	8 channels digital input, 8 channels relay output
XD-E8X8YT	XD-E8PX8YT	8 channels digital input, 8 channels transistor output
XD-E16X	XD-E16PX	16 channels digital input
XD-E16YR	-	16 channels relay output
XD-E16YT	-	16 channels transistor output
XD-E16X16YR-E	XD-E16PX16YR-E	16 channels digital input, 16 channels relay output, AC220V
XD-E16X16YR-C	XD-E16PX16YR-C	16 channels digital input, 16 channels relay output, DC24V
XD-E16X16YT-E	XD-E16PX16YT-E	16 channels digital input, 16 channels transistor output, AC220V
XD-E16X16YT-C	XD-E16PX16YT-C	16 channels digital input, 16 channels transistor output, DC24V
XD-E32YR-E	-	32 channels relay output, AC220V
XD-E32YR-C	-	32 channels relay output, DC24V
XD-E32YT-E	-	32 channels transistor output, AC220V

XD-E32YT-C	-	32 channels transistor output, DC24V
XD-E32X-E	XD-E32PX-E	32 channels digital input, AC220V
XD-E32X-C	XD-E32PX-C	32 channels digital input, DC24V

Module Specifications

Items	Specifications
Input voltage (Power supply)	DC24V ± 10% (32 points module is AC220V ± 10%)
Application environment	No corrosive gas
Environment temperature	0°C ~ 60°C
Environment humidity	5~95%
Installation	Fixed with M3 screws or directly installed on DIN46277 rail (Width: 35mm)
Dimension	8~16 points module: 63mm × 108mm × 89.9mm 32 points module: 108.6mm × 108mm × 89.9mm

2-2. Terminals

The terminals distributions of NPN and PNP input are the same.

(1) XD-E8X

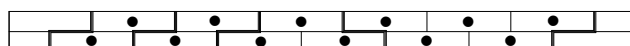
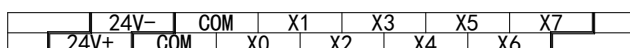

(2) XD-E8YR, XD-E8YT

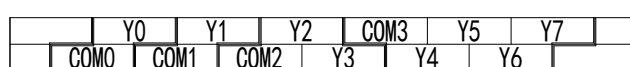
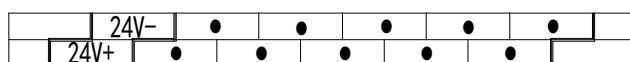

(3) XD-E8X8YR, XD-E8X8YT

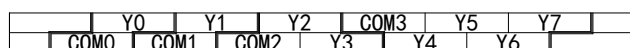
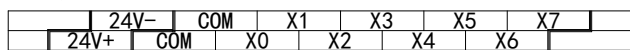

(4) XD-E16X

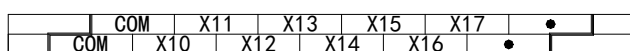
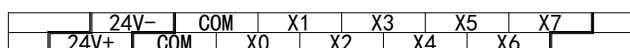

(5) XD-E16YR, XD-E16YT

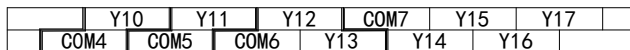
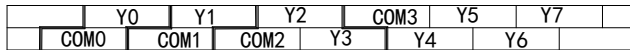

(6) XD-E16X16YR/T-E

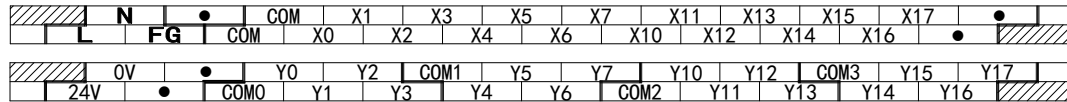

(7) XD-E16X16YR/T-C

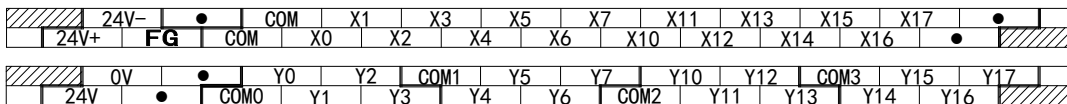

(8) XD-E32YR/T-E

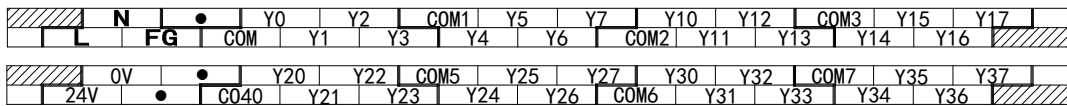

(9) XD-E32YR/T-C

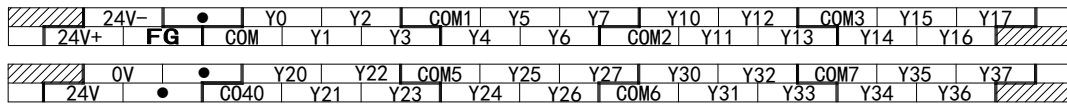

(10) XD-E32X-E

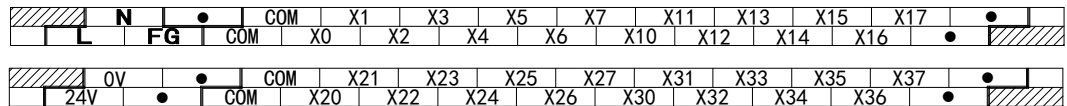

(11) XD-E32X-C

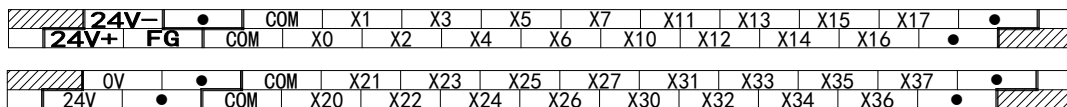

Caution: Maybe the common terminal of each module is different from above pictures; please see the label of actual objects.

2-3. I/O address assignment

XD3 series can expand 10 modules, XD5/XDM/XDC/XD5E/XDME series PLC can expand 16 modules. The address of I/O terminals are shown as below:

(Caution: Take NPN type as an example, the terminals definition, address, suitable module of PNP are the same as NPN)

- **XD-E8X8YR, XD-E8X8YT**

Expansion module no.1 to no.16 terminal address:

	X0	X1	X2	X3	X4	X5	X6	X7
Expansion module no.1	X10000	X10001	X10002	X10003	X10004	X10005	X10006	X10007
Expansion module no.2	X10100	X10101	X10102	X10103	X10104	X10105	X10106	X10107
Expansion module no.3	X10200	X10201	X10202	X10203	X10204	X10205	X10206	X10207
Expansion module no.4	X10300	X10301	X10302	X10303	X10304	X10305	X10306	X10307
Expansion module no.5	X10400	X10401	X10402	X10403	X10404	X10405	X10406	X10407
Expansion module no.6	X10500	X10501	X10502	X10503	X10504	X10505	X10506	X10507
Expansion module no.7	X10600	X10601	X10602	X10603	X10604	X10605	X10606	X10607
Expansion module no.8	X10700	X10701	X10702	X10703	X10704	X10705	X10706	X10707
Expansion module no.9	X11000	X11001	X11002	X11003	X11004	X11005	X11006	X11007
Expansion module no.10	X11100	X11101	X11102	X11103	X11104	X11105	X11106	X11107
Expansion module no.11	X11200	X11201	X11202	X11203	X11204	X11205	X11206	X11207
Expansion module no.12	X11300	X11301	X11302	X11303	X11304	X11305	X11306	X11307
Expansion module no.13	X11400	X11401	X11402	X11403	X11404	X11405	X11406	X11407
Expansion module no.14	X11500	X11501	X11502	X11503	X11504	X11505	X11506	X11507
Expansion module no.15	X11600	X11601	X11602	X11603	X11604	X11605	X11606	X11607
Expansion module no.16	X11700	X11701	X11702	X11703	X11704	X11705	X11706	X11707

	Y0	Y1	Y2	Y3	Y4	Y5	Y6	Y7
Expansion module no.1	Y10000	Y10001	Y10002	Y10003	Y10004	Y10005	Y10006	Y10007
Expansion module no.2	Y10100	Y10101	Y10102	Y10103	Y10104	Y10105	Y10106	Y10107
Expansion module no.3	Y10200	Y10201	Y10202	Y10203	Y10204	Y10205	Y10206	Y10207
Expansion module no.4	Y10300	Y10301	Y10302	Y10303	Y10304	Y10305	Y10306	Y10307
Expansion module no.5	Y10400	Y10401	Y10402	Y10403	Y10404	Y10405	Y10406	Y10407
Expansion module no.6	Y10500	Y10501	Y10502	Y10503	Y10504	Y10505	Y10506	Y10507
Expansion module no.7	Y10600	Y10601	Y10602	Y10603	Y10604	Y10605	Y10606	Y10607
Expansion module no.8	Y10700	Y10701	Y10702	Y10703	Y10704	Y10705	Y10706	Y10707
Expansion module no.9	Y11000	Y11001	Y11002	Y11003	Y11004	Y11005	Y11006	Y11007
Expansion module no.10	Y11100	Y11101	Y11102	Y11103	Y11104	Y11105	Y11106	Y11107
Expansion module no.11	Y11200	Y11201	Y11202	Y11203	Y11204	Y11205	Y11206	Y11207
Expansion module no.12	Y11300	Y11301	Y11302	Y11303	Y11304	Y11305	Y11306	Y11307
Expansion module no.13	Y11400	Y11401	Y11402	Y11403	Y11404	Y11405	Y11406	Y11407
Expansion module no.14	Y11500	Y11501	Y11502	Y11503	Y11504	Y11505	Y11506	Y11507
Expansion module no.15	Y11600	Y11601	Y11602	Y11603	Y11604	Y11605	Y11606	Y11607
Expansion module no.16	Y11700	Y11701	Y11702	Y11703	Y11704	Y11705	Y11706	Y11707

- **XD-E8X**

Expansion module no.1 to no.16 terminal address:

	X0	X1	X2	X3	X4	X5	X6	X7
Expansion module no.1	X10000	X10001	X10002	X10003	X10004	X10005	X10006	X10007
Expansion module no.2	X10100	X10101	X10102	X10103	X10104	X10105	X10106	X10107
Expansion module no.3	X10200	X10201	X10202	X10203	X10204	X10205	X10206	X10207
Expansion module no.4	X10300	X10301	X10302	X10303	X10304	X10305	X10306	X10307
Expansion module no.5	X10400	X10401	X10402	X10403	X10404	X10405	X10406	X10407
Expansion module no.6	X10500	X10501	X10502	X10503	X10504	X10505	X10506	X10507
Expansion module no.7	X10600	X10601	X10602	X10603	X10604	X10605	X10606	X10607
Expansion module no.8	X10700	X10701	X10702	X10703	X10704	X10705	X10706	X10707
Expansion module no.9	X11000	X11001	X11002	X11003	X11004	X11005	X11006	X11007
Expansion module no.10	X11100	X11101	X11102	X11103	X11104	X11105	X11106	X11107
Expansion module no.11	X11200	X11201	X11202	X11203	X11204	X11205	X11206	X11207
Expansion module no.12	X11300	X11301	X11302	X11303	X11304	X11305	X11306	X11307
Expansion module no.13	X11400	X11401	X11402	X11403	X11404	X11405	X11406	X11407
Expansion module no.14	X11500	X11501	X11502	X11503	X11504	X11505	X11506	X11507
Expansion module no.15	X11600	X11601	X11602	X11603	X11604	X11605	X11606	X11607
Expansion module no.16	X11700	X11701	X11702	X11703	X11704	X11705	X11706	X11707

- XD-E8YR, XD-E8YT

Expansion module no.1 to no.16 terminal address:

	Y0	Y1	Y2	Y3	Y4	Y5	Y6	Y7
Expansion module no.1	Y10000	Y10001	Y10002	Y10003	Y10004	Y10005	Y10006	Y10007
Expansion module no.2	Y10100	Y10101	Y10102	Y10103	Y10104	Y10105	Y10106	Y10107
Expansion module no.3	Y10200	Y10201	Y10202	Y10203	Y10204	Y10205	Y10206	Y10207
Expansion module no.4	Y10300	Y10301	Y10302	Y10303	Y10304	Y10305	Y10306	Y10307
Expansion module no.5	Y10400	Y10401	Y10402	Y10403	Y10404	Y10405	Y10406	Y10407
Expansion module no.6	Y10500	Y10501	Y10502	Y10503	Y10504	Y10505	Y10506	Y10507
Expansion module no.7	Y10600	Y10601	Y10602	Y10603	Y10604	Y10605	Y10606	Y10607
Expansion module no.8	Y10700	Y10701	Y10702	Y10703	Y10704	Y10705	Y10706	Y10707
Expansion module no.9	Y11000	Y11001	Y11002	Y11003	Y11004	Y11005	Y11006	Y11007
Expansion module no.10	Y11100	Y11101	Y11102	Y11103	Y11104	Y11105	Y11106	Y11107
Expansion module no.11	Y11200	Y11201	Y11202	Y11203	Y11204	Y11205	Y11206	Y11207
Expansion module no.12	Y11300	Y11301	Y11302	Y11303	Y11304	Y11305	Y11306	Y11307
Expansion module no.13	Y11400	Y11401	Y11402	Y11403	Y11404	Y11405	Y11406	Y11407
Expansion module no.14	Y11500	Y11501	Y11502	Y11503	Y11504	Y11505	Y11506	Y11507
Expansion module no.15	Y11600	Y11601	Y11602	Y11603	Y11604	Y11605	Y11606	Y11607
Expansion module no.16	Y11700	Y11701	Y11702	Y11703	Y11704	Y11705	Y11706	Y11707

• **XD-E16X**

Expansion module no.1 to no.16 input terminal address:

	Expansion module no.1	Expansion module no.2	Expansion module no.3	Expansion module no.4	Expansion module no.5	Expansion module no.6	Expansion module no.7	Expansion module no.8	Expansion module no.9	Expansion module no.10
X0	X10000	X10100	X10200	X10300	X10400	X10500	X10600	X10700	X11000	X11100
X1	X10001	X10101	X10201	X10301	X10401	X10501	X10601	X10701	X11001	X11101
X2	X10002	X10102	X10202	X10302	X10402	X10502	X10602	X10702	X11002	X11102
X3	X10003	X10103	X10203	X10303	X10403	X10503	X10603	X10703	X11003	X11103
X4	X10004	X10104	X10204	X10304	X10404	X10504	X10604	X10704	X11004	X11104
X5	X10005	X10105	X10205	X10305	X10405	X10505	X10605	X10705	X11005	X11105
X6	X10006	X10106	X10206	X10306	X10406	X10506	X10606	X10706	X11006	X11106
X7	X10007	X10107	X10207	X10307	X10407	X10507	X10607	X10707	X11007	X11107
X10	X10010	X10110	X10210	X10310	X10410	X10510	X10610	X10710	X11010	X11110
X11	X10011	X10111	X10211	X10311	X10411	X10511	X10611	X10711	X11011	X11111
X12	X10012	X10112	X10212	X10312	X10412	X10512	X10612	X10712	X11012	X11112
X13	X10013	X10113	X10213	X10313	X10413	X10513	X10613	X10713	X11013	X11113
X14	X10014	X10114	X10214	X10314	X10414	X10514	X10614	X10714	X11014	X11114
X15	X10015	X10115	X10215	X10315	X10415	X10515	X10615	X10715	X11015	X11115
X16	X10016	X10116	X10216	X10316	X10416	X10516	X10616	X10716	X11016	X11116
X17	X10017	X10117	X10217	X10317	X10417	X10517	X10617	X10717	X11017	X11117
	Expansion module no.11	Expansion module no.12	Expansion module no.13	Expansion module no.14	Expansion module no.15	Expansion module no.16				
X0	X11200	X11300	X11400	X11500	X11600	X11700				
X1	X11201	X11301	X11401	X11501	X11600	X11701				
X2	X11202	X11302	X11402	X11502	X11602	X11702				
X3	X11203	X11303	X11403	X11503	X11603	X11703				
X4	X11204	X11304	X11404	X11504	X11604	X11704				
X5	X11205	X11305	X11405	X11505	X11605	X11705				
X6	X11206	X11306	X11406	X11506	X11606	X11706				
X7	X11207	X11307	X11407	X11507	X11607	X11707				
X10	X11210	X11310	X11410	X11510	X11610	X11710				
X11	X11211	X11311	X11411	X11511	X11611	X11711				
X12	X11212	X11312	X11412	X11512	X11612	X11712				
X13	X11213	X11313	X11413	X11513	X11613	X11713				
X14	X11214	X11314	X11414	X11514	X11614	X11714				
X15	X11215	X11315	X11415	X11515	X11615	X11715				
X16	X11216	X11316	X11416	X11516	X11616	X11716				
X17	X11217	X11317	X11417	X11517	X11617	X11717				

- **XD-E16Y**

Expansion module no.1 to no.16 input terminal address:

	Expansion module no.1	Expansion module no.2	Expansion module no.3	Expansion module no.4	Expansion module no.5	Expansion module no.6	Expansion module no.7	Expansion module no.8	Expansion module no.9	Expansion module no.10
Y0	Y10000	Y10100	Y10200	Y10300	Y10400	Y10500	Y10600	Y10700	Y11000	Y11100
Y1	Y10001	Y10101	Y10201	Y10301	Y10401	Y10501	Y10601	Y10701	Y11001	Y11101
Y2	Y10002	Y10102	Y10202	Y10302	Y10402	Y10502	Y10602	Y10702	Y11002	Y11102
Y3	Y10003	Y10103	Y10203	Y10303	Y10403	Y10503	Y10603	Y10703	Y11003	Y11103
Y4	Y10004	Y10104	Y10204	Y10304	Y10404	Y10504	Y10604	Y10704	Y11004	Y11104
Y5	Y10005	Y10105	Y10205	Y10305	Y10405	Y10505	Y10605	Y10705	Y11005	Y11105
Y6	Y10006	Y10106	Y10206	Y10306	Y10406	Y10506	Y10606	Y10706	Y11006	Y11106
Y7	Y10007	Y10107	Y10207	Y10307	Y10407	Y10507	Y10607	Y10707	Y11007	Y11107
Y10	Y10010	Y10110	Y10210	Y10310	Y10410	Y10510	Y10610	Y10710	Y11010	Y11110
Y11	Y10011	Y10111	Y10211	Y10311	Y10411	Y10511	Y10611	Y10711	Y11011	Y11111
Y12	Y10012	Y10112	Y10212	Y10312	Y10412	Y10512	Y10612	Y10712	Y11012	Y11112
Y13	Y10013	Y10113	Y10213	Y10313	Y10413	Y10513	Y10613	Y10713	Y11013	Y11113
Y14	Y10014	Y10114	Y10214	Y10314	Y10414	Y10514	Y10614	Y10714	Y11014	Y11114
Y15	Y10015	Y10115	Y10215	Y10315	Y10415	Y10515	Y10615	Y10715	Y11015	Y11115
Y16	Y10016	Y10116	Y10216	Y10316	Y10416	Y10516	Y10616	Y10716	Y11016	Y11116
Y17	Y10017	Y10117	Y10217	Y10317	Y10417	Y10517	Y10617	Y10717	Y11017	Y11117
	Expansion module no.11	Expansion module no.12	Expansion module no.13	Expansion module no.14	Expansion module no.15	Expansion module no.16				
Y0	Y11200	Y11300	Y11400	Y11500	Y11600	Y11700				
Y1	Y11201	Y11301	Y11401	Y11501	Y11600	Y11701				
Y2	Y11202	Y11302	Y11402	Y11502	Y11602	Y11702				
Y3	Y11203	Y11303	Y11403	Y11503	Y11603	Y11703				
Y4	Y11204	Y11304	Y11404	Y11504	Y11604	Y11704				
Y5	Y11205	Y11305	Y11405	Y11505	Y11605	Y11705				
Y6	Y11206	Y11306	Y11406	Y11506	Y11606	Y11706				
Y7	Y11207	Y11307	Y11407	Y11507	Y11607	Y11707				
Y10	Y11210	Y11310	Y11410	Y11510	Y11610	Y11710				
Y11	Y11211	Y11311	Y11411	Y11511	Y11611	Y11711				
Y12	Y11212	Y11312	Y11412	Y11512	Y11612	Y11712				
Y13	Y11213	Y11313	Y11413	Y11513	Y11613	Y11713				
Y14	Y11214	Y11314	Y11414	Y11514	Y11614	Y11714				
Y15	Y11215	Y11315	Y11415	Y11515	Y11615	Y11715				
Y16	Y11216	Y11316	Y11416	Y11516	Y11616	Y11716				
Y17	Y11217	Y11317	Y11417	Y11517	Y11617	Y11717				

• **XD-E16X16Y**

Expansion module no.1 to no.16 input terminal address:

	Expansion module no.1	Expansion module no.2	Expansion module no.3	Expansion module no.4	Expansion module no.5	Expansion module no.6	Expansion module no.7	Expansion module no.8	Expansion module no.9	Expansion module no.10
X0	X10000	X10100	X10200	X10300	X10400	X10500	X10600	X10700	X11000	X11100
X1	X10001	X10101	X10201	X10301	X10401	X10501	X10601	X10701	X11001	X11101
X2	X10002	X10102	X10202	X10302	X10402	X10502	X10602	X10702	X11002	X11102
X3	X10003	X10103	X10203	X10303	X10403	X10503	X10603	X10703	X11003	X11103
X4	X10004	X10104	X10204	X10304	X10404	X10504	X10604	X10704	X11004	X11104
X5	X10005	X10105	X10205	X10305	X10405	X10505	X10605	X10705	X11005	X11105
X6	X10006	X10106	X10206	X10306	X10406	X10506	X10606	X10706	X11006	X11106
X7	X10007	X10107	X10207	X10307	X10407	X10507	X10607	X10707	X11007	X11107
X10	X10010	X10110	X10210	X10310	X10410	X10510	X10610	X10710	X11010	X11110
X11	X10011	X10111	X10211	X10311	X10411	X10511	X10611	X10711	X11011	X11111
X12	X10012	X10112	X10212	X10312	X10412	X10512	X10612	X10712	X11012	X11112
X13	X10013	X10113	X10213	X10313	X10413	X10513	X10613	X10713	X11013	X11113
X14	X10014	X10114	X10214	X10314	X10414	X10514	X10614	X10714	X11014	X11114
X15	X10015	X10115	X10215	X10315	X10415	X10515	X10615	X10715	X11015	X11115
X16	X10016	X10116	X10216	X10316	X10416	X10516	X10616	X10716	X11016	X11116
X17	X10017	X10117	X10217	X10317	X10417	X10517	X10617	X10717	X11017	X11117
	Expansion module no.11	Expansion module no.12	Expansion module no.13	Expansion module no.14	Expansion module no.15	Expansion module no.16				
X0	X11200	X11300	X11400	X11500	X11600	X11700				
X1	X11201	X11301	X11401	X11501	X11600	X11701				
X2	X11202	X11302	X11402	X11502	X11602	X11702				
X3	X11203	X11303	X11403	X11503	X11603	X11703				
X4	X11204	X11304	X11404	X11504	X11604	X11704				
X5	X11205	X11305	X11405	X11505	X11605	X11705				
X6	X11206	X11306	X11406	X11506	X11606	X11706				
X7	X11207	X11307	X11407	X11507	X11607	X11707				
X10	X11210	X11310	X11410	X11510	X11610	X11710				
X11	X11211	X11311	X11411	X11511	X11611	X11711				
X12	X11212	X11312	X11412	X11512	X11612	X11712				
X13	X11213	X11313	X11413	X11513	X11613	X11713				
X14	X11214	X11314	X11414	X11514	X11614	X11714				
X15	X11215	X11315	X11415	X11515	X11615	X11715				
X16	X11216	X11316	X11416	X11516	X11616	X11716				
X17	X11217	X11317	X11417	X11517	X11617	X11717				

	Expansion module no.1	Expansion module no.2	Expansion module no.3	Expansion module no.4	Expansion module no.5	Expansion module no.6	Expansion module no.7	Expansion module no.8	Expansion module no.9	Expansion module no.10
Y0	Y10000	Y10100	Y10200	Y10300	Y10400	Y10500	Y10600	Y10700	Y11000	Y11100
Y1	Y10001	Y10101	Y10201	Y10301	Y10401	Y10501	Y10601	Y10701	Y11001	Y11101
Y2	Y10002	Y10102	Y10202	Y10302	Y10402	Y10502	Y10602	Y10702	Y11002	Y11102
Y3	Y10003	Y10103	Y10203	Y10303	Y10403	Y10503	Y10603	Y10703	Y11003	Y11103
Y4	Y10004	Y10104	Y10204	Y10304	Y10404	Y10504	Y10604	Y10704	Y11004	Y11104
Y5	Y10005	Y10105	Y10205	Y10305	Y10405	Y10505	Y10605	Y10705	Y11005	Y11105
Y6	Y10006	Y10106	Y10206	Y10306	Y10406	Y10506	Y10606	Y10706	Y11006	Y11106
Y7	Y10007	Y10107	Y10207	Y10307	Y10407	Y10507	Y10607	Y10707	Y11007	Y11107
Y10	Y10010	Y10110	Y10210	Y10310	Y10410	Y10510	Y10610	Y10710	Y11010	Y11110
Y11	Y10011	Y10111	Y10211	Y10311	Y10411	Y10511	Y10611	Y10711	Y11011	Y11111
Y12	Y10012	Y10112	Y10212	Y10312	Y10412	Y10512	Y10612	Y10712	Y11012	Y11112
Y13	Y10013	Y10113	Y10213	Y10313	Y10413	Y10513	Y10613	Y10713	Y11013	Y11113
Y14	Y10014	Y10114	Y10214	Y10314	Y10414	Y10514	Y10614	Y10714	Y11014	Y11114
Y15	Y10015	Y10115	Y10215	Y10315	Y10415	Y10515	Y10615	Y10715	Y11015	Y11115
Y16	Y10016	Y10116	Y10216	Y10316	Y10416	Y10516	Y10616	Y10716	Y11016	Y11116
Y17	Y10017	Y10117	Y10217	Y10317	Y10417	Y10517	Y10617	Y10717	Y11017	X11117
	Expansion module no.11	Expansion module no.12	Expansion module no.13	Expansion module no.14	Expansion module no.15	Expansion module no.16				
Y0	Y11200	Y11300	Y11400	Y11500	Y11600	Y11700				
Y1	Y11201	Y11301	Y11401	Y11501	Y11600	Y11701				
Y2	Y11202	Y11302	Y11402	Y11502	Y11602	Y11702				
Y3	Y11203	Y11303	Y11403	Y11503	Y11603	Y11703				
Y4	Y11204	Y11304	Y11404	Y11504	Y11604	Y11704				
Y5	Y11205	Y11305	Y11405	Y11505	Y11605	Y11705				
Y6	Y11206	Y11306	Y11406	Y11506	Y11606	Y11706				
Y7	Y11207	Y11307	Y11407	Y11507	Y11607	Y11707				
Y10	Y11210	Y11310	Y11410	Y11510	Y11610	Y11710				
Y11	Y11211	Y11311	Y11411	Y11511	Y11611	Y11711				
Y12	Y11212	Y11312	Y11412	Y11512	Y11612	Y11712				
Y13	Y11213	Y11313	Y11413	Y11513	Y11613	Y11713				
Y14	Y11214	Y11314	Y11414	Y11514	Y11614	Y11714				
Y15	Y11215	Y11315	Y11415	Y11515	Y11615	Y11715				
Y16	Y11216	Y11316	Y11416	Y11516	Y11616	Y11716				
Y17	Y11217	Y11317	Y11417	Y11517	Y11617	Y11717				

- **XD-E32Y**

Expansion module no.1 to no.16 input terminal address:

	Expansion module no.1	Expansion module no.2	Expansion module no.3	Expansion module no.4	Expansion module no.5	Expansion module no.6	Expansion module no.7	Expansion module no.8	Expansion module no.9	Expansion module no.10
Y0	Y10000	Y10100	Y10200	Y10300	Y10400	Y10500	Y10600	Y10700	Y11000	Y11100
Y1	Y10001	Y10101	Y10201	Y10301	Y10401	Y10501	Y10601	Y10701	Y11001	Y11101
Y2	Y10002	Y10102	Y10202	Y10302	Y10402	Y10502	Y10602	Y10702	Y11002	Y11102
Y3	Y10003	Y10103	Y10203	Y10303	Y10403	Y10503	Y10603	Y10703	Y11003	Y11103
Y4	Y10004	Y10104	Y10204	Y10304	Y10404	Y10504	Y10604	Y10704	Y11004	Y11104
Y5	Y10005	Y10105	Y10205	Y10305	Y10405	Y10505	Y10605	Y10705	Y11005	Y11105
Y6	Y10006	Y10106	Y10206	Y10306	Y10406	Y10506	Y10606	Y10706	Y11006	Y11106
Y7	Y10007	Y10107	Y10207	Y10307	Y10407	Y10507	Y10607	Y10707	Y11007	Y11107
Y10	Y10010	Y10110	Y10210	Y10310	Y10410	Y10510	Y10610	Y10710	Y11010	Y11110
Y11	Y10011	Y10111	Y10211	Y10311	Y10411	Y10511	Y10611	Y10711	Y11011	Y11111
Y12	Y10012	Y10112	Y10212	Y10312	Y10412	Y10512	Y10612	Y10712	Y11012	Y11112
Y13	Y10013	Y10113	Y10213	Y10313	Y10413	Y10513	Y10613	Y10713	Y11013	Y11113
Y14	Y10014	Y10114	Y10214	Y10314	Y10414	Y10514	Y10614	Y10714	Y11014	Y11114
Y15	Y10015	Y10115	Y10215	Y10315	Y10415	Y10515	Y10615	Y10715	Y11015	Y11115
Y16	Y10016	Y10116	Y10216	Y10316	Y10416	Y10516	Y10616	Y10716	Y11016	Y11116
Y17	Y10017	Y10117	Y10217	Y10317	Y10417	Y10517	Y10617	Y10717	Y11017	X11117
Y20	Y10020	Y10120	Y10220	Y10320	Y10420	Y10520	Y10620	Y10720	Y11020	Y11120
Y21	Y10021	Y10121	Y10221	Y10321	Y10421	Y10521	Y10621	Y10721	Y11021	Y11121
Y22	Y10022	Y10122	Y10222	Y10322	Y10422	Y10522	Y10622	Y10722	Y11022	Y11122
Y23	Y10023	Y10123	Y10223	Y10323	Y10423	Y10523	Y10623	Y10723	Y11023	Y11123
Y24	Y10024	Y10124	Y10224	Y10324	Y10424	Y10524	Y10624	Y10724	Y11024	Y11124
Y25	Y10025	Y10125	Y10225	Y10325	Y10425	Y10525	Y10625	Y10725	Y11025	Y11125
Y26	Y10026	Y10126	Y10226	Y10326	Y10426	Y10526	Y10626	Y10726	Y11026	Y11126
Y27	Y10027	Y10127	Y10227	Y10327	Y10427	Y10527	Y10627	Y10727	Y11027	Y11127
Y30	Y10030	Y10130	Y10230	Y10330	Y10430	Y10530	Y10630	Y10730	Y11030	Y11130
Y31	Y10031	Y10131	Y10231	Y10331	Y10431	Y10531	Y10631	Y10731	Y11031	Y11131
Y32	Y10032	Y10132	Y10232	Y10332	Y10432	Y10532	Y10632	Y10732	Y11032	Y11132
Y33	Y10033	Y10133	Y10233	Y10333	Y10433	Y10533	Y10633	Y10733	Y11033	Y11133
Y34	Y10034	Y10134	Y10234	Y10334	Y10434	Y10534	Y10634	Y10734	Y11034	Y11134
Y35	Y10035	Y10135	Y10235	Y10335	Y10435	Y10535	Y10635	Y10735	Y11035	Y11135
Y36	Y10036	Y10136	Y10236	Y10336	Y10436	Y10536	Y10636	Y10736	Y11036	Y11136
Y37	Y10037	Y10137	Y10237	Y10337	Y10437	Y10537	Y10637	Y10737	Y11037	Y11137
	Expansion module no.11	Expansion module no.12	Expansion module no.13	Expansion module no.14	Expansion module no.15	Expansion module no.16				
Y0	Y11200	Y11300	Y11400	Y11500	Y11600	Y11700				

Y1	Y11201	Y11301	Y11401	Y11501	Y11601	Y11701				
Y2	Y11202	Y11302	Y11402	Y11502	Y11602	Y11702				
Y3	Y11203	Y11303	Y11403	Y11503	Y11603	Y11703				
Y4	Y11204	Y11304	Y11404	Y11504	Y11604	Y11704				
Y5	Y11205	Y11305	Y11405	Y11505	Y11605	Y11705				
Y6	Y11206	Y11306	Y11406	Y11506	Y11606	Y11706				
Y7	Y11207	Y11307	Y11407	Y11507	Y11607	Y11707				
Y10	Y11210	Y11310	Y11410	Y11510	Y11610	Y11710				
Y11	Y11211	Y11311	Y11411	Y11511	Y11611	Y11711				
Y12	Y11212	Y11312	Y11412	Y11512	Y11612	Y11712				
Y13	Y11213	Y11313	Y11413	Y11513	Y11613	Y11713				
Y14	Y11214	Y11314	Y11414	Y11514	Y11614	Y11714				
Y15	Y11215	Y11315	Y11415	Y11515	Y11615	Y11715				
Y16	Y11216	Y11316	Y11416	Y11516	Y11616	Y11716				
Y17	X11217	X11317	X11417	X11517	X11617	X11717				
Y20	Y11220	Y11320	Y11420	Y11520	Y11620	Y11720				
Y21	Y11221	Y11321	Y11421	Y11521	Y11621	Y11721				
Y22	Y11222	Y11322	Y11422	Y11522	Y11622	Y11722				
Y23	Y11223	Y11323	Y11423	Y11523	Y11623	Y11723				
Y24	Y11224	Y11324	Y11424	Y11524	Y11624	Y11724				
Y25	Y11225	Y11325	Y11425	Y11525	Y11625	Y11725				
Y26	Y11226	Y11326	Y11426	Y11526	Y11626	Y11726				
Y27	Y11227	Y11327	Y11427	Y11527	Y11627	Y11727				
Y30	Y11230	Y11330	Y11430	Y11530	Y11630	Y11730				
Y31	Y11231	Y11331	Y11431	Y11531	Y11631	Y11731				
Y32	Y11232	Y11332	Y11432	Y11532	Y11632	Y11732				
Y33	Y11233	Y11333	Y11433	Y11533	Y11633	Y11733				
Y34	Y11234	Y11334	Y11434	Y11534	Y11634	Y11734				
Y35	Y11235	Y11335	Y11435	Y11535	Y11635	Y11735				
Y36	Y11236	Y11336	Y11436	Y11536	Y11636	Y11736				
Y37	Y11237	Y11337	Y11437	Y11537	Y11637	Y11737				

- **XD-E32X**

Expansion module no.1 to no.16 input terminal address:

	Expansion module no.1	Expansion module no.2	Expansion module no.3	Expansion module no.4	Expansion module no.5	Expansion module no.6	Expansion module no.7	Expansion module no.8	Expansion module no.9	Expansion module no.10
X0	X10000	X10100	X10200	X10300	X10400	X10500	X10600	X10700	X11000	X11100
X1	X10001	X10101	X10201	X10301	X10401	X10501	X10601	X10701	X11001	X11101

X2	X10002	X10102	X10202	X10302	X10402	X10502	X10602	X10702	X11002	X11102
X3	X10003	X10103	X10203	X10303	X10403	X10503	X10603	X10703	X11003	X11103
X4	X10004	X10104	X10204	X10304	X10404	X10504	X10604	X10704	X11004	X11104
X5	X10005	X10105	X10205	X10305	X10405	X10505	X10605	X10705	X11005	X11105
X6	X10006	X10106	X10206	X10306	X10406	X10506	X10606	X10706	X11006	X11106
X7	X10007	X10107	X10207	X10307	X10407	X10507	X10607	X10707	X11007	X11107
X10	X10010	X10110	X10210	X10310	X10410	X10510	X10610	X10710	X11010	X11110
X11	X10011	X10111	X10211	X10311	X10411	X10511	X10611	X10711	X11011	X11111
X12	X10012	X10112	X10212	X10312	X10412	X10512	X10612	X10712	X11012	X11112
X13	X10013	X10113	X10213	X10313	X10413	X10513	X10613	X10713	X11013	X11113
X14	X10014	X10114	X10214	X10314	X10414	X10514	X10614	X10714	X11014	X11114
X15	X10015	X10115	X10215	X10315	X10415	X10515	X10615	X10715	X11015	X11115
X16	X10016	X10116	X10216	X10316	X10416	X10516	X10616	X10716	X11016	X11116
X17	X10017	X10117	X10217	X10317	X10417	X10517	X10617	X10717	X11017	X11117
X20	X10020	X10120	X10220	X10320	X10420	X10520	X10620	X10720	X11020	X11120
X21	X10021	X10121	X10221	X10321	X10421	X10521	X10621	X10721	X11021	X11121
X22	X10022	X10122	X10222	X10322	X10422	X10522	X10622	X10722	X11022	X11122
X23	X10023	X10123	X10223	X10323	X10423	X10523	X10623	X10723	X11023	X11123
X24	X10024	X10124	X10224	X10324	X10424	X10524	X10624	X10724	X11024	X11124
X25	X10025	X10125	X10225	X10325	X10425	X10525	X10625	X10725	X11025	X11125
X26	X10026	X10126	X10226	X10326	X10426	X10526	X10626	X10726	X11026	X11126
X27	X10027	X10127	X10227	X10327	X10427	X10527	X10627	X10727	X11027	X11127
X30	X10030	X10130	X10230	X10330	X10430	X10530	X10630	X10730	X11030	X11130
X31	X10031	X10131	X10231	X10331	X10431	X10531	X10631	X10731	X11031	X11131
X32	X10032	X10132	X10232	X10332	X10432	X10532	X10632	X10732	X11032	X11132
X33	X10033	X10133	X10233	X10333	X10433	X10533	X10633	X10733	X11033	X11133
X34	X10034	X10134	X10234	X10334	X10434	X10534	X10634	X10734	X11034	X11134
X35	X10035	X10135	X10235	X10335	X10435	X10535	X10635	X10735	X11035	X11135
X36	X10036	X10136	X10236	X10336	X10436	X10536	X10636	X10736	X11036	X11136
X37	X10037	X10137	X10237	X10337	X10437	X10537	X10637	X10737	X11037	X11137
	Expansion module no.11	Expansion module no.12	Expansion module no.13	Expansion module no.14	Expansion module no.15	Expansion module no.16				
X0	X11200	X11300	X11400	X11500	X11600	X11700				
X1	X11201	X11301	X11401	X11501	X11601	X11701				
X2	X11202	X11302	X11402	X11502	X11602	X11702				
X3	X11203	X11303	X11403	X11503	X11603	X11703				
X4	X11204	X11304	X11404	X11504	X11604	X11704				
X5	X11205	X11305	X11405	X11505	X11605	X11705				
X6	X11206	X11306	X11406	X11506	X11606	X11706				
X7	X11207	X11307	X11407	X11507	X11607	X11707				
X10	X11210	X11310	X11410	X11510	X11610	X11710				

X11	X11211	X11311	X11411	X11511	X11611	X11711				
X12	X11212	X11312	X11412	X11512	X11612	X11712				
X13	X11213	X11313	X11413	X11513	X11613	X11713				
X14	X11214	X11314	X11414	X11514	X11614	X11714				
X15	X11215	X11315	X11415	X11515	X11615	X11715				
X16	X11216	X11316	X11416	X11516	X11616	X11716				
X17	X11217	X11317	X11417	X11517	X11617	X11717				
X20	X11220	X11320	X11420	X11520	X11620	X11720				
X21	X11221	X11321	X11421	X11521	X11621	X11721				
X22	X11222	X11322	X11422	X11522	X11622	X11722				
X23	X11223	X11323	X11423	X11523	X11623	X11723				
X24	X11224	X11324	X11424	X11524	X11624	X11724				
X25	X11225	X11325	X11425	X11525	X11625	X11725				
X26	X11226	X11326	X11426	X11526	X11626	X11726				
X27	X11227	X11327	X11427	X11527	X11627	X11727				
X30	X11230	X11330	X11430	X11530	X11630	X11730				
X31	X11231	X11331	X11431	X11531	X11631	X11731				
X32	X11232	X11332	X11432	X11532	X11632	X11732				
X33	X11233	X11333	X11433	X11533	X11633	X11733				
X34	X11234	X11334	X11434	X11534	X11634	X11734				
X35	X11235	X11335	X11435	X11535	X11635	X11735				
X36	X11236	X11336	X11436	X11536	X11636	X11736				
X37	X11237	X11337	X11437	X11537	X11637	X11737				

2-4. External connection

(1) The input terminal connection diagram:

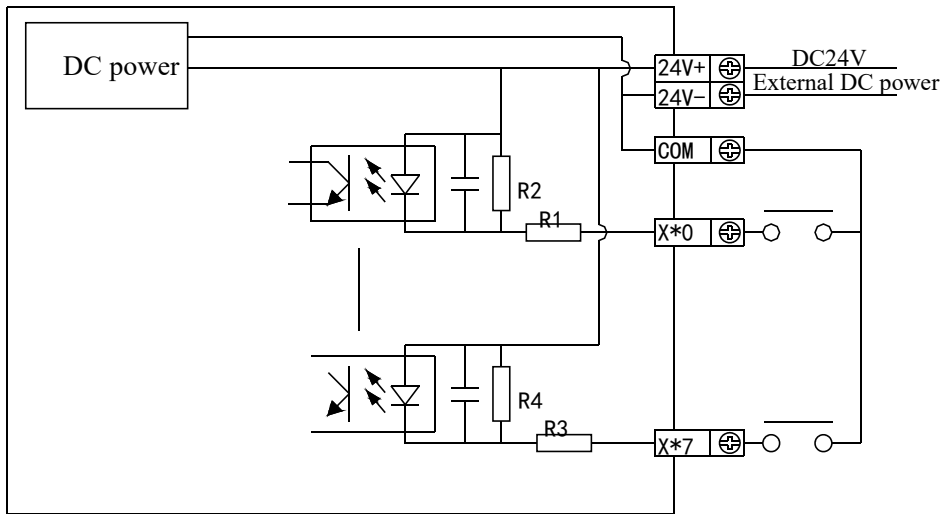

NPN type

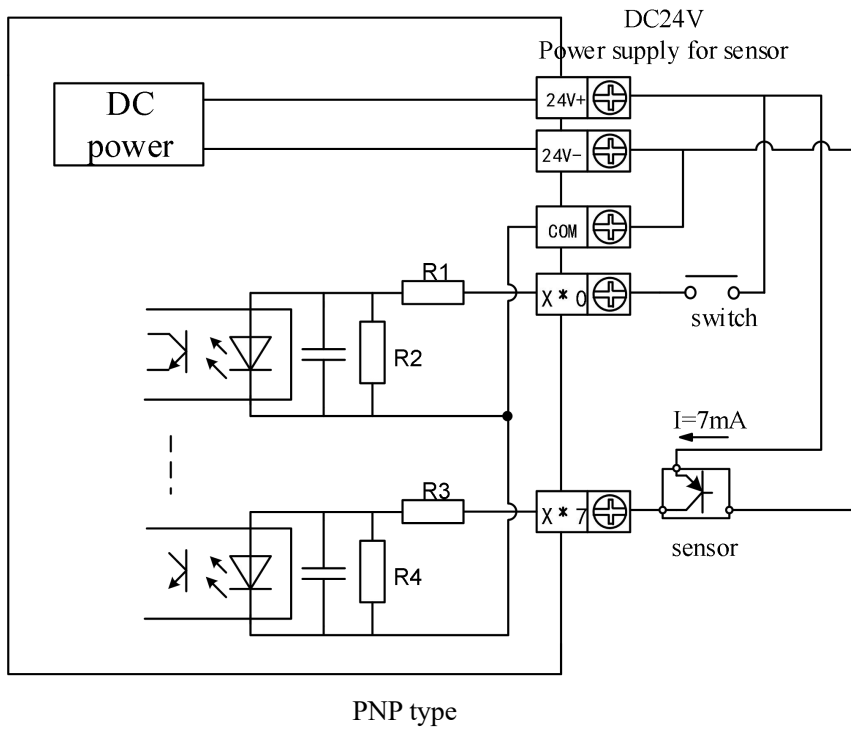

(2) The output terminal connection diagram:

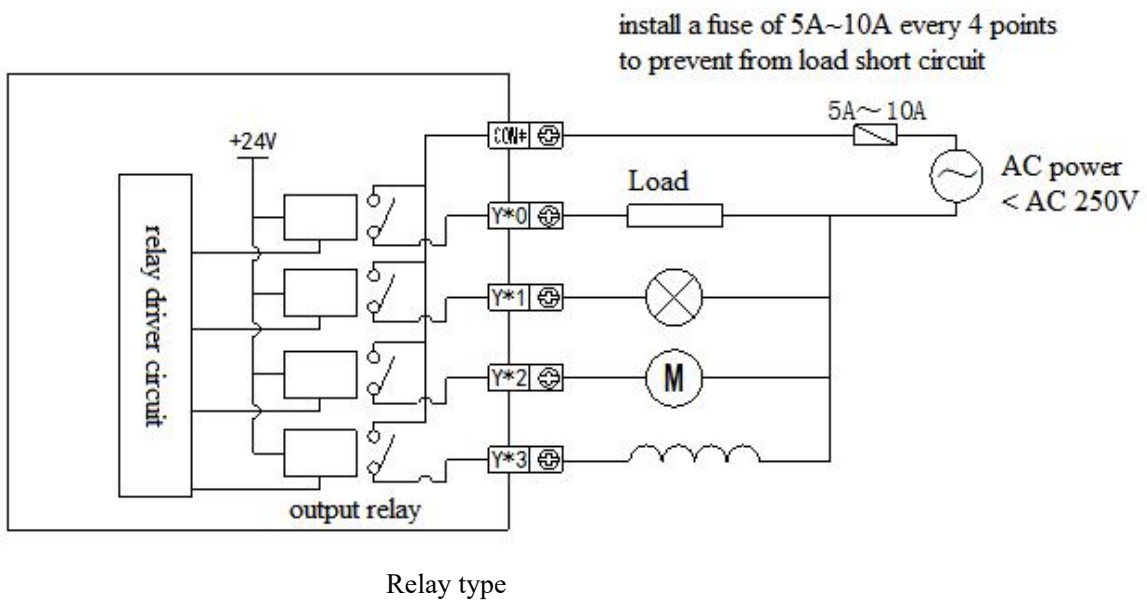

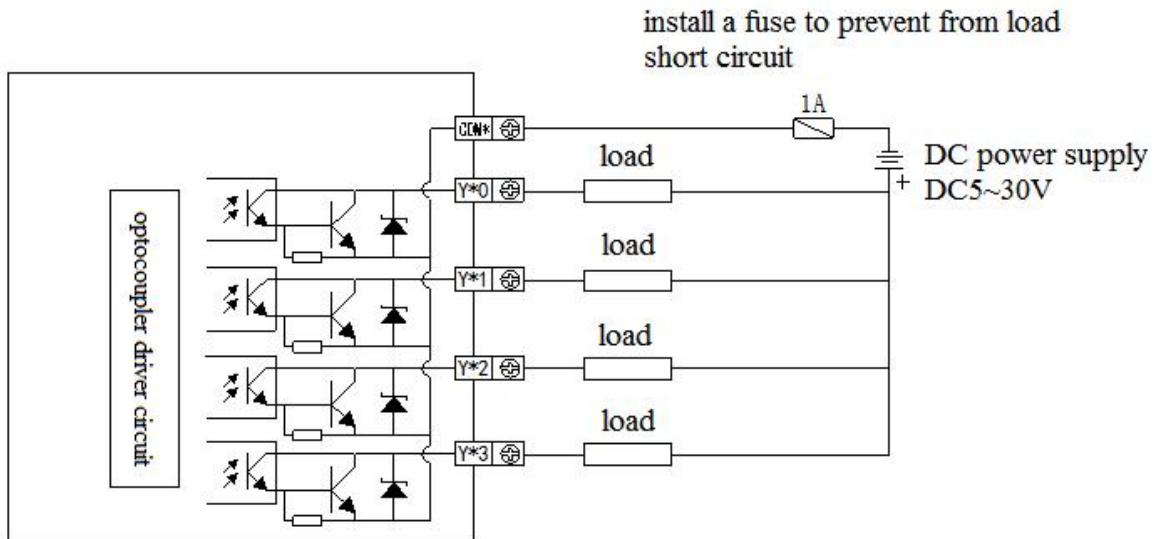

Transistor type

2-5. Module parameters

There are two parameters for the module: positive or negative logic, filter time.

There are two setting methods:

(1) XDPpro software

Open the XDPpro software, click configure/expansion module settings:

Set the model and channel parameters in the following window. Then click write to PLC.

Please restart the PLC after setting.

Note: please select XD/E-8X8Y for configuring XD-E8X, XD-E8YR, XD-E8YT.

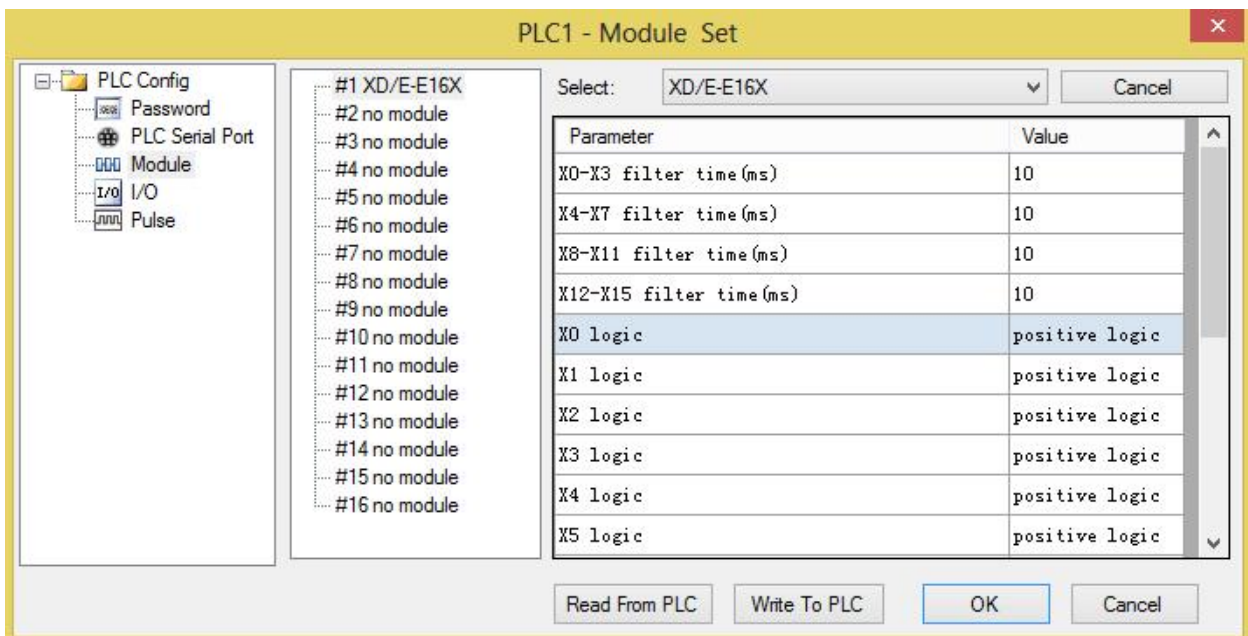

(2) Set through SFD register

Module no.	SFD address	Module no.	SFD address
#1	SFD350~SFD359	#9	SFD430~SFD439
#2	SFD360~SFD369	#10	SFD440~SFD449
#3	SFD370~SFD379	#11	SFD450~SFD459
#4	SFD380~SFD389	#12	SFD460~SFD469
#5	SFD390~SFD399	#13	SFD470~SFD479
#6	SFD400~SFD409	#14	SFD480~SFD489
#7	SFD410~SFD419	#15	SFD490~SFD499
#8	SFD420~SFD429	#16	SFD500~SFD509

The first 20 bytes definitions:

■ **XD-E8X8YR, XD-E8X8YT**

	Byte0	Byte1	Byte2	Byte3	Byte4	Byte5	Byte6~ Byte19
Bit7	X0~X3 filter time	X4~X7 filter time	-	-	-	-	-
Bit6			X3 logic	X7 logic	Y3 logic	Y7 logic	-
Bit5			-	-	-	-	-
Bit4			X2 logic	X6 logic	Y2 logic	Y6 logic	-
Bit3			-	-	-	-	-
Bit2			X1 logic	X5 logic	Y1 logic	Y5 logic	-
Bit1			-	-	-	-	-
Bit0			X0 logic	X4 logic	Y0 logic	Y4 logic	-
note	filter time (ms) setting range: 1~5, 10, 15, 20, 25, 30, 35, 40, 45, 50. Default value is 10ms.		0 is positive logic 1 is negative logic				-

■ XD-E8YR, XD-E8YT

	Byte0	Byte1	Byte2	Byte3	Byte4	Byte5	Byte6~Byte19
Bit7	-	-	-	-	-	-	-
Bit6			-	-	Y3 logic	Y7 logic	-
Bit5			-	-	-	-	-
Bit4			-	-	Y2 logic	Y6 logic	-
Bit3			-	-	-	-	-
Bit2			-	-	Y1 logic	Y5 logic	-
Bit1			-	-	-	-	-
Bit0			-	-	Y0 logic	Y4 logic	-
note	filter time (ms) setting range: 1~5, 10, 15, 20, 25, 30, 35, 40, 45, 50. Default value is 10ms.		0 is positive logic 1 is negative logic			-	

■ XD-E8X

	Byte0	Byte1	Byte2	Byte3	Byte4	Byte5	Byte6~Byte19
Bit7	X0~X3 filter time	X4~X7 filter time	-	-	-	-	-
Bit6			X3 logic	X7 logic	-	-	-
Bit5			-	-	-	-	-
Bit4			X2 logic	X6 logic	-	-	-
Bit3			-	-	-	-	-
Bit2			X1 logic	X5 logic	-	-	-
Bit1			-	-	-	-	-
Bit0			X0 logic	X4 logic	-	-	-
note	filter time (ms) setting range: 1~5, 10, 15, 20, 25, 30, 35, 40, 45, 50. Default value is 10ms.		0 is positive logic 1 is negative logic			-	

■ XD-E16X

	Byte0	Byte1	Byte2	Byte3	Byte 4	Byte 5	Byte 6	Byte 7	Byte8~Byte19
Bit7	X0~X3 filter time	X4~X7 filter time	X10~X13 filter time	X14~X17 Filter time	-	-	-	-	-
Bit6					X3 logic	X7 logic	X13 logic	X17 logic	-
Bit5					-	-	-	-	-
Bit4					X2 logic	X6 logic	X12 logic	X16 logic	-
Bit3					-	-	-	-	-

Bit2					X1 logic	X5 logic	X11 logic	X15 logic	-
Bit1					-	-	-	-	-
Bit0					X0 logic	X4 logic	X10 logic	X14 logic	-
note	filter time (ms) setting range: 1~5, 10, 15, 20, 25, 30, 35, 40, 45, 50. Default value is 10ms.				0 is positive logic 1 is negative logic				-

■ **XD-E16X16Y**

	Bit0	Bit1	Bit2	Bit3	Bit4	Bit5	Bit6	Bit7	Notes
Byte0	X0~X3 filter time								filter time (ms) setting range: 1~5, 10, 15, 20, 25, 30, 35, 40, 45, 50. Default value is 10ms.
Byte1	X4~X7 filter time								
Byte2	X10~X13 filter time								
Byte3	X14~X17 filter time								
Byte4	X0 logic	-	X1 logic	-	X2 logic	-	X3 logic	-	0 is positive logic 1 is negative logic
Byte5	X4 logic	-	X5 logic	-	X6 logic	-	X7 logic	-	
Byte6	X10 logic	-	X11 logic	-	X12 logic	-	X13 logic	-	
Byte7	X14 logic	-	X15 logic	-	X16 logic	-	X17 logic	-	
Byte8	Y0 logic	-	Y1 logic	-	Y2 logic	-	Y3 logic	-	
Byte9	Y4 logic	-	Y5 logic	-	Y6 logic	-	Y7 logic	-	
Byte10	Y10 logic	-	Y11 logic	-	Y12 logic	-	Y13 logic	-	
Byte11	Y14 logic	-	Y15 logic	-	Y16 logic	-	Y17 logic	-	
Byte 12~19	-	-	-	-	-	-	-	-	

■ **XD-E16Y/XD-E32Y**

	Bit0	Bit1	Bit2	Bit3	Bit4	Bit5	Bit6	Bit7	Notes
Byte0	Y0 logic	-	Y1 logic	-	Y2 logic	-	Y3 logic	-	0 is positive logic 1 is negative logic
Byte1	Y4 logic	-	Y5 logic	-	Y6 logic	-	Y7 logic	-	
Byte2	Y10 logic	-	Y11 logic	-	Y12 logic	-	Y13 logic	-	
Byte3	Y14 logic	-	Y15 logic	-	Y16 logic	-	Y17 logic	-	
Byte4	Y20 logic	-	Y21 logic	-	Y22 logic	-	Y23 logic	-	
Byte5	Y24 logic	-	Y25 logic	-	Y26 logic	-	Y27 logic	-	

Byte6	Y30 logic	-	Y31 logic	-	Y32 logic	-	Y33 logic	-	
Byte7	Y34 logic	-	Y35 logic	-	Y36 logic	-	Y37 logic	-	
Byte8~19	-	-	-	-	-	-	-	-	

■ **XD-E32X**

	Bit0	Bit1	Bit2	Bit3	Bit4	Bit5	Bit6	Bit7	Notes
Byte0	X0~X3 filter time								filter time (ms) setting range: 1~5, 10, 15, 20, 25, 30, 35, 40, 45, 50. Default value is 10ms.
Byte1	X4~X7 filter time								
Byte2	X10~X13 filter time								
Byte3	X14~X17 filter time								
Byte4	X20~X23 filter time								
Byte5	X24~X27 filter time								
Byte6	X30~X33 filter time								
Byte7	X34~X37 filter time								
Byte8	X0 logic	-	X1 logic	-	X2 logic	-	X3 logic	-	0 is positive logic 1 is negative logic
Byte9	X4 logic	-	X5 logic	-	X6 logic	-	X7 logic	-	
Byte10	X10 logic	-	X11 logic	-	X12 logic	-	X13 logic	-	
Byte11	X14 logic	-	X15 logic	-	X16 logic	-	X17 logic	-	
Byte12	X20 logic	-	X21 logic	-	X22 logic	-	X23 logic	-	
Byte13	X24 logic	-	X25 logic	-	X26 logic	-	X27 logic	-	
Byte14	X30 logic	-	X31 logic	-	X32 logic	-	X33 logic	-	
Byte15	X34 logic	-	X35 logic	-	X36 logic	-	X37 logic	-	
Byte 16~19	-	-	-	-	-	-	-	-	

Note:

1. User can set the discrete input filter time, the time can be 1, 2, 3, 4, 5, 10, 15, 20, 25, 30, 35, 40, 45, 50.
The default filter time is 10ms.
2. User can set the discrete input and output polarity: 0 is positive logic; 1 is negative logic.
3. Positive logic: the input point is on when there is a signal, and off when there is no signal;
Negative logic: the input point is on when there is no signal, and off when there is signal.

2-6. Applications

The application example includes three devices: Xinje XD3 series PLC (slave station), expansion module XD-E8X8YR and HMI TH765-NT.

The communication between XD-E8X8YR and TH765-NT:

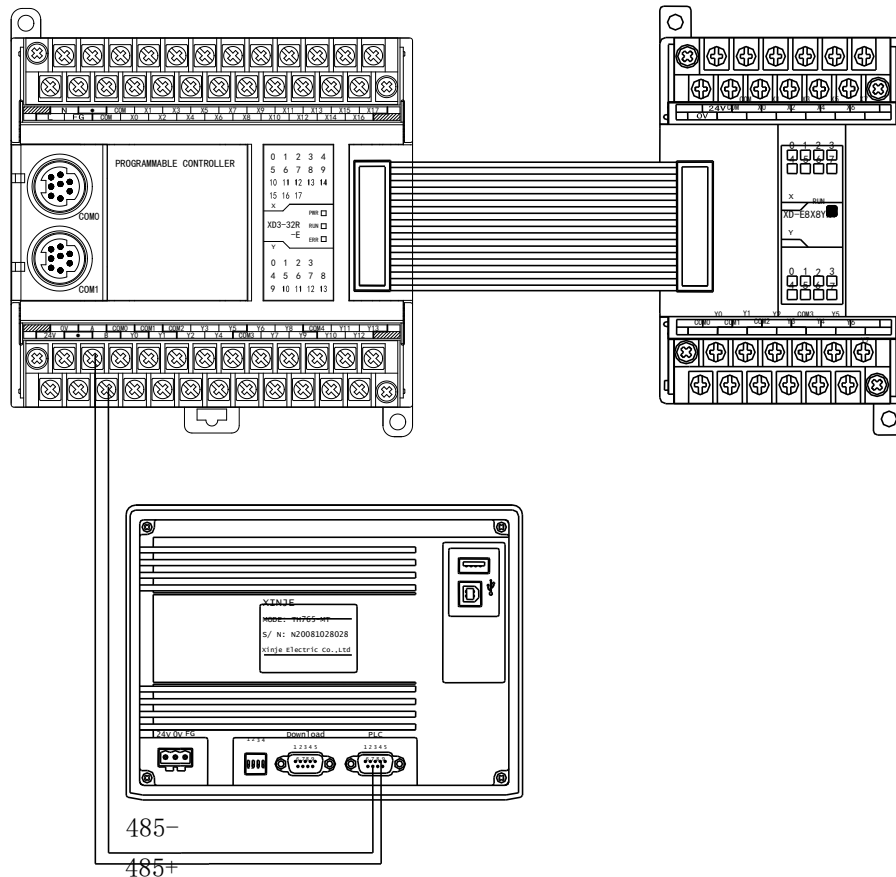

In this example, the HMI is the master station, read the input status of extension module to the HMI, writes the coil status of HMI to the extension module.

(1) Hardware connection: Connect XD-E8X8YR with XD3-32R-E, connect AB terminals of XD3-32R-E to AB terminals (PLC port) of TH765-NT.

Communication parameters setting of PLC:

Baud rate: 19200bps, Data bits: 8bits, Stop bits: 1bit, Parity: even, Modbus number: 1, restart the PLC after setting.

Touchwin software settings for TH765-NT:

PLC port device: "Modbus RTU (Panel is master)", Baud rate: 19200bps, Data bits: 8bits, Stop bits: 1bit, Parity: even.

(2) Program application:

The corresponding relationship between expansion module address and HMI address:

HMI address	Expansion module	Related MODBUS address
PSB500	X10000	K20736
PSB501	Y10000	K24832

(3) HMI screen editing:
The screen of HMI:

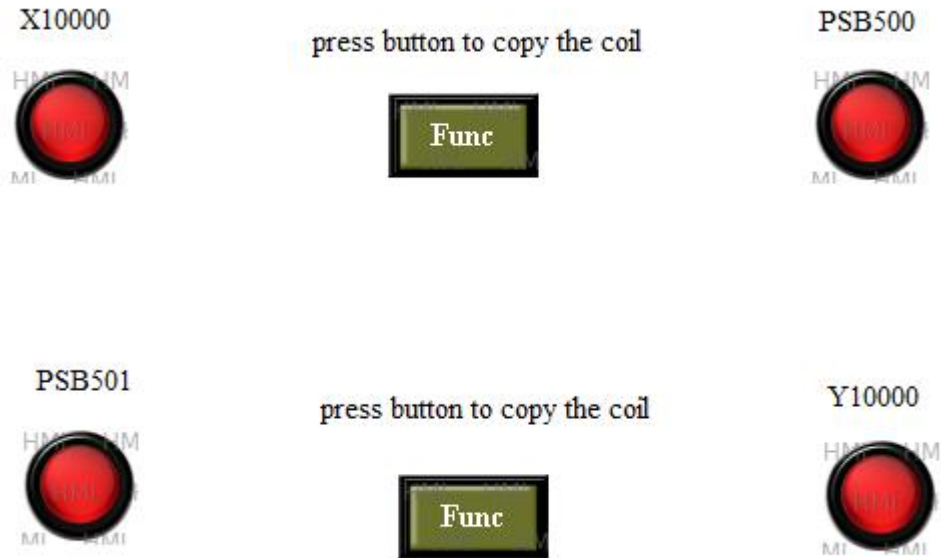

Edit the status of X10000:

Lamp X10000: the Modbus address of expansion module coil X10000 is 0x20736 (diagram A).

Function Button: copy the coil status of X10000 to PSB500 when the button is pressed (diagram B).

Lamp PSB500: HMI internal coil address is PSB500. (diagram C)

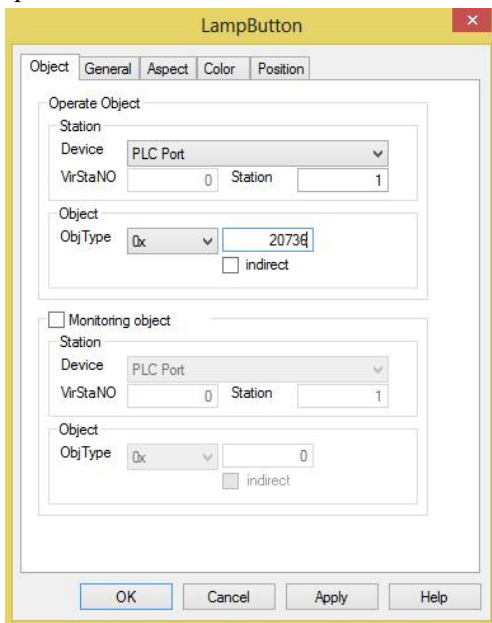

Diagram A

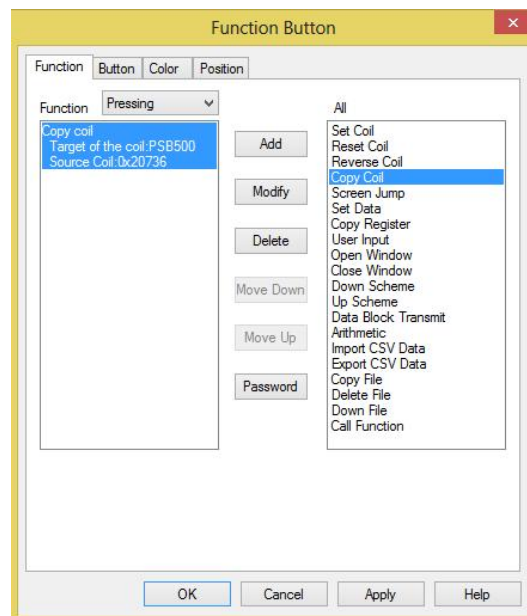

Diagram B

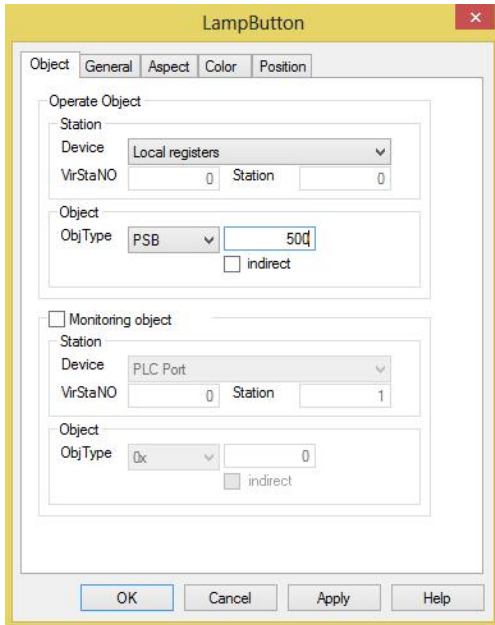

Diagram C

Edit the status of PSB501:

Lamp PSB501: the HMI internal coil address is PSB501 (diagram D);

Function Button: copy the coil status of PSB501 to Y10000 when the button is pressed (diagram E);

Lamp Y10000: the Modbus address of expansion module coil Y10000 is 0x24832 (diagram F).

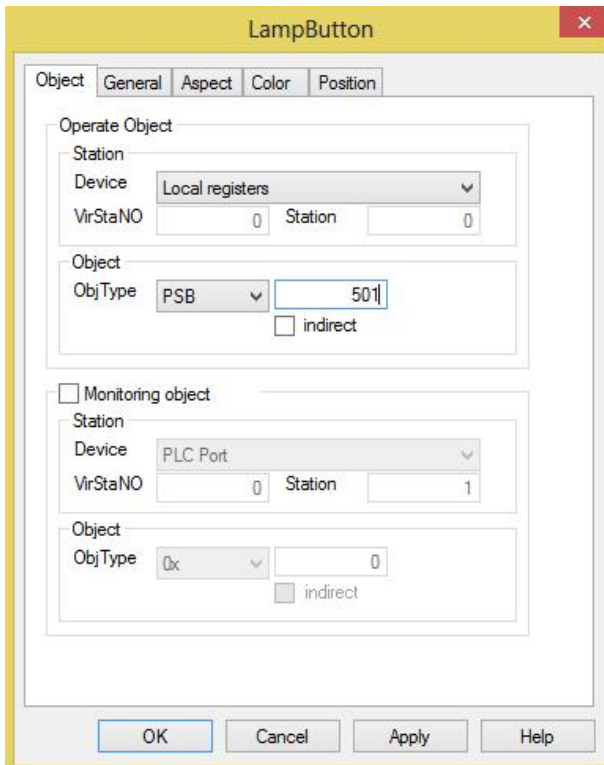

Diagram D

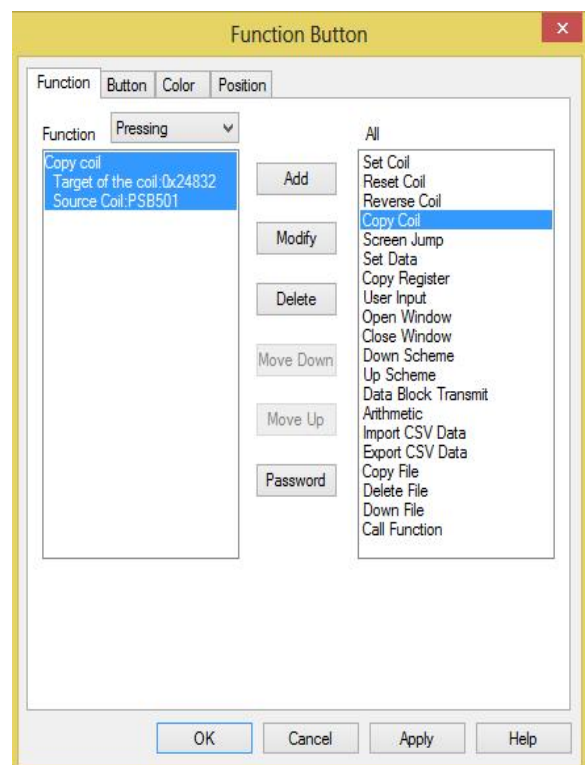

Diagram E

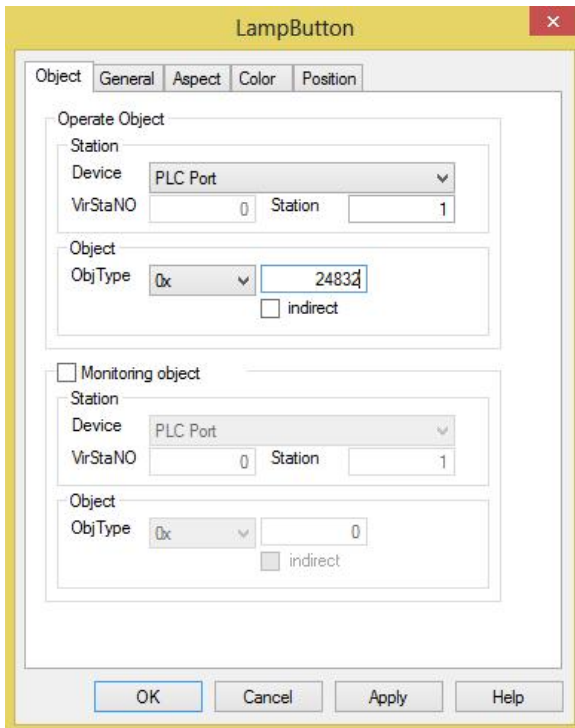

Diagram F

After editing the HMI screen, download it to the HMI and start to work.

3. Analog input/output module XD-E4AD2DA

3-1. Specification

XD-E4AD2DA transform the 4 channels analog value to digital value, 2 channels digital value to analog value, and send them to PLC.

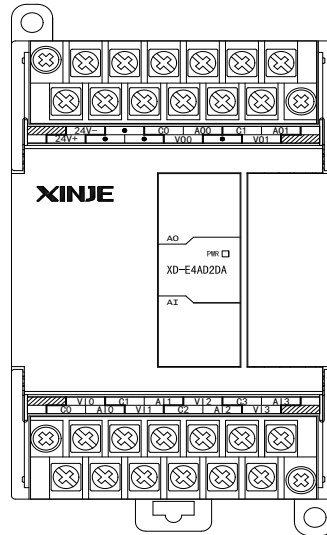

Features:

- 4-channel analog input: voltage input and current input can be selected
- 2 channel analog output
- 14-bit high precision analog input
- As the special function module of XD3/XD3E, 10 modules can be connected to the PLC. XD5/XDM/XDC/XD5E/XDME/XDH can extend 16 modules. XD1/XD2 cannot extend modules.

Module specifications:

Items	Analog input (AD)		Analog output (DA)	
	Voltage input	Current input	Voltage output	Current output
Analog input bound	0~5V, 0~10V, -5~5V, -10~10V (impedance>1M)	0~20mA, 4~20mA, -20~20mA (impedance is about 120 Ω)	-	-
Max input bound	DC ±15V	-40~40mA	-	-
Analog output bound	-	-	0~5V, 0~10V, -5~5V, -10~10V (Exterior load resistance 2KΩ~1MΩ)	0~20mA, 4~20mA (Exterior load resistance is less than 500Ω)
Digital input bound	-	-	12 bits binary data (0~4095 or -2048~2047)	

Digital output bound	14 bits binary data (0~16383 or -8192~8191)	-
Distinguish ratio	1/16383(14Bit)	1/4095(12Bit)
Integrate precision	±1%	
Convert speed	2ms per channel	2ms per channel
Power used by analog	DC24V±10%,150mA	
Install format	Fixed with M3 screws or directly installed on orbit of DIN46277 (Width: 35mm)	
Exterior size	63mm×108mm×89.9mm	

Note: XD-E4AD2DA module of V6 and below version cannot support the range of -5~5V, -10~10V, -20~20mA.

3-2. Terminals

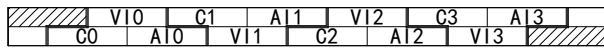
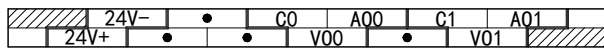

Channel	Terminal name	Signal name
CH0	AI0	Current input
	VI0	Voltage input
	C0	CH0 common terminal of analog input
CH1	AI1	Current input
	VI1	Voltage input
	C1	CH1 common terminal of analog input
CH2	AI2	Current input
	VI2	Voltage input
	C2	CH2 common terminal of analog input
CH3	AI3	Current input
	VI3	Voltage input
	C3	CH3 common terminal of analog input
CH0	AO0	Current output
	VO0	Voltage output
	C0	CH0 common terminal of analog output
CH1	AO1	Current output
	VO1	Voltage output
	C1	CH1 common terminal of analog output
-	24V+	+24V power supply
	24V-	Common terminal of power supply

3-3. The assignment of I/O address

XD series analog modules do not occupy I/O units; the converted data is directly transferred into PLC register,

Register address of module1:

Channel	AD signal	Channel enable bit (set ON the bit to use this channel)	Channel alarm flag bit
0CH	ID10000	Y10000	X10000
1CH	ID10001	Y10001	X10001
2CH	ID10002	Y10002	X10002
3CH	ID10003	Y10003	X10003
Channel	DA signal		
0CH	QD10000	Y10004	
1CH	QD10001	Y10005	

Register address of module2:

Channel	AD signal	Channel enable bit (set ON the bit to use this channel)	Channel alarm flag bit
0CH	ID10100	Y10100	X10100
1CH	ID10101	Y10101	X10101
2CH	ID10102	Y10102	X10102
3CH	ID10103	Y10103	X10103
Channel	DA signal		
0CH	QD10100	Y10104	
1CH	QD10101	Y10105	

Register address of module3:

Channel	AD signal	Channel enable bit (set ON the bit to use this channel)	Channel alarm flag bit
0CH	ID10200	Y10200	X10200
1CH	ID10201	Y10201	X10201
2CH	ID10202	Y10202	X10202
3CH	ID10203	Y10203	X10203
Channel	DA signal		
0CH	QD10200	Y10204	
1CH	QD10201	Y10205	

Register address of module4:

Channel	AD signal	Channel enable bit (set ON the bit to use this channel)	Channel alarm flag bit
0CH	ID10300	Y10300	X10300
1CH	ID10301	Y10301	X10301
2CH	ID10302	Y10302	X10302
3CH	ID10303	Y10303	X10303
Channel	DA signal		
0CH	QD10300	Y10304	
1CH	QD10301	Y10305	

Register address of module5:

Channel	AD signal	Channel enable bit (set ON the bit to use this channel)	Channel alarm flag bit
0CH	ID10400	Y10400	X10400
1CH	ID10401	Y10401	X10401
2CH	ID10402	Y10402	X10402
3CH	ID10403	Y10403	X10403
Channel	DA signal		
0CH	QD10400	Y10404	
1CH	QD10401	Y10405	

Register address of module6:

Channel	AD signal	Channel enable bit (set ON the bit to use this channel)	Channel alarm flag bit
0CH	ID10500	Y10500	X10500
1CH	ID10501	Y10501	X10501
2CH	ID10502	Y10502	X10502
3CH	ID10503	Y10503	X10503
Channel	DA signal		
0CH	QD10500	Y10504	
1CH	QD10501	Y10505	

Register address of module7:

Channel	AD signal	Channel enable bit (set ON the bit to use this channel)	Channel alarm flag bit
0CH	ID10600	Y10600	X10600
1CH	ID10601	Y10601	X10601
2CH	ID10602	Y10602	X10602
3CH	ID10603	Y10603	X10603
Channel	DA signal		
0CH	QD10600	Y10604	
1CH	QD10601	Y10605	

Register address of module8:

Channel	AD signal	Channel enable bit (set ON the bit to use this channel)	Channel alarm flag bit
0CH	ID10700	Y10700	X10700
1CH	ID10701	Y10701	X10701
2CH	ID10702	Y10702	X10702
3CH	ID10703	Y10703	X10703
Channel	DA signal		
0CH	QD10700	Y10704	
1CH	QD10701	Y10705	

Register address of module9:

Channel	AD signal	Channel enable bit (set ON the bit to use this channel)	Channel alarm flag bit
0CH	ID10800	Y11000	X11000
1CH	ID10801	Y11001	X11001
2CH	ID10802	Y11002	X11002
3CH	ID10803	Y11003	X11003
Channel	DA signal		
0CH	QD10800	Y11004	
1CH	QD10801	Y11005	

Register address of module10:

Channel	AD signal	Channel enable bit (set ON the bit to use this channel)	Channel alarm flag bit
0CH	ID10900	Y11100	X11100
1CH	ID10901	Y11101	X11101
2CH	ID10902	Y11102	X11102
3CH	ID10903	Y11103	X11103
Channel	DA signal		
0CH	QD10900	Y11104	
1CH	QD10901	Y11105	

Register address of module11:

Channel	AD signal	Channel enable bit (set ON the bit to use this channel)	Channel alarm flag bit
0CH	ID11000	Y11200	X11200
1CH	ID11001	Y11201	X11201
2CH	ID11002	Y11202	X11202
3CH	ID11003	Y11203	X11203
Channel	DA signal		
0CH	QD11000	Y11204	
1CH	QD11001	Y11205	

Register address of module12:

Channel	AD signal	Channel enable bit (set ON the bit to use this channel)	Channel alarm flag bit
0CH	ID11100	Y11300	X11300
1CH	ID11101	Y11301	X11301
2CH	ID11102	Y11302	X11302
3CH	ID11103	Y11303	X11303
Channel	DA signal		
0CH	QD11100	Y11304	
1CH	QD11101	Y11305	

Register address of module13:

Channel	AD signal	Channel enable bit (set ON the bit to use this channel)	Channel alarm flag bit
0CH	ID11200	Y11400	X11400
1CH	ID11201	Y11401	X11401
2CH	ID11202	Y11402	X11402
3CH	ID11203	Y11403	X11403
Channel	DA signal		
0CH	QD11200	Y11404	
1CH	QD11201	Y11405	

Register address of module14:

Channel	AD signal	Channel enable bit (set ON the bit to use this channel)	Channel alarm flag bit
0CH	ID11300	Y11500	X11500
1CH	ID11301	Y11501	X11501
2CH	ID11302	Y11502	X11502
3CH	ID11303	Y11503	X11503
Channel	DA signal		
0CH	QD11300	Y11504	
1CH	QD11301	Y11505	

Register address of module15:

Channel	AD signal	Channel enable bit (set ON the bit to use this channel)	Channel alarm flag bit
0CH	ID11400	Y11600	X11600
1CH	ID11401	Y11601	X11601
2CH	ID11402	Y11602	X11602
3CH	ID11403	Y11603	X11603
Channel	DA signal		
0CH	QD11400	Y11604	
1CH	QD11401	Y11605	

Register address of module16:

Channel	AD signal	Channel enable bit (set ON the bit to use this channel)	Channel alarm flag bit
0CH	ID11500	Y11700	X11700
1CH	ID11501	Y11701	X11701
2CH	ID11502	Y11702	X11702
3CH	ID11503	Y11703	X11703
Channel	DA signal		
0CH	QD11500	Y11704	
1CH	QD11501	Y11705	

Note:

1. Disable the unused channel to improve the I/O scanning speed.
2. If set off the enable bit of the input channel, this channel will not accept the data. (the data display is 0).
3. If set off the enable bit of the output channel, this channel will keep the former data.

3-4. Working mode

There are two ways to set the working mode:

1. XDPpro software
2. Flash registers of PLC

XDPpro software:

Open the XDPpro software, click configure/expansion module settings.

Set the model and channel parameters in the following window. Then click write to PLC.

Please restart the PLC after setting.

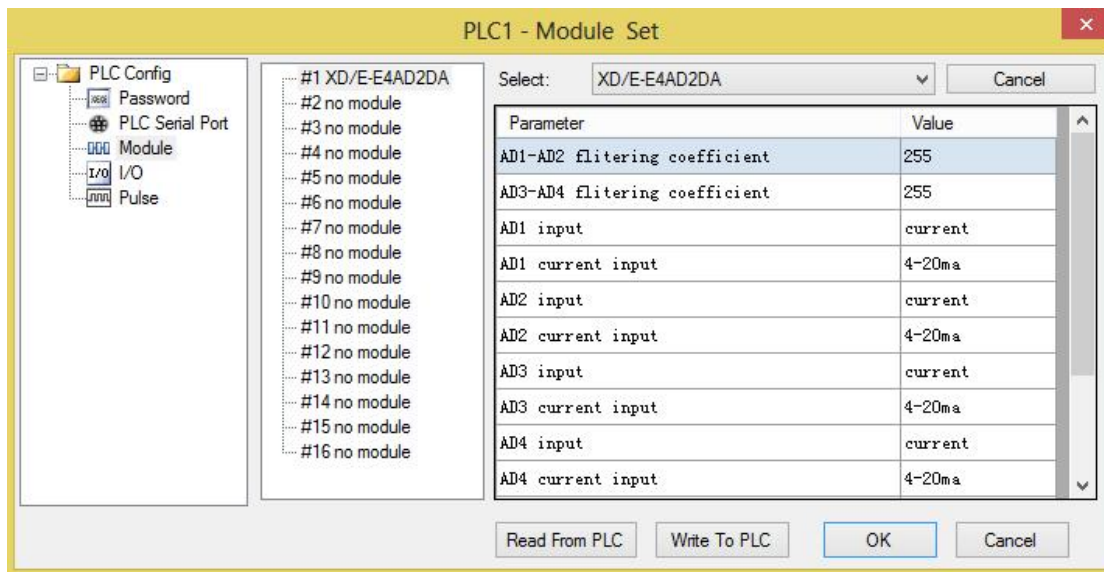

Note:

1. The first-order low-pass filtering method uses this sampling value and the last filtering output value for weighting to get the effective filtering value.
2. The filter coefficient is set to 0 ~ 254 by the user, the smaller the value is, the more stable the data is, but it may cause data lag; when it is set to 1, the filtering effect is the strongest, and when it is set to 254, the filtering effect is the weakest, and the default value is 0 (no filtering).

3. When the module flag bit `Short circuit / circuit breakage / supe... open` is set on, please monitor X but not Y, as Y is channel enable bit.

For example: When the first channel of AD is set to voltage mode and AD detects short circuit / open circuit / over range, X10000 will be set to on;

The first channel of AD is set to current mode. When AD is detected as over range, X10000 will be set to on.

Flash registers:

The module has current and voltage mode. Current has choices of 0~20mA, 4~20mA; voltage has choices of 0~5V, 0~10V. These parameters can be set through SFD registers.

Module no.	SFD address	Module no.	SFD address
#1	SFD350~SFD359	#9	SFD430~SFD439
#2	SFD360~SFD369	#10	SFD440~SFD449
#3	SFD370~SFD379	#11	SFD450~SFD459
#4	SFD380~SFD389	#12	SFD460~SFD469

#5	SFD390~SFD399	#13	SFD470~SFD479
#6	SFD400~SFD409	#14	SFD480~SFD489
#7	SFD410~SFD419	#15	SFD490~SFD499
#8	SFD420~SFD429	#16	SFD500~SFD509

Note: As shown in the preceding table, every register set 4 channels mode, each register has 16 bits, from low to high, every 4 bits set 1 channel mode.

SFD register bit definition:

Module no.1:

Register		Bit7	Bit6	Bit5	Bit4	Bit3	Bit2	Bit1	Bit0	Notes	
SFD350	Byte0	AD channel 1, 2 filtering coefficient								AD filtering coefficient	
	Byte1	AD channel 3, 4 filtering coefficient									
SFD351	Byte2	Bit7	Bit6	Bit5	Bit4	Bit3	Bit2	Bit1	Bit0	To set the input range of AD/DA module. Byte2 low 4-bit is to set AD Channel 1, high 4-bit is to set AD channel 2. Byte3 Low 4-bit is to set AD channel 3, high 4-bit is to set AD channel 4. Byte4	
		AD2				AD1					
	-	000: 0~10V 001: 0~5V 100: -10~10V 101: -5~5V 010: 0~20mA 011: 4~20mA 110: -20~20mA				-	000: 0~10V 001: 0~5V 100: -10~10V 101: -5~5V 010: 0~20mA 011: 4~20mA 110: -20~20mA				
	Bit7	Bit6	Bit5	Bit4	Bit3	Bit2	Bit1	Bit0			
SFD351	Byte3	AD4				AD3					
		-	000: 0~10V 001: 0~5V 100: -10~10V 101: -5~5V 010: 0~20mA 011: 4~20mA 110: -20~20mA				-	000: 0~10V 001: 0~5V 100: -10~10V 101: -5~5V 010: 0~20mA 011: 4~20mA 110: -20~20mA			
SFD352	Byte4	Bit7	Bit6	Bit5	Bit4	Bit3	Bit2	Bit1	Bit0	AD channel 4. Byte4	
		DA2				DA1					

		-	000: 0~10V 001: 0~5V 100: -10~10V 101: -5~5V 010: 0~20mA 011: 4~20mA 110: -20~20mA	-	000: 0~10V 001: 0~5V 100: -10~10V 101: -5~5V 010: 0~20mA 011: 4~20mA 110: -20~20mA	low 4-bit is to set DA channel 1, high 4-bit is to set DA Channel 2.
	Byte5	AD channel short circuit / open circuit / over range detection bit				
SFD353~SFD359	-					

For example:

Set the module no.1 AD channel 3, 2, 1, 0 working mode to 0~20mA, 4~20mA, 0~10V, 0~5V. Set the channel 1 and 2 filter factor to 254, set the channel 3 and 4 filter factor to 100. Set DA channel 1 and 0 working mode to 0~10V, 0~20mA.

So the SFD register values are:

SFD350=64FEH SFD351=4C1H SFD352=10H

3-5. Exterior connection

When make exterior connection, please read the following items:

- When connect +24V power, please choose 24V power of PLC to avoid interference.
- To avoid interference, please use shield cable and single point ground for the shield layer.

Voltage input

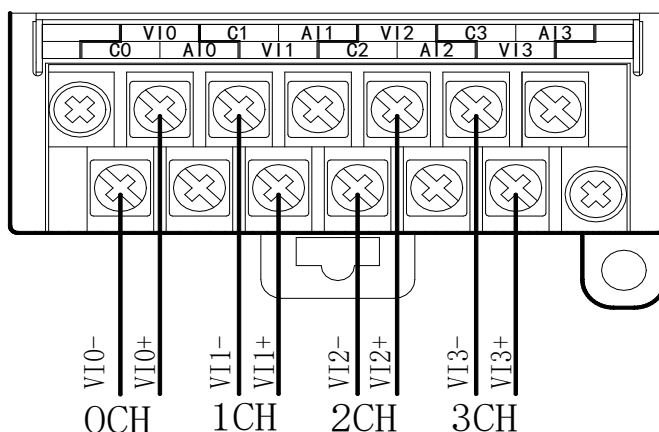

Voltage output

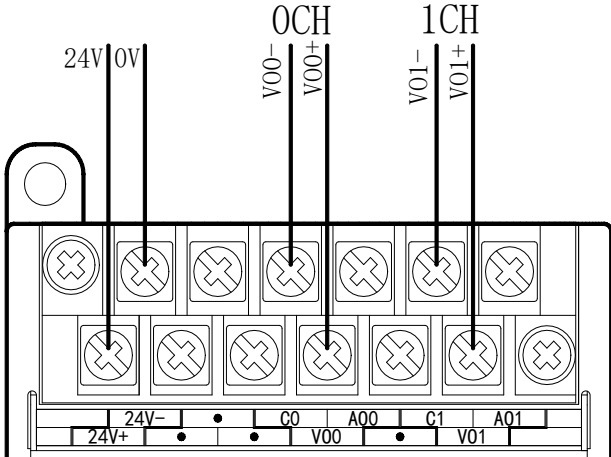

Current input

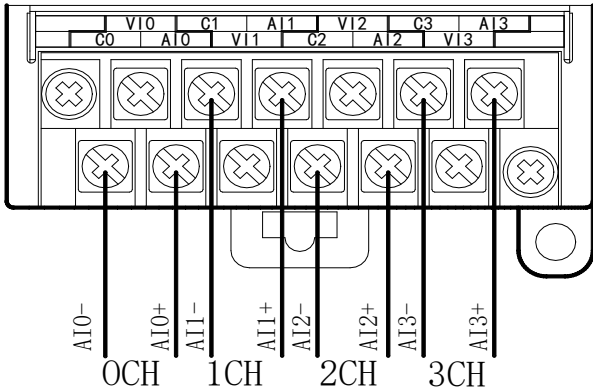

Current output

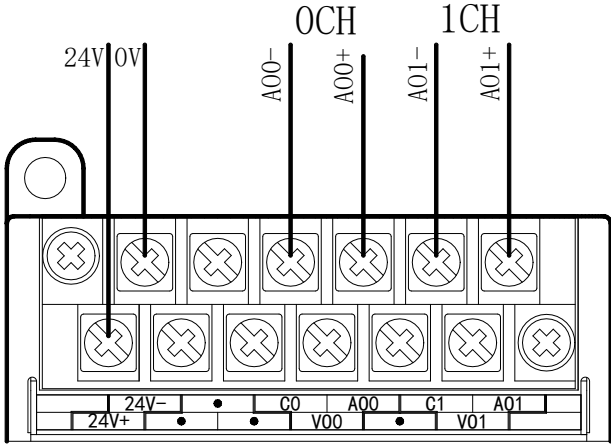

XD-E4AD2DA current output wiring:

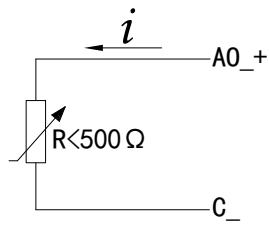

Note: There is no need to connect DC24 power supply in series for current output.

XD-E4AD2DA current input wiring:

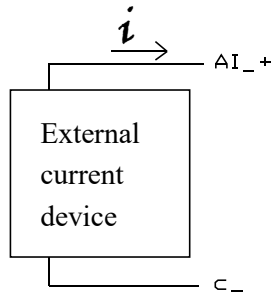

3-6. AD conversion diagram

The relationship between analog input and corresponding digital value:

<p>0~5V analog input</p>	<p>0~10V analog input</p>
<p>-5~5V analog input</p>	<p>-10~10V analog input</p>
<p>0~20mA analog input</p>	<p>4~20mA analog input</p>
<p>-20~20mA analog input</p>	

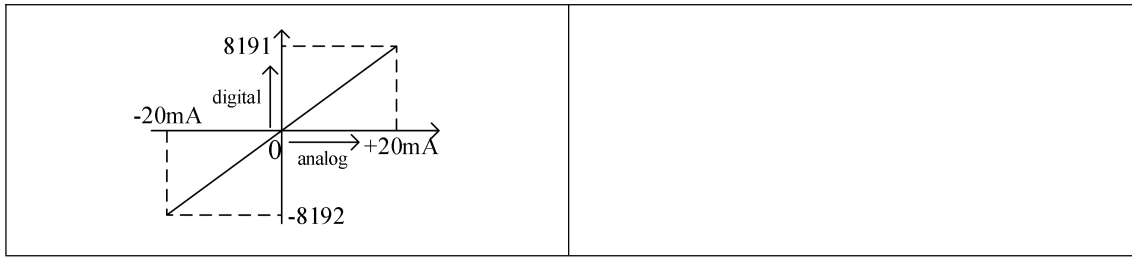

The relationship between digital output value and corresponding analog value:

0~5V analog output	0~10V analog output
-5~5V analog output	-10~10V analog output
0~20mA analog output	4~20mA analog output

Note:

1. When input data exceeds 4095, analog output will keep the max value of 5V, 10V or 20mA.
2. When the AD voltage input is suspended, the corresponding register will show 16383; when the AD current input is suspended, the corresponding register will show 0.

3-7. Programming

Example:

The output signal of the existing pressure sensor needs to be collected (pressure sensor performance parameters: detection pressure range of 0MP ~ 10MP, output analog signal of 4 ~ 20mA), and a 0V ~ 10V voltage signal needs to be output to the inverter.

Analysis:

Since the pressure detection range of the pressure sensor is 0MP ~ 10MP, the corresponding output analog quantity is 4~20mA, and the digital quantity range converted by the expansion module through analog-to-digital conversion is 0~16383; therefore, we can skip the analog quantity 4~20mA in the intermediate conversion link, then the pressure detection range is 0MP ~ 10MP, the corresponding digital quantity range is 0 ~ 16383; $10\text{MP} / 16383 = 0.000610388$. So as long as the real-time value collected in the ID register of the expansion module is multiplied by 0.000610388, the real-time pressure of the current pressure sensor can be calculated; for example, if the number collected in the ID register is 4095, the corresponding pressure is 2.5MP.

Similarly, the range of digital value set in the register QD of the expansion module is 0 ~ 4095, which corresponds to the voltage output signal 0V ~ 10V, and $10\text{V} / 4095 = 0.002442$ indicates how much voltage value is output for each digital value set in the register QD of the expansion module; for example, 3V voltage value needs to be output now, $3\text{V} / 0.002442 = 1228.5$, and the calculated digital value is sent to the corresponding QD register.

Note: please use floating-point operation for calculation, otherwise the calculation accuracy will be affected or even unable to calculate!

The program:

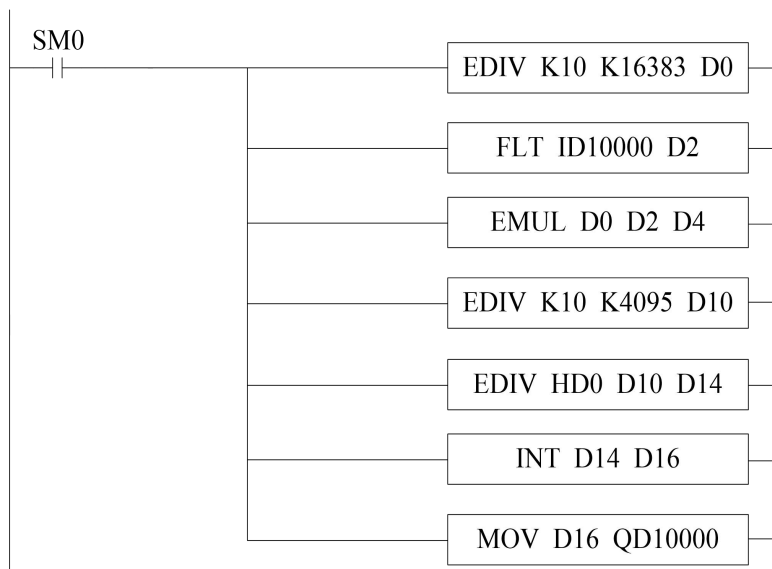

Explanation:

SM0 is normally on coil, which is always on during PLC operation.

When PLC starts to run, analog quantity acquisition first calculates the pressure value corresponding to each digit 1 of the digital quantity collected by the expansion module, and then converts the digital quantity (integer) collected in ID10000 register into floating-point number. The real-time value collected in ID10000 register of

the expansion module multiplied by the pressure value corresponding to each digit 1 of the digital quantity collected by the expansion module is the real-time pressure value.

Similarly, the analog output first calculates the voltage value corresponding to each digit 1 of the digital quantity collected by the expansion module, divides the set target voltage value by the digital quantity corresponding to each digit 1 can get the digital quantity (floating-point number) to be set. Since QD10000 register can only store integers, it is necessary to convert the floating-point number to integer and send to QD10000.

Note: please turn on the enable bit of the used channel, that is, set Y10000 and Y10004 to on.

4. Analog Input Module XD-E4AD

4-1. Specifications

XD-E4AD transform the analog input (current or voltage) to digital value and send to PLC register.

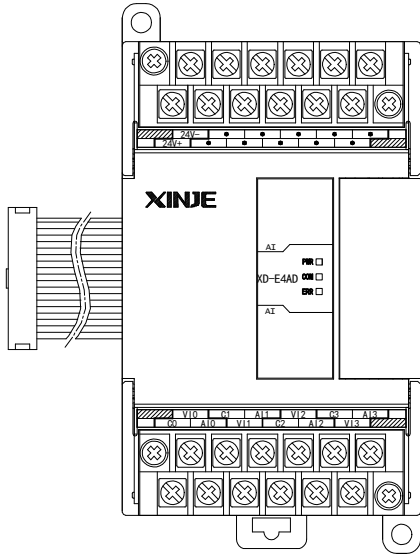

Features:

- 4-channel analog input: two modes of voltage input and current input can be selected.
- 14-bit high precision analog input.
- As the special function module of XD3/XD3E, 10 modules can be connected to the PLC. XD5/XDM/XDC/XD5E/XDME/XDH can extend 16 modules. XD1/XD2 cannot extend modules.

Specifications:

ITEMS	Analog Input (AD)	
	Voltage Input	Current Input
Analog Input Range	0~5V, 0~10V, -5~5V, -10~10V (impedance > 1M)	0~20mA, 4~20mA, -20~20mA (impedance is about 120Ω)
Maximum Input Range	DC ±15V	-40~40mA
Digital Output Range	14 bits binary (0~16383 or -8192~8191)	
Resolution	1/16383(14Bit)	
Synthesis Precision	± 1%	
Conversion Speed	2ms per channel	
Power Supply	DC24V±10%,150mA	
Installation	Fix with M3 screw or install on DIN46277 guilder (Width: 35mm) directly	
Dimension	63mm×108mm×89.9mm	

Note: XD-E4AD module below version V7 does not support- 5 ~ 5V, -10 ~ 10V, -20 ~ 20mA range.

4-2. Terminals

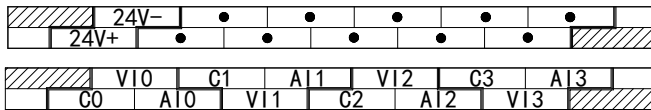

Channel	Terminal name	Signal name
CH0	AI0	Current input
	VI0	Voltage input
	C0	CH0 common terminal
CH1	AI1	Current input
	VI1	Voltage input
	C1	CH1 common terminal
CH2	AI2	Current input
	VI2	Voltage input
	C2	CH2 common terminal
CH3	AI3	Current input
	VI3	Voltage input
	C3	CH3 common terminal
-	24V+	+24V power supply
	24V-	Common terminal of power supply

4-3. I/O address assignment

XD series expansions do not occupy I/O units; the converted value is sent to PLC register directly.

Note: each channel can work after turning on the channel enable bit.

Expansion module 1 address

Channel	AD signal	Channel enable bit (set ON the enable bit to use this channel)	Channel alarm bit
0CH	ID10000	Y10000	X10000
1CH	ID10001	Y10001	X10001
2CH	ID10002	Y10002	X10002
3CH	ID10003	Y10003	X10003

Expansion module 2 address

Channel	AD signal	Channel enable bit (set ON the enable bit to use this channel)	Channel alarm bit
0CH	ID10100	Y10100	X10100
1CH	ID10101	Y10101	X10101
2CH	ID10102	Y10102	X10102
3CH	ID10103	Y10103	X10103

Expansion module 3 address

Channel	AD signal	Channel enable bit (set ON the enable bit to use this channel)	Channel alarm bit
0CH	ID10200	Y10200	X10200
1CH	ID10201	Y10201	X10201
2CH	ID10202	Y10202	X10202
3CH	ID10203	Y10203	X10203

Expansion module 4 address

Channel	AD signal	Channel enable bit (set ON the enable bit to use this channel)	Channel alarm bit
0CH	ID10300	Y10300	X10300
1CH	ID10301	Y10301	X10301
2CH	ID10302	Y10302	X10302

3CH	ID10303	Y10303	X10303
-----	---------	--------	--------

Expansion module 5 address

Channel	AD signal	Channel enable bit (set ON the enable bit to use this channel)	Channel alarm bit
0CH	ID10400	Y10400	X10400
1CH	ID10401	Y10401	X10401
2CH	ID10402	Y10402	X10402
3CH	ID10403	Y10403	X10403

Expansion module 6 address

Channel	AD signal	Channel enable bit (set ON the enable bit to use this channel)	Channel alarm bit
0CH	ID10500	Y10500	X10500
1CH	ID10501	Y10501	X10501
2CH	ID10502	Y10502	X10502
3CH	ID10503	Y10503	X10503

Expansion module 7 address

Channel	AD signal	Channel enable bit (set ON the enable bit to use this channel)	Channel alarm bit
0CH	ID10600	Y10600	X10600
1CH	ID10601	Y10601	X10601
2CH	ID10602	Y10602	X10602
3CH	ID10603	Y10603	X10603

Expansion module 8 address

Channel	AD signal	Channel enable bit (set ON the enable bit to use this channel)	Channel alarm bit
0CH	ID10700	Y10700	X10700
1CH	ID10701	Y10701	X10701
2CH	ID10702	Y10702	X10702
3CH	ID10703	Y10703	X10703

Expansion module 9 address

Channel	AD signal	Channel enable bit (set ON the enable bit to use this channel)	Channel alarm bit
0CH	ID10800	Y11000	X11000
1CH	ID10801	Y11001	X11001
2CH	ID10802	Y11002	X11002
3CH	ID10803	Y11003	X11003

Expansion module 10 address

Channel	AD signal	Channel enable bit (set ON the enable bit to use this channel)	Channel alarm bit
0CH	ID10900	Y11100	X11100
1CH	ID10901	Y11101	X11101
2CH	ID10902	Y11102	X11102
3CH	ID10903	Y11103	X11103

Expansion module 11 address

Channel	AD signal	Channel enable bit (set ON the enable bit to use this channel)	Channel alarm bit
0CH	ID11000	Y11200	X11200
1CH	ID11001	Y11201	X11201
2CH	ID11002	Y11202	X11202
3CH	ID11003	Y11203	X11203

Expansion module 12 address

Channel	AD signal	Channel enable bit (set ON the enable bit to use this channel)	Channel alarm bit
0CH	ID11100	Y11300	X11300
1CH	ID11101	Y11301	X11301
2CH	ID11102	Y11302	X11302
3CH	ID11103	Y11303	X11303

Expansion module 13 address

Channel	AD signal	Channel enable bit (set ON the enable bit to use this channel)	Channel alarm bit
0CH	ID11200	Y11400	X11400
1CH	ID11201	Y11401	X11401
2CH	ID11202	Y11402	X11402
3CH	ID11203	Y11403	X11403

Expansion module 14 address

Channel	AD signal	Channel enable bit (set ON the enable bit to use this channel)	Channel alarm bit
0CH	ID11300	Y11500	X11500
1CH	ID11301	Y11501	X11501
2CH	ID11302	Y11502	X11502
3CH	ID11303	Y11503	X11503

Expansion module 15 address

Channel	AD signal	Channel enable bit (set ON the enable bit to use this channel)	Channel alarm bit
0CH	ID11400	Y11600	X11600
1CH	ID11401	Y11601	X11601
2CH	ID11402	Y11602	X11602
3CH	ID11403	Y11603	X11603

Expansion module 16 address

Channel	AD signal	Channel enable bit (set ON the enable bit to use this channel)	Channel alarm bit
0CH	ID11500	Y11700	X11700
1CH	ID11501	Y11701	X11701
2CH	ID11502	Y11702	X11702
3CH	ID11503	Y11703	X11703

Note:

1. Forbid the unused channel to improve the I/O scanning speed.
2. If set off the enable bit of the input channel, this channel will not accept the data. (the data display is 0).

4-4. Working mode

There are two ways to set the working mode:

1. XDPpro software
2. Flash registers of PLC

XDPpro software:

Open the XDPpro software, click configure/expansion module settings:

Set the model and channel parameters in the following window. Then click write to PLC.

Please restart the PLC after setting.

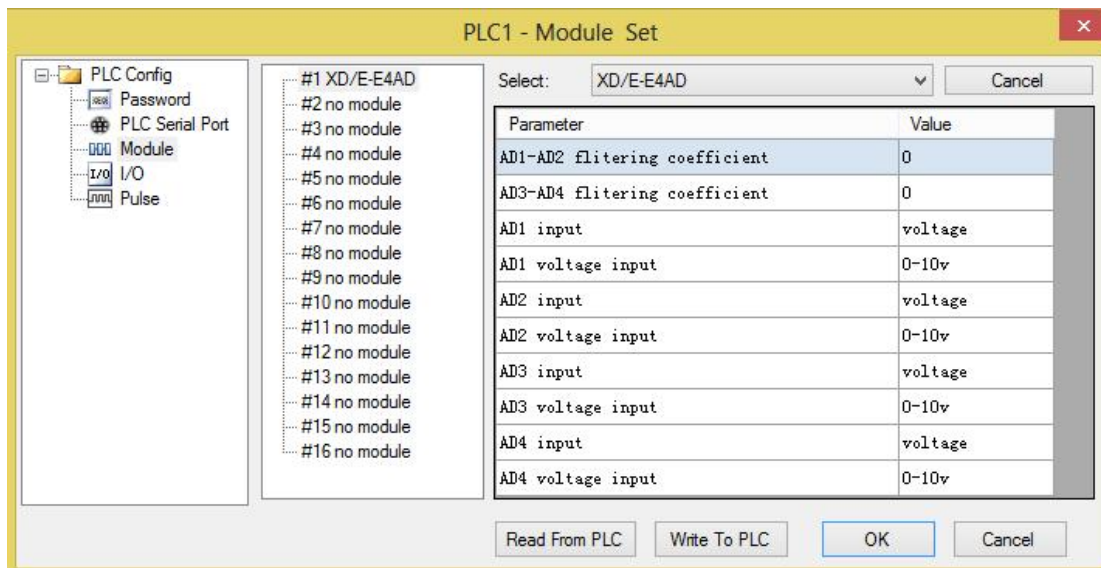

Note:

1. The first-order low-pass filtering method uses this sampling value and the last filtering output value for weighting to get the effective filtering value.
2. The filter coefficient is set to 0 ~ 254 by the user, the smaller the value is, the more stable the data is, but it may cause data lag; when it is set to 1, the filtering effect is the strongest, and when it is set to 254, the filtering effect is the weakest, and the default value is 0 (no filtering).

3. When the module flag bit **Short circuit / circuit breakage / supe... open** is set on, please monitor X but not Y, as Y is channel enable bit.

For example: When the first channel of AD is set to voltage mode and AD detects short circuit / open circuit / over range, X10000 will be set to on;

The first channel of AD is set to current mode. When AD is detected as over range, X10000 will be set to on.

Flash registers:

The working mode can be voltage 0~5V, 0~10V or current 0~20mA, 4~20mA, set through SFD registers of PLC:

Module no.	SFD address	Module no.	SFD address
#1	SFD350~SFD359	#9	SFD430~SFD439
#2	SFD360~SFD369	#10	SFD440~SFD449
#3	SFD370~SFD379	#11	SFD450~SFD459
#4	SFD380~SFD389	#12	SFD460~SFD469
#5	SFD390~SFD399	#13	SFD470~SFD479
#6	SFD400~SFD409	#14	SFD480~SFD489
#7	SFD410~SFD419	#15	SFD490~SFD499
#8	SFD420~SFD429	#16	SFD500~SFD509

Note: As shown in the preceding table, every register set 4 channels mode, each register has 16 bits, from low to high, and every 4 bits set 1 channel mode.

We take module 1 as an example to show how to set:

Register	Bit7	Bit6	Bit5	Bit4	Bit3	Bit2	Bit1	Bit0	Note
SFD350	AD channel 1, 2 filtering coefficient								AD filtering coefficient
	AD channel 3, 4 filtering coefficient								
SFD351	Byte2	Bit7	Bit6	Bit5	Bit4	Bit3	Bit2	Bit1	To set the input range of AD module. Byte2 low 4-bit is to set AD channel 1, high 4-bit is to set AD
		AD2				AD1			
	-	000: 0~10V 001: 0~5V 100: -10~10V 101: -5~5V 010: 0~20mA 011: 4~20mA 110: -20~20mA				-	000: 0~10V 001: 0~5V 100: -10~10V 101: -5~5V 010: 0~20mA 011: 4~20mA 110: -20~20mA		
Byte3	Bit7	Bit6	Bit5	Bit4	Bit3	Bit2	Bit1	Bit0	
	AD4				AD3				

		-	000: 0~10V 001: 0~5V 100: -10~10V 101: -5~5V 010: 0~20mA 011: 4~20mA 110: -20~20mA	-	000: 0~10V 001: 0~5V 100: -10~10V 101: -5~5V 010: 0~20mA 011: 4~20mA 110: -20~20mA	channel 2. Byte3 Low 4-bit is to set AD channel 3, high 4-bit
SFD352	Byte4	AD channel short circuit/open circuit/over range detection switch				is to set
	Byte5	-				AD
SFD353~SFD359					-	channel 4.

For example:

Set module no. 1 channel 3, 2, 1, 0 working mode to 0~20mA, 4~20mA, 0~10V, 0~5V. Set channel 1 and channel 2 filter factor to 254, set channel 3 and channel 4 filter factor to 100.

So the SFD values are:

SFD350=64FEH SFD351=2301H SFD352=0000H SFD353=0000H

4-5. Exterior connection

When make external connection, please note the following items:

- When connect external 24V power, please choose 24V power of PLC to avoid interference.
- To avoid interference, please use shield cable and single-point ground with the shield layer.

Voltage input

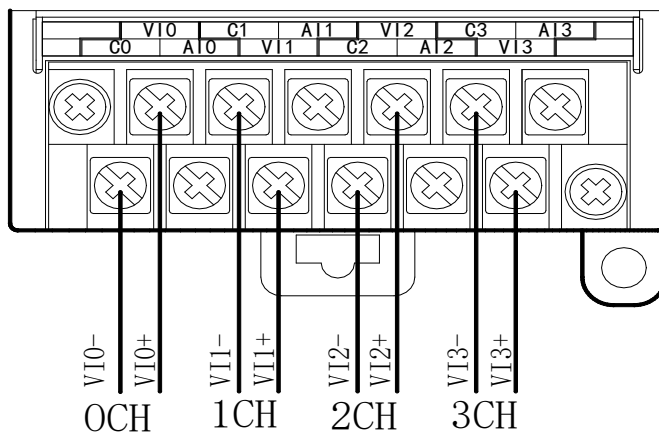

Current input

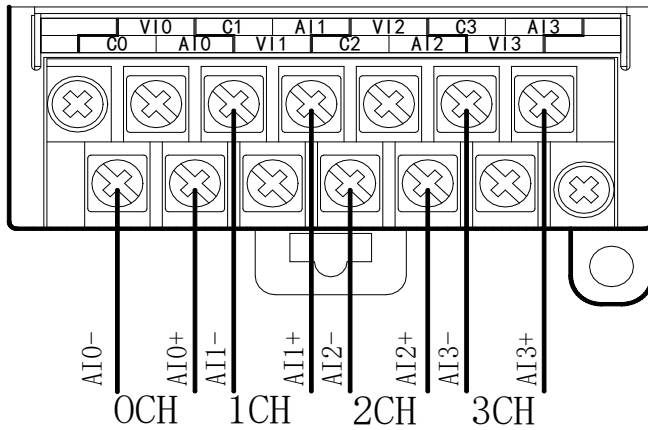

XD-E4AD current input wiring:

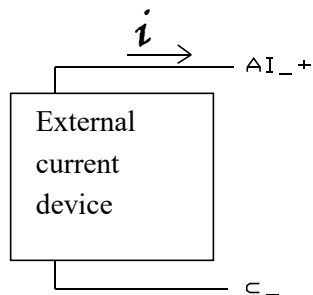

4-6. AD conversion diagram

The relationship between analog input and converted digital value is shown in the following chart:

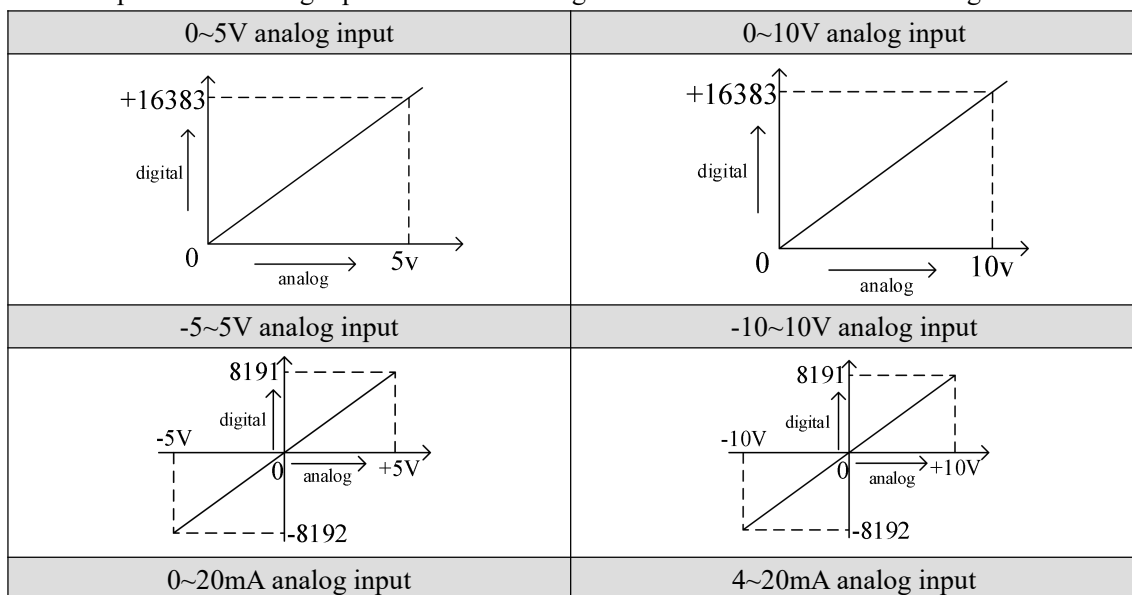

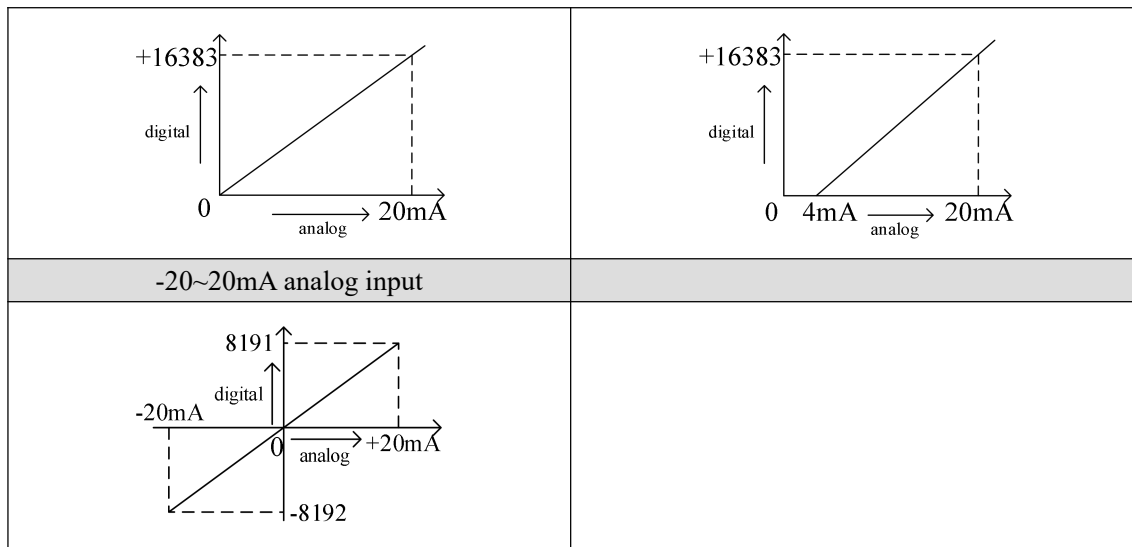

4-7. Programming

Example Real-time read the 4 channels data (take expansion 1 as an example)

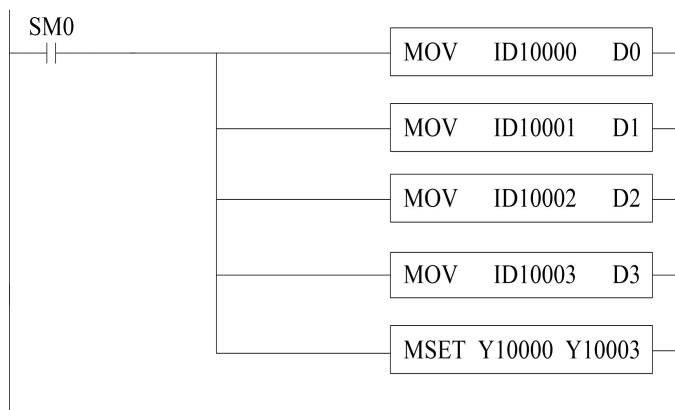

Explanation:

SM0 is always ON coil, it is ON when PLC is running.

Send channel 0 data to PLC register D0,

Send channel 1 data to PLC register D1,

Send channel 2 data to PLC register D2,

Send channel 3 data to PLC register D3.

Set ON all the channel enable bits.

5. Analog input module XD-E8AD

5-1. Specification

XD-E8AD transform the analog value (current or voltage input) to digital value and send to PLC registers.

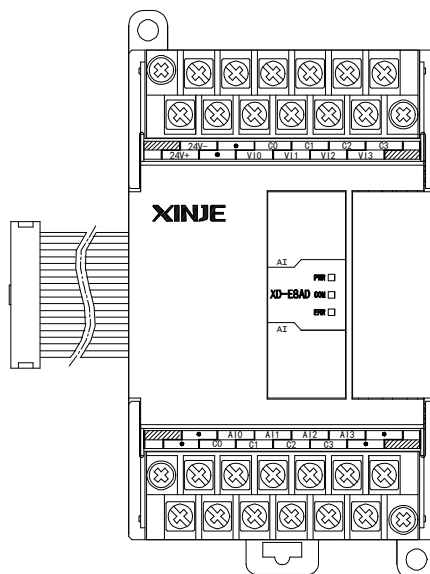

Features:

- 8-channel analog input: first 4-channel voltage input, last 4-channel current input.
- 14-bit high precision analog input.
- As the special function module of XD3/XD3E, 10 modules can be connected to the PLC. XD5/XDM/XDC/XD5E/XDME/XDH can extend 16 modules. XD1/XD2 cannot extend modules.

Specifications:

Items	Voltage input (0CH~3CH)	Current input (4CH~7CH)
Analog input range	0~5V, 0~10V, -10~10V, -5~5V (impedance > 1M)	0~20mA, 4~20mA, -20~20mA (impedance is about 120 Ω)
Max input range	DC ± 15V	-40~40mA
Digital output range	14 bits binary data (0~16383 or -8192~8191)	
Resolution	1/16383(14Bit)	
Integrate Precision	± 1%	
Conversion speed	2ms per channel	
Analog power supply	DC24V±10%,150mA	
Installation	Can be fixed with screw M3 or directly installed on orbit of DIN46277 (width: 35mm)	
Dimension	63mm×108mm×89.9mm	

Note: XD-E8AD module below version V8 does not support -5~5V, -10~10V, -20~20mA input.

5-2. Terminals

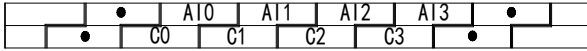
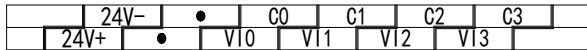

Channel	Terminal name	Signal name
CH0	VI0	VI0+ voltage input
	C0	VI0- voltage input
CH1	VI1	VI1+ voltage input
	C1	VI1- voltage input
CH2	VI2	VI2+ voltage input
	C2	VI2- voltage input
CH3	VI3	VI3+ voltage input
	C3	VI3- voltage input
CH4	AI0	AI0+current input
	C0	AI0- current input
CH5	AI1	AI1+ current input
	C1	AI1- current input
CH6	AI2	AI2+ current input
	C2	AI2- current input
CH7	AI3	AI3+ current input
	C3	AI3- current input
-	24V+	+24V power supply
	24V-	Common terminal of power supply

5-3. I/O distribution

XD series analog expansion modules don't occupy I/O unit; the converted data is directly transferred to PLC register.

Note: each channel can only be used when the enable bit is turned on.

Each channel address:

I/O address list

Register address of expansion module 1:

Channel	AD signal	Channel enable (set ON the enable bit to use this channel)	Channel alarm bit
0CH	ID10000	Y10000	X10000
1CH	ID10001	Y10001	X10001
2CH	ID10002	Y10002	X10002
3CH	ID10003	Y10003	X10003
4CH	ID10004	Y10004	X10004
5CH	ID10005	Y10005	X10005
6CH	ID10006	Y10006	X10006
7CH	ID10007	Y10007	X10007

Register address of expansion module 2:

Channel	AD signal	Channel enable (set ON the enable bit to use this channel)	Channel alarm bit
0CH	ID10100	Y10100	X10100
1CH	ID10101	Y10101	X10101
2CH	ID10102	Y10102	X10102
3CH	ID10103	Y10103	X10103
4CH	ID10104	Y10104	X10104
5CH	ID10105	Y10105	X10105
6CH	ID10106	Y10106	X10106
7CH	ID10107	Y10107	X10107

Register address of expansion module 3:

Channel	AD signal	Channel enable (set ON the enable bit to use this channel)	Channel alarm bit
0CH	ID10200	Y10200	X10200
1CH	ID10201	Y10201	X10201
2CH	ID10202	Y10202	X10202
3CH	ID10203	Y10203	X10203
4CH	ID10204	Y10204	X10204
5CH	ID10205	Y10205	X10205
6CH	ID10206	Y10206	X10206
7CH	ID10207	Y10207	X10207

Register address of expansion module 4:

Channel	AD signal	Channel enable (set ON the enable bit to use this channel)	Channel alarm bit
0CH	ID10300	Y10300	X10300
1CH	ID10301	Y10301	X10301
2CH	ID10302	Y10302	X10302
3CH	ID10303	Y10303	X10303
4CH	ID10304	Y10304	X10304
5CH	ID10305	Y10305	X10305
6CH	ID10306	Y10306	X10306
7CH	ID10307	Y10307	X10307

Register address of expansion module 5:

Channel	AD signal	Channel enable (set ON the enable bit to use this channel)	Channel alarm bit
0CH	ID10400	Y10400	X10400
1CH	ID10401	Y10401	X10401
2CH	ID10402	Y10402	X10402
3CH	ID10403	Y10403	X10403
4CH	ID10404	Y10404	X10404
5CH	ID10405	Y10405	X10405
6CH	ID10406	Y10406	X10406
7CH	ID10407	Y10407	X10407

Register address of expansion module 6:

Channel	AD signal	Channel enable (set ON the enable bit to use this channel)	Channel alarm bit
0CH	ID10500	Y10500	X10500
1CH	ID10501	Y10501	X10501
2CH	ID10502	Y10502	X10502
3CH	ID10503	Y10503	X10503
4CH	ID10504	Y10504	X10504
5CH	ID10505	Y10505	X10505
6CH	ID10506	Y10506	X10506

7CH	ID10507	Y10507	X10507
-----	---------	--------	--------

Register address of expansion module 7:

Channel	AD signal	Channel enable (set ON the enable bit to use this channel)	Channel alarm bit
0CH	ID10600	Y10600	X10600
1CH	ID10601	Y10601	X10601
2CH	ID10602	Y10602	X10602
3CH	ID10603	Y10603	X10603
4CH	ID10604	Y10604	X10604
5CH	ID10605	Y10605	X10605
6CH	ID10606	Y10606	X10606
7CH	ID10607	Y10607	X10607

Register address of expansion module 8:

Channel	AD signal	Channel enable (set ON the enable bit to use this channel)	Channel alarm bit
0CH	ID10700	Y10700	X10700
1CH	ID10701	Y10701	X10701
2CH	ID10702	Y10702	X10702
3CH	ID10703	Y10703	X10703
4CH	ID10704	Y10704	X10704
5CH	ID10705	Y10705	X10705
6CH	ID10706	Y10706	X10706
7CH	ID10707	Y10707	X10707

Register address of expansion module 9:

Channel	AD signal	Channel enable (set ON the enable bit to use this channel)	Channel alarm bit
0CH	ID10800	Y11000	X11000
1CH	ID10801	Y11001	X11001
2CH	ID10802	Y11002	X11002
3CH	ID10803	Y11003	X11003
4CH	ID10804	Y11004	X11004
5CH	ID10805	Y11005	X11005

6CH	ID10806	Y11006	X11006
7CH	ID10807	Y11007	X11007

Register address of expansion module 10:

Channel	AD signal	Channel enable (set ON the enable bit to use this channel)	Channel alarm bit
0CH	ID10900	Y11100	X11100
1CH	ID10901	Y11101	X11101
2CH	ID10902	Y11102	X11102
3CH	ID10903	Y11103	X11103
4CH	ID10904	Y11104	X11104
5CH	ID10905	Y11105	X11105
6CH	ID10906	Y11106	X11106
7CH	ID10907	Y11107	X11107

Register address of expansion module 11:

Channel	AD signal	Channel enable (set ON the enable bit to use this channel)	Channel alarm bit
0CH	ID11000	Y11200	X11200
1CH	ID11001	Y11201	X11201
2CH	ID11002	Y11202	X11202
3CH	ID11003	Y11203	X11203
4CH	ID11004	Y11204	X11204
5CH	ID11005	Y11205	X11205
6CH	ID11006	Y11206	X11206
7CH	ID11007	Y11207	X11207

Register address of expansion module 12:

Channel	AD signal	Channel enable (set ON the enable bit to use this channel)	Channel alarm bit
0CH	ID11100	Y11300	X11300
1CH	ID11101	Y11301	X11301
2CH	ID11102	Y11302	X11302
3CH	ID11103	Y11303	X11303
4CH	ID11104	Y11304	X11304

5CH	ID11105	Y11305	X11305
6CH	ID11106	Y11306	X11306
7CH	ID11107	Y11307	X11307

Register address of expansion module 13:

Channel	AD signal	Channel enable (set ON the enable bit to use this channel)	Channel alarm bit
0CH	ID11200	Y11400	X11400
1CH	ID11201	Y11401	X11401
2CH	ID11202	Y11402	X11402
3CH	ID11203	Y11403	X11403
4CH	ID11204	Y11404	X11404
5CH	ID11205	Y11405	X11405
6CH	ID11206	Y11406	X11406
7CH	ID11207	Y11407	X11407

Register address of expansion module 14:

Channel	AD signal	Channel enable (set ON the enable bit to use this channel)	Channel alarm bit
0CH	ID11300	Y11500	X11500
1CH	ID11301	Y11501	X11501
2CH	ID11302	Y11502	X11502
3CH	ID11303	Y11503	X11503
4CH	ID11304	Y11504	X11504
5CH	ID11305	Y11505	X11505
6CH	ID11306	Y11506	X11506
7CH	ID11307	Y11507	X11507

Register address of expansion module 15:

Channel	AD signal	Channel enable (set ON the enable bit to use this channel)	Channel alarm bit
0CH	ID11400	Y11600	X11600
1CH	ID11401	Y11601	X11601
2CH	ID11402	Y11602	X11602
3CH	ID11403	Y11603	X11603
4CH	ID11404	Y11604	X11604
5CH	ID11405	Y11605	X11605
6CH	ID11406	Y11606	X11606
7CH	ID11407	Y11607	X11607

Register address of expansion module 16:

Channel	AD signal	Channel enable (set ON the enable bit to use this channel)	Channel alarm bit
0CH	ID11500	Y11700	X11700
1CH	ID11501	Y11701	X11701
2CH	ID11502	Y11702	X11702
3CH	ID11503	Y11703	X11703
4CH	ID11504	Y11704	X11704
5CH	ID11505	Y11705	X11705
6CH	ID11506	Y11706	X11706
7CH	ID11507	Y11707	X11707

Note:

1. Forbid the unused channel to improve the I/O scanning speed.
2. If set off the enable bit of the channel, this channel will not accept the data. (the data display is 0).

5-4. Working mode

There are two ways to set the working mode:

1. XDPpro software
2. Flash registers of PLC

XDPpro software:

Open the XDPpro software, click configure/expansion module settings:

Set the model and channel parameters in the following window. Then click write to PLC.

Please restart the PLC after setting.

Note:

1. The first-order low-pass filtering method uses this sampling value and the last filtering output value for weighting to get the effective filtering value.

2. The filter coefficient is set to 0 ~ 254 by the user, the smaller the value is, the more stable the data is, but it may cause data lag; when it is set to 1, the filtering effect is the strongest, and when it is set to 254, the filtering effect is the weakest, and the default value is 0 (no filtering).

3. When the module flag bit Short circuit / circuit breakage / supe... open is set on, please monitor X but not Y, as Y is channel enable bit.

For example: When the first channel of AD is set to voltage mode and AD detects short circuit / open circuit / over range, X10000 will be set to on;

The fifth channel of AD is set to current mode. When AD is detected as over range, X10004 will be set to on.

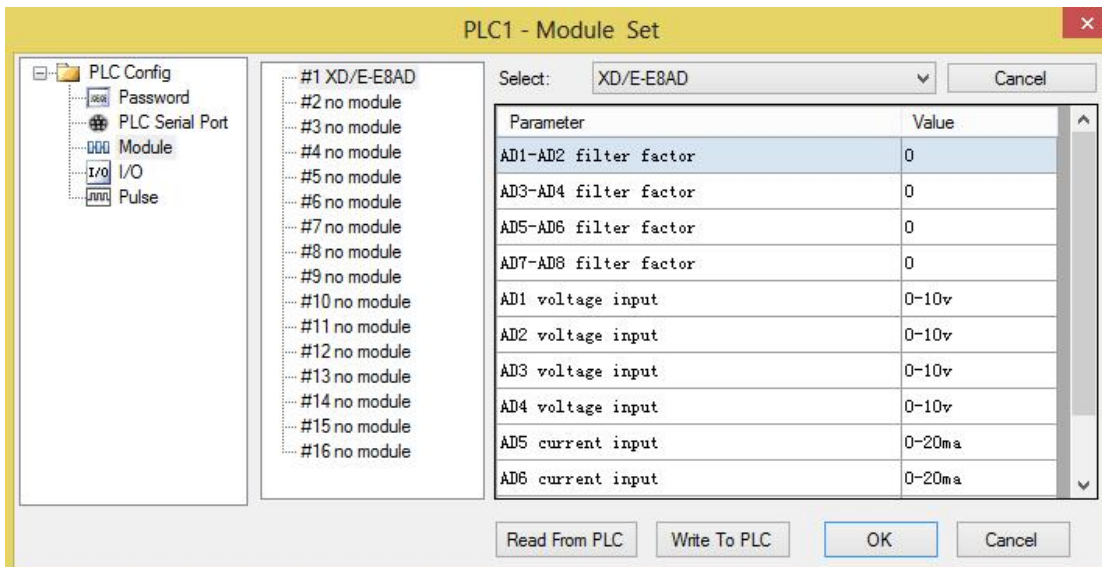

Flash registers:

0CH~3CH channels: voltage 0~5V, 0~10V, -5~5V, -10~10V.

4CH~7CH channels: current 0~20mA, 4~20mA, -20~20mA.

Set the modes through SFD registers of PLC. See the following table:

Module no.	SFD address	Module no.	SFD address
#1	SFD350~SFD359	#9	SFD430~SFD439
#2	SFD360~SFD369	#10	SFD440~SFD449
#3	SFD370~SFD379	#11	SFD450~SFD459

#4	SFD380~SFD389	#12	SFD460~SFD469
#5	SFD390~SFD399	#13	SFD470~SFD479
#6	SFD400~SFD409	#14	SFD480~SFD489
#7	SFD410~SFD419	#15	SFD490~SFD499
#8	SFD420~SFD429	#16	SFD500~SFD509

Note: each SFD register can set 4 channels mode. Each register has 16 bits, every 4 bits set one channel mode.

SFD bit definition:

Register		Bit7	Bit6	Bit5	Bit4	Bit3	Bit2	Bit1	Bit0	Note
SFD350	Byte0	AD channel 2, 1 filtering coefficient								AD filtering coefficient
	Byte1	AD channel 4, 3 filtering coefficient								
SFD351	Byte2	AD channel 6, 5 filtering coefficient								
	Byte3	AD channel 8, 7 filtering coefficient								
SFD352	Byte4	Bit7	Bit6	Bit5	Bit4	Bit3	Bit2	Bit1	Bit0	To define the AD input range. Byte4 low 4 bits set channel 1 mode, high 4 bits set channel 2 mode. Byte5 low 4 bits set channel 3 mode, high 4 bits set channel 4 mode. Byte6 low 4 bits set channel 5 mode, high 4 bits set channel 6 mode. Byte7 low 4 bits set channel 7 mode, high 4 bits set channel 8 mode.
		AD2				AD1				
		0000: 0~10V				0000: 0~10V				
		0001: 0~5V				0001: 0~5V				
	0010: -10~10V				0010: -10~10V					
	0011: -5~5V				0011: -5~5V					
	Byte5	Bit7	Bit6	Bit5	Bit4	Bit3	Bit2	Bit1	Bit0	
		AD4				AD3				
0000: 0~10V				0000: 0~10V						
0001: 0~5V				0001: 0~5V						
0010: -10~10V				0010: -10~10V						
0011: -5~5V				0011: -5~5V						
SFD353	Byte6	Bit7	Bit6	Bit5	Bit4	Bit3	Bit2	Bit1	Bit0	
		AD6				AD5				
		1000: 0~20mA				1000: 0~20mA				
	1001: 4~20mA				1001: 4~20mA					
	1010: -20~20mA				1010: -20~20mA					
	Byte7	Bit7	Bit6	Bit5	Bit4	Bit3	Bit2	Bit1	Bit0	
AD8				AD7						

		1000: 0~20mA 1001: 4~20mA 1010: -20~20mA	1000: 0~20mA 1001: 4~20mA 1010: -20~20mA	
SFD354	Byte8	AD channel short circuit/open circuit/over range detection switch		
	Byte9	-		
SFD355~ SFD359		-		

For example: set module no.1 channel 1 and channel 0 mode to 0~10V. Set channel 3 and channel 2 mode to 0~5V. Set channel 5 and channel 4 mode to 0~20mA. Set channel 7 and channel 6 mode to 4~20mA. The filter factor of channel 0 to channel 3 is 254. The filter factor of channel 4 to channel 7 is 100.

Then the SFD350=FFFEH SFD351=6464H SFD352=1100H SFD353=1100H

5-5. Exterior connection

Notes:

- When connect external +24V power, please use the 24V power of PLC to avoid interference.
- To avoid interference, please use shield cable and single point ground for the shield layer.

Voltage input:

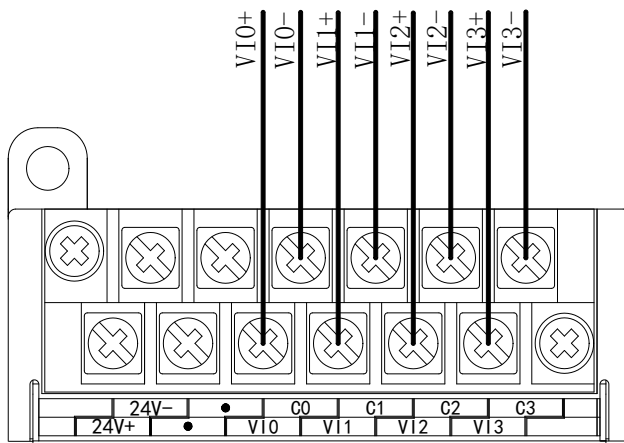

Current input:

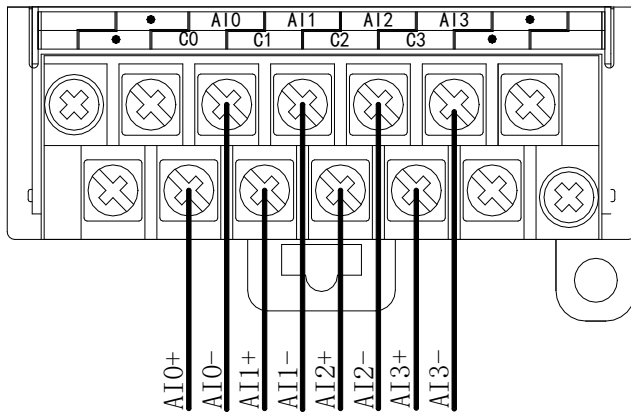

XD-E8AD current input wiring:

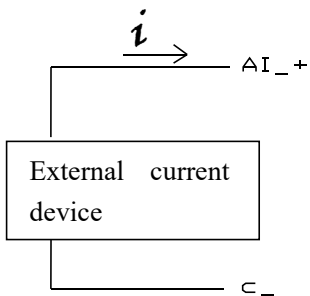

5-6. AD conversion diagram

The relationship between analog value and digital value is shown as the following diagram:

0~5V analog input	0~10V analog input
-5~5V analog input	-10~10V analog input
0~20mA analog input	4~20mA analog input

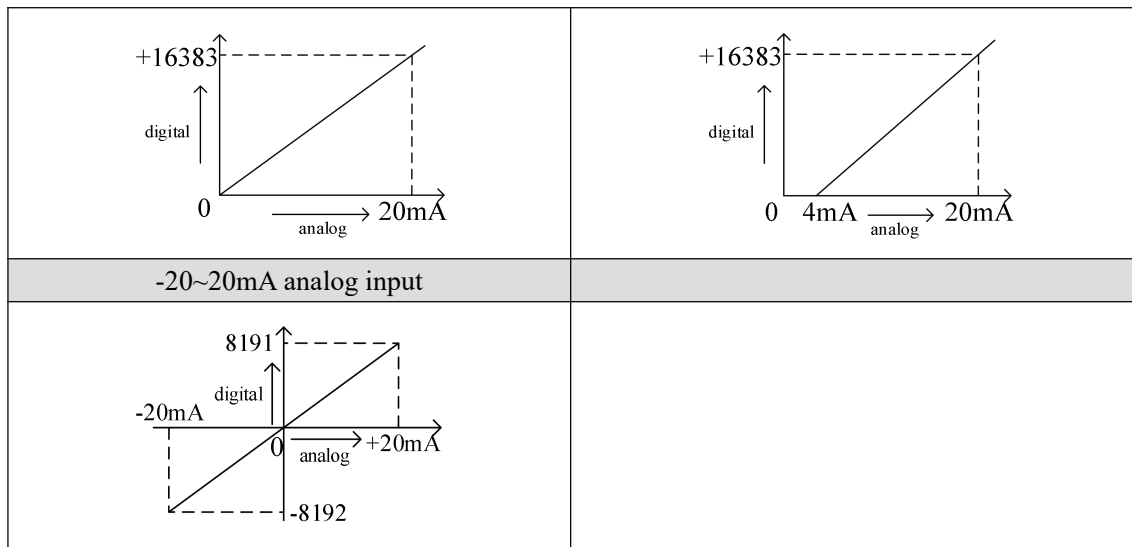

5-7. Program application

Real-time read the data of the 8 channels (module no.1)

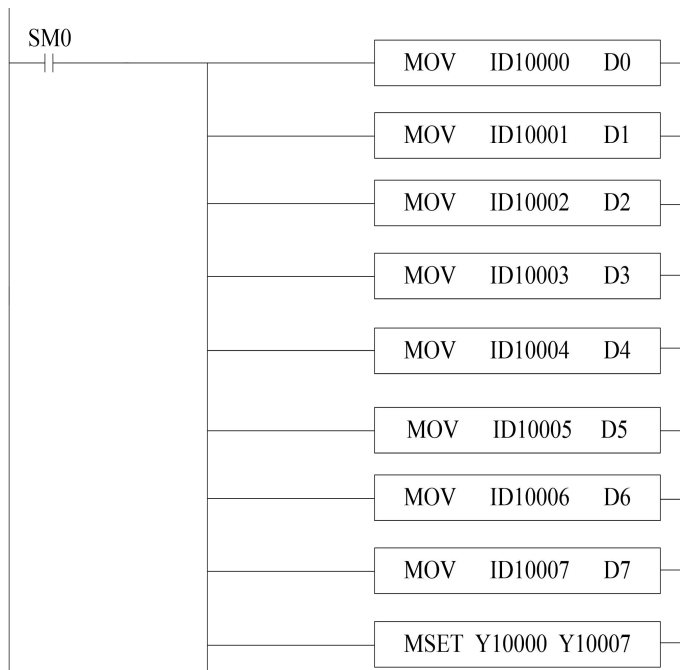

Explanation:

SM0 is always ON coil.

PLC is running. PLC keeps on writing channel 0 data to D0, channel 1 data to D1, channel 2 data to D2, channel 3 data to D3, channel 4 data to D4, channel 5 data to D5, channel 6 data to D6, channel 7 data to D7.
Set ON all the channels enable bits.

6. Analog input module XD-E8AD-A

6-1. Specification

XD-E8AD-A transform the analog value (current input) to digital value and send to PLC registers.

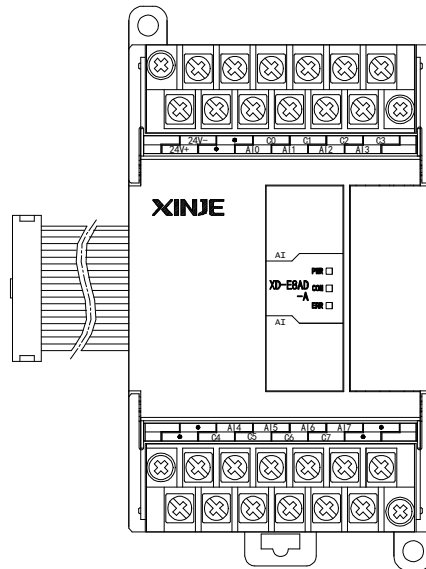

Features:

- 8-channel analog input: current input.
- 14-bit high precision analog input.
- As a special function module of XD series, XD3/XD3E can connect up to 10 modules on the right side of PLC main unit, XD5/XDM/XDC/XD5E/XDME/XDH can expand 16 modules, XD1/XD2 does not support expansion modules.

Specifications:

Items	Current input
Analog input range	0~20mA, 4~20mA, -20~20mA (impedance is about 120Ω)
Max input range	-40~40mA
Digital output range	14 bits binary data (0~16383 or -8192~8191)
Resolution	1/16383(14Bit)
Integrate Precision	±1%
Conversion speed	2ms per channel
Analog power supply	DC24V±10%,150mA
Installation	Can be fixed with screw M3 or directly installed on orbit of DIN46277 (width: 35mm)
Dimension	63mm×108mm×89.9mm

6-2. Terminals

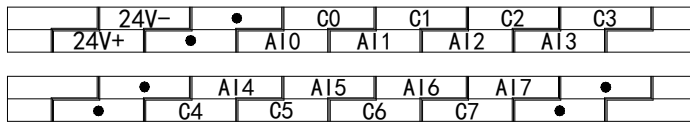

Channel	Terminal name	Signal name
CH0	AI0	Current input
	C0	CH0 input common terminal
CH1	AI1	Current input
	C1	CH1 input common terminal
CH2	AI2	Current input
	C2	CH2 input common terminal
CH3	AI3	Current input
	C3	CH3 input common terminal
CH4	AI4	Current input
	C4	CH4 input common terminal
CH5	AI5	Current input
	C5	CH5 input common terminal
CH6	AI6	Current input
	C6	CH6 input common terminal
CH7	AI7	Current input
	C7	CH7 input common terminal
-	24V+	+24V power supply
	24V-	Common terminal of power supply

6-3. I/O distribution

XD series analog expansion modules don't occupy I/O unit; the converted data is directly transferred to PLC register. Each channel address:

Note: each channel can only be used when the enable bit is turned on.

I/O address list

Register address of expansion module 1:

Channel	AD signal	Channel enable (set ON the enable bit to use this channel)	Channel alarm bit
0CH	ID10000	Y10000	X10000
1CH	ID10001	Y10001	X10001
2CH	ID10002	Y10002	X10002
3CH	ID10003	Y10003	X10003
4CH	ID10004	Y10004	X10004
5CH	ID10005	Y10005	X10005
6CH	ID10006	Y10006	X10006
7CH	ID10007	Y10007	X10007

Register address of expansion module 2:

Channel	AD signal	Channel enable (set ON the enable bit to use this channel)	Channel alarm bit
0CH	ID10100	Y10100	X10100
1CH	ID10101	Y10101	X10101
2CH	ID10102	Y10102	X10102
3CH	ID10103	Y10103	X10103
4CH	ID10104	Y10104	X10104
5CH	ID10105	Y10105	X10105
6CH	ID10106	Y10106	X10106
7CH	ID10107	Y10107	X10107

Register address of expansion module 3:

Channel	AD signal	Channel enable (set ON the enable bit to use this channel)	Channel alarm bit
0CH	ID10200	Y10200	X10200
1CH	ID10201	Y10201	X10201
2CH	ID10202	Y10202	X10202
3CH	ID10203	Y10203	X10203
4CH	ID10204	Y10204	X10204
5CH	ID10205	Y10205	X10205
6CH	ID10206	Y10206	X10206
7CH	ID10207	Y10207	X10207

Register address of expansion module 4:

Channel	AD signal	Channel enable (set ON the enable bit to use this channel)	Channel alarm bit
0CH	ID10300	Y10300	X10300
1CH	ID10301	Y10301	X10301
2CH	ID10302	Y10302	X10302
3CH	ID10303	Y10303	X10303
4CH	ID10304	Y10304	X10304
5CH	ID10305	Y10305	X10305
6CH	ID10306	Y10306	X10306
7CH	ID10307	Y10307	X10307

Register address of expansion module 5:

Channel	AD signal	Channel enable (set ON the enable bit to use this channel)	Channel alarm bit
0CH	ID10400	Y10400	X10400
1CH	ID10401	Y10401	X10401
2CH	ID10402	Y10402	X10402
3CH	ID10403	Y10403	X10403
4CH	ID10404	Y10404	X10404
5CH	ID10405	Y10405	X10405
6CH	ID10406	Y10406	X10406
7CH	ID10407	Y10407	X10407

Register address of expansion module 6:

Channel	AD signal	Channel enable (set ON the enable bit to use this channel)	Channel alarm bit
0CH	ID10500	Y10500	X10500
1CH	ID10501	Y10501	X10501
2CH	ID10502	Y10502	X10502
3CH	ID10503	Y10503	X10503
4CH	ID10504	Y10504	X10504
5CH	ID10505	Y10505	X10505
6CH	ID10506	Y10506	X10506

7CH	ID10507	Y10507	X10507
-----	---------	--------	--------

Register address of expansion module 7:

Channel	AD signal	Channel enable (set ON the enable bit to use this channel)	Channel alarm bit
0CH	ID10600	Y10600	X10600
1CH	ID10601	Y10601	X10601
2CH	ID10602	Y10602	X10602
3CH	ID10603	Y10603	X10603
4CH	ID10604	Y10604	X10604
5CH	ID10605	Y10605	X10605
6CH	ID10606	Y10606	X10606
7CH	ID10607	Y10607	X10607

Register address of expansion module 8:

Channel	AD signal	Channel enable (set ON the enable bit to use this channel)	Channel alarm bit
0CH	ID10700	Y10700	X10700
1CH	ID10701	Y10701	X10701
2CH	ID10702	Y10702	X10702
3CH	ID10703	Y10703	X10703
4CH	ID10704	Y10704	X10704
5CH	ID10705	Y10705	X10705
6CH	ID10706	Y10706	X10706
7CH	ID10707	Y10707	X10707

Register address of expansion module 9:

Channel	AD signal	Channel enable (set ON the enable bit to use this channel)	Channel alarm bit
0CH	ID10800	Y11000	X11000
1CH	ID10801	Y11001	X11001
2CH	ID10802	Y11002	X11002
3CH	ID10803	Y11003	X11003
4CH	ID10804	Y11004	X11004
5CH	ID10805	Y11005	X11005

6CH	ID10806	Y11006	X11006
7CH	ID10807	Y11007	X11007

Register address of expansion module 10:

Channel	AD signal	Channel enable (set ON the enable bit to use this channel)	Channel alarm bit
0CH	ID10900	Y11100	X11100
1CH	ID10901	Y11101	X11101
2CH	ID10902	Y11102	X11102
3CH	ID10903	Y11103	X11103
4CH	ID10904	Y11104	X11104
5CH	ID10905	Y11105	X11105
6CH	ID10906	Y11106	X11106
7CH	ID10907	Y11107	X11107

Register address of expansion module 11:

Channel	AD signal	Channel enable (set ON the enable bit to use this channel)	Channel alarm bit
0CH	ID11000	Y11200	X11200
1CH	ID11001	Y11201	X11201
2CH	ID11002	Y11202	X11202
3CH	ID11003	Y11203	X11203
4CH	ID11004	Y11204	X11204
5CH	ID11005	Y11205	X11205
6CH	ID11006	Y11206	X11206
7CH	ID11007	Y11207	X11207

Register address of expansion module 12:

Channel	AD signal	Channel enable (set ON the enable bit to use this channel)	Channel alarm bit
0CH	ID11100	Y11300	X11300
1CH	ID11101	Y11301	X11301
2CH	ID11102	Y11302	X11302
3CH	ID11103	Y11303	X11303
4CH	ID11104	Y11304	X11304

5CH	ID11105	Y11305	X11305
6CH	ID11106	Y11306	X11306
7CH	ID11107	Y11307	X11307

Register address of expansion module 13:

Channel	AD signal	Channel enable (set ON the enable bit to use this channel)	Channel alarm bit
0CH	ID11200	Y11400	X11400
1CH	ID11201	Y11401	X11401
2CH	ID11202	Y11402	X11402
3CH	ID11203	Y11403	X11403
4CH	ID11204	Y11404	X11404
5CH	ID11205	Y11405	X11405
6CH	ID11206	Y11406	X11406
7CH	ID11207	Y11407	X11407

Register address of expansion module 14:

Channel	AD signal	Channel enable (set ON the enable bit to use this channel)	Channel alarm bit
0CH	ID11300	Y11500	X11500
1CH	ID11301	Y11501	X11501
2CH	ID11302	Y11502	X11502
3CH	ID11303	Y11503	X11503
4CH	ID11304	Y11504	X11504
5CH	ID11305	Y11505	X11505
6CH	ID11306	Y11506	X11506
7CH	ID11307	Y11507	X11507

Register address of expansion module 15:

Channel	AD signal	Channel enable (set ON the enable bit to use this channel)	Channel alarm bit
0CH	ID11400	Y11600	X11600
1CH	ID11401	Y11601	X11601
2CH	ID11402	Y11602	X11602
3CH	ID11403	Y11603	X11603
4CH	ID11404	Y11604	X11604
5CH	ID11405	Y11605	X11605
6CH	ID11406	Y11606	X11606
7CH	ID11407	Y11607	X11607

Register address of expansion module 16:

Channel	AD signal	Channel enable (set ON the enable bit to use this channel)	Channel alarm bit
0CH	ID11500	Y11700	X11700
1CH	ID11501	Y11701	X11701
2CH	ID11502	Y11702	X11702
3CH	ID11503	Y11703	X11703
4CH	ID11504	Y11704	X11704
5CH	ID11505	Y11705	X11705
6CH	ID11506	Y11706	X11706
7CH	ID11507	Y11707	X11707

Note:

1. Forbid the unused channel to improve the I/O scanning speed.
2. If set off the enable bit of the channel, this channel will not accept the data. (the data display is 0).

6-4. Working mode

There are two ways to set the working mode:

1. XDPpro software
2. Flash registers of PLC

XDPpro software:

Open the XDPpro software, click configure/expansion module settings:

Set the model and channel parameters in the following window. Then click write to PLC.

Please restart the PLC after setting.

Note:

1. The first-order low-pass filtering method uses this sampling value and the last filtering output value for weighting to get the effective filtering value.

2. The filter coefficient is set to 0 ~ 254 by the user, the smaller the value is, the more stable the data is, but it may cause data lag; when it is set to 1, the filtering effect is the strongest, and when it is set to 254, the filtering effect is the weakest, and the default value is 0 (no filtering).

3. When the module flag bit Short circuit / circuit breakage / supe... open is set on, please monitor X but not Y, as Y is channel enable bit.

For example, AD channel 1 is current mode, AD detection is over range, X10000 will be ON.

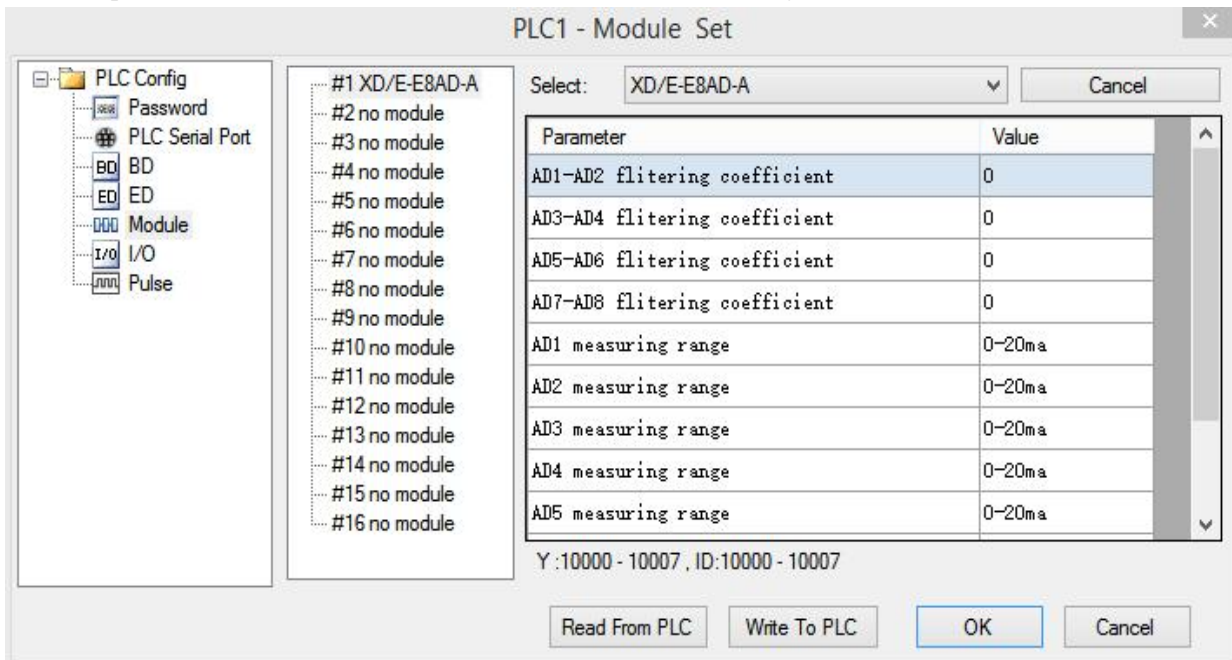

Flash registers:

The module input is current mode, the current range include 0~20mA, 4~20mA, -20~20mA. Set the modes through SFD registers of PLC. See the following table:

Module no.	SFD address	Module no.	SFD address
#1	SFD350~SFD359	#9	SFD430~SFD439
#2	SFD360~SFD369	#10	SFD440~SFD449
#3	SFD370~SFD379	#11	SFD450~SFD459

#4	SFD380~SFD389	#12	SFD460~SFD469
#5	SFD390~SFD399	#13	SFD470~SFD479
#6	SFD400~SFD409	#14	SFD480~SFD489
#7	SFD410~SFD419	#15	SFD490~SFD499
#8	SFD420~SFD429	#16	SFD500~SFD509

Note: each SFD register can set 4 channels mode. Each register has 16 bits, every 4 bits set one channel mode.

SFD bit definition:

Register		Bit7	Bit6	Bit5	Bit4	Bit3	Bit2	Bit1	Bit0	Note
SFD350	Byte0	AD channel 2, 1 filtering coefficient								AD filtering coefficient
	Byte1	AD channel 4, 3 filtering coefficient								
SFD351	Byte2	AD channel 6, 5 filtering coefficient								
	Byte3	AD channel 8, 7 filtering coefficient								
SFD352	Byte4	Bit7	Bit6	Bit5	Bit4	Bit3	Bit2	Bit1	Bit0	To define the AD input range. Byte4 low 4 bits set channel 1 mode, high 4 bits set channel 2 mode. Byte5 low 4 bits set channel 3 mode, high 4 bits set channel 4 mode. Byte6 low 4 bits set channel 5 mode, high 4 bits set channel 6 mode. Byte7 low 4 bits set
		AD2				AD1				
	1000: 0~20mA 1001: 4~20mA 1010: -20~20mA				1000: 0~20mA 1001: 4~20mA 1010: -20~20mA					
	Byte5	Bit7	Bit6	Bit5	Bit4	Bit3	Bit2	Bit1	Bit0	
AD4				AD3						
1000: 0~20mA 1001: 4~20mA 1010: -20~20mA				1000: 0~20mA 1001: 4~20mA 1010: -20~20mA						
SFD353	Byte6	Bit7	Bit6	Bit5	Bit4	Bit3	Bit2	Bit1	Bit0	
		AD6				AD5				

		1000: 0~20mA 1001: 4~20mA 1010: -20~20mA	1000: 0~20mA 1001: 4~20mA 1010: -20~20mA	channel 7 mode, high 4 bits set channel 8 mode.									
	Byte7	Bit7	Bit6					Bit5	Bit4	Bit3	Bit2	Bit1	Bit0
		AD8						AD7					
		1000: 0~20mA 1001: 4~20mA 1010: -20~20mA	1000: 0~20mA 1001: 4~20mA 1010: -20~20mA										
SFD354	Byte8	AD channel short circuit/open circuit/over range detection switch											
	Byte9	-											
SFD355~ SFD359		-											

For example: set module no.1 channel 1 and channel 0 mode to 0~20mA. Set channel 3 and channel 2 mode to 4~20mA. Set channel 5 and channel 4 mode to 0~20mA. Set channel 7 and channel 6 mode to -20~20mA. The filter factor of channel 0 to channel 3 is 254. The filter factor of channel 4 to channel 7 is 100. Then the SFD350=FEFEH SFD351=6464H SFD352=98H SFD353=A8H

6-5. Exterior connection

Notes:

- When connect external +24V power, please use the 24V power of PLC to avoid interference.
- To avoid interference, please use shield cable and single point ground for the shield layer.

Current input:

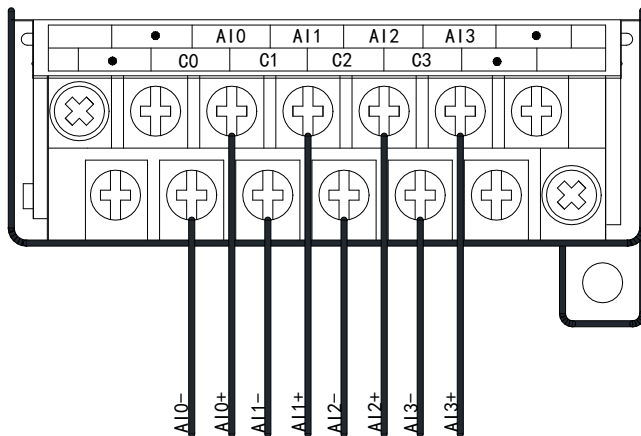

XD-E8AD-A current input wiring:

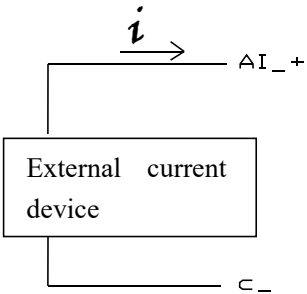

6-6. AD conversion diagram

The relationship between analog value and digital value is shown as the following diagram:

<p style="text-align: center;">0~20mA current input</p>	<p style="text-align: center;">4~20mA current input</p>
<p style="text-align: center;">-20~20mA current input</p>	

6-7. Program application

Real-time read the data of the 8 channels (module no.1)

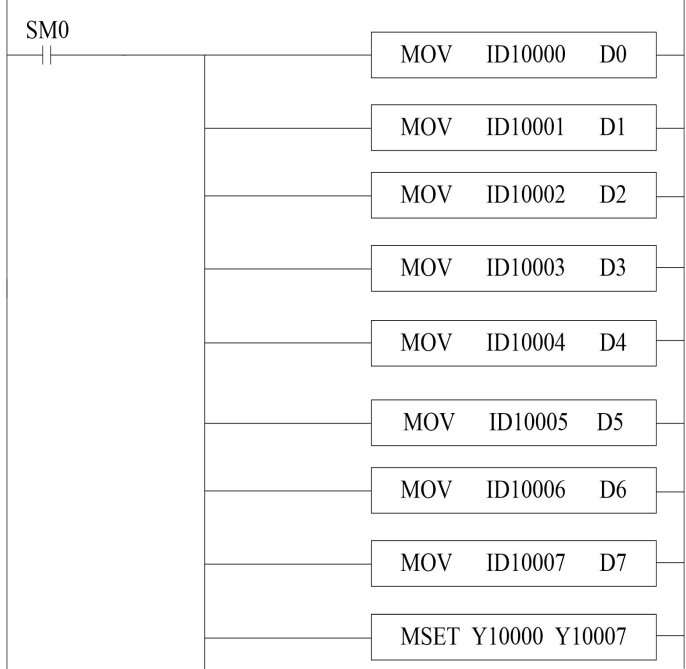

Explanation:

SM0 is always ON coil.

PLC is running. PLC keeps on writing channel 0 data to D0, channel 1 data to D1, channel 2 data to D2, channel 3 data to D3, channel 4 data to D4, channel 5 data to D5, channel 6 data to D6, channel 7 data to D7. Set ON all the channels enable bits.

7. Analog input module XD-E8AD-V

7-1. Specification

XD-E8AD-V transform the analog value (voltage input) to digital value and send to PLC registers.

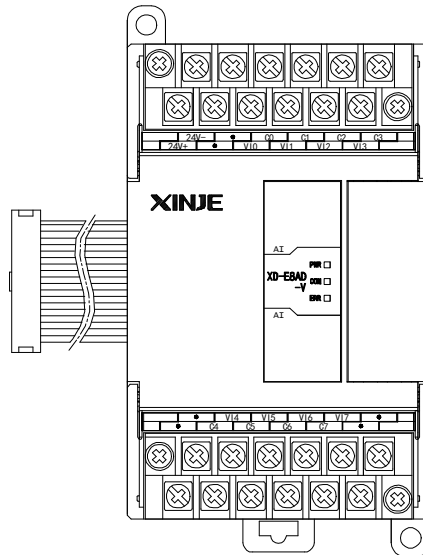

Features:

- 8-channel analog input: voltage input.
- 14-bit high precision analog input.
- As a special function module of XD series, XD3/XD3E can connect up to 10 modules on the right side of PLC main unit, XD5/XDM/XDC/XD5E/XDME/XDH can expand 16 modules, XD1/XD2 does not support expansion modules.

Specifications:

Items	Voltage input
Analog input range	0~5V, 0~10V, -10~10V, -5~5V (impedance > 1M)
Max input range	DC ± 15V
Digital output range	14 bits binary data (0~16383 or -8192~8191)
Resolution	1/16383(14Bit)
Integrate Precision	± 1%
Conversion speed	2ms per channel
Analog power supply	DC24V±10%,150mA
Installation	Can be fixed with screw M3 or directly installed on orbit of DIN46277 (width: 35mm)
Dimension	63mm×108mm×89.9mm

7-2. Terminals

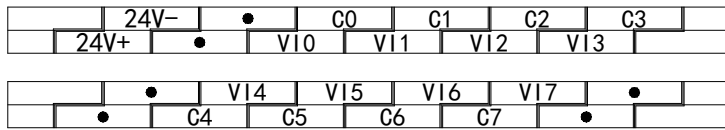

Channel	Terminal name	Signal name
CH0	VI0	voltage input
	C0	CH0 analog input common terminal
CH1	VI1	voltage input
	C1	CH1 analog input common terminal
CH2	VI2	voltage input
	C2	CH2 analog input common terminal
CH3	VI3	voltage input
	C3	CH3 analog input common terminal
CH4	VI4	voltage input
	C4	CH4 analog input common terminal
CH5	VI5	voltage input
	C5	CH5 analog input common terminal
CH6	VI6	voltage input
	C6	CH6 analog input common terminal
CH7	VI7	voltage input
	C7	CH7 analog input common terminal
-	24V+	+24V power supply
	24V-	Common terminal of power supply

7-3. I/O distribution

XD series analog expansion modules don't occupy I/O unit; the converted data is directly transferred to PLC register. Each channel address:

Note: each channel can only be used when the enable bit is turned on.

I/O address list

Register address of expansion module 1:

Channel	AD signal	Channel enable (set ON the enable bit to use this channel)	Channel alarm bit
0CH	ID10000	Y10000	X10000
1CH	ID10001	Y10001	X10001
2CH	ID10002	Y10002	X10002
3CH	ID10003	Y10003	X10003
4CH	ID10004	Y10004	X10004
5CH	ID10005	Y10005	X10005
6CH	ID10006	Y10006	X10006
7CH	ID10007	Y10007	X10007

Register address of expansion module 2:

Channel	AD signal	Channel enable (set ON the enable bit to use this channel)	Channel alarm bit
0CH	ID10100	Y10100	X10100
1CH	ID10101	Y10101	X10101
2CH	ID10102	Y10102	X10102
3CH	ID10103	Y10103	X10103
4CH	ID10104	Y10104	X10104
5CH	ID10105	Y10105	X10105
6CH	ID10106	Y10106	X10106
7CH	ID10107	Y10107	X10107

Register address of expansion module 3:

Channel	AD signal	Channel enable (set ON the enable bit to use this channel)	Channel alarm bit
0CH	ID10200	Y10200	X10200
1CH	ID10201	Y10201	X10201
2CH	ID10202	Y10202	X10202
3CH	ID10203	Y10203	X10203
4CH	ID10204	Y10204	X10204
5CH	ID10205	Y10205	X10205
6CH	ID10206	Y10206	X10206
7CH	ID10207	Y10207	X10207

Register address of expansion module 4:

Channel	AD signal	Channel enable (set ON the enable bit to use this channel)	Channel alarm bit
0CH	ID10300	Y10300	X10300
1CH	ID10301	Y10301	X10301
2CH	ID10302	Y10302	X10302
3CH	ID10303	Y10303	X10303
4CH	ID10304	Y10304	X10304
5CH	ID10305	Y10305	X10305
6CH	ID10306	Y10306	X10306
7CH	ID10307	Y10307	X10307

Register address of expansion module 5:

Channel	AD signal	Channel enable (set ON the enable bit to use this channel)	Channel alarm bit
0CH	ID10400	Y10400	X10400
1CH	ID10401	Y10401	X10401
2CH	ID10402	Y10402	X10402
3CH	ID10403	Y10403	X10403
4CH	ID10404	Y10404	X10404
5CH	ID10405	Y10405	X10405
6CH	ID10406	Y10406	X10406
7CH	ID10407	Y10407	X10407

Register address of expansion module 6:

Channel	AD signal	Channel enable (set ON the enable bit to use this channel)	Channel alarm bit
0CH	ID10500	Y10500	X10500
1CH	ID10501	Y10501	X10501
2CH	ID10502	Y10502	X10502
3CH	ID10503	Y10503	X10503
4CH	ID10504	Y10504	X10504
5CH	ID10505	Y10505	X10505
6CH	ID10506	Y10506	X10506

7CH	ID10507	Y10507	X10507
-----	---------	--------	--------

Register address of expansion module 7:

Channel	AD signal	Channel enable (set ON the enable bit to use this channel)	Channel alarm bit
0CH	ID10600	Y10600	X10600
1CH	ID10601	Y10601	X10601
2CH	ID10602	Y10602	X10602
3CH	ID10603	Y10603	X10603
4CH	ID10604	Y10604	X10604
5CH	ID10605	Y10605	X10605
6CH	ID10606	Y10606	X10606
7CH	ID10607	Y10607	X10607

Register address of expansion module 8:

Channel	AD signal	Channel enable (set ON the enable bit to use this channel)	Channel alarm bit
0CH	ID10700	Y10700	X10700
1CH	ID10701	Y10701	X10701
2CH	ID10702	Y10702	X10702
3CH	ID10703	Y10703	X10703
4CH	ID10704	Y10704	X10704
5CH	ID10705	Y10705	X10705
6CH	ID10706	Y10706	X10706
7CH	ID10707	Y10707	X10707

Register address of expansion module 9:

Channel	AD signal	Channel enable (set ON the enable bit to use this channel)	Channel alarm bit
0CH	ID10800	Y11000	X11000
1CH	ID10801	Y11001	X11001
2CH	ID10802	Y11002	X11002
3CH	ID10803	Y11003	X11003
4CH	ID10804	Y11004	X11004
5CH	ID10805	Y11005	X11005

6CH	ID10806	Y11006	X11006
7CH	ID10807	Y11007	X11007

Register address of expansion module 10:

Channel	AD signal	Channel enable (set ON the enable bit to use this channel)	Channel alarm bit
0CH	ID10900	Y11100	X11100
1CH	ID10901	Y11101	X11101
2CH	ID10902	Y11102	X11102
3CH	ID10903	Y11103	X11103
4CH	ID10904	Y11104	X11104
5CH	ID10905	Y11105	X11105
6CH	ID10906	Y11106	X11106
7CH	ID10907	Y11107	X11107

Register address of expansion module 11:

Channel	AD signal	Channel enable (set ON the enable bit to use this channel)	Channel alarm bit
0CH	ID11000	Y11200	X11200
1CH	ID11001	Y11201	X11201
2CH	ID11002	Y11202	X11202
3CH	ID11003	Y11203	X11203
4CH	ID11004	Y11204	X11204
5CH	ID11005	Y11205	X11205
6CH	ID11006	Y11206	X11206
7CH	ID11007	Y11207	X11207

Register address of expansion module 12:

Channel	AD signal	Channel enable (set ON the enable bit to use this channel)	Channel alarm bit
0CH	ID11100	Y11300	X11300
1CH	ID11101	Y11301	X11301
2CH	ID11102	Y11302	X11302
3CH	ID11103	Y11303	X11303
4CH	ID11104	Y11304	X11304

5CH	ID11105	Y11305	X11305
6CH	ID11106	Y11306	X11306
7CH	ID11107	Y11307	X11307

Register address of expansion module 13:

Channel	AD signal	Channel enable (set ON the enable bit to use this channel)	Channel alarm bit
0CH	ID11200	Y11400	X11400
1CH	ID11201	Y11401	X11401
2CH	ID11202	Y11402	X11402
3CH	ID11203	Y11403	X11403
4CH	ID11204	Y11404	X11404
5CH	ID11205	Y11405	X11405
6CH	ID11206	Y11406	X11406
7CH	ID11207	Y11407	X11407

Register address of expansion module 14:

Channel	AD signal	Channel enable (set ON the enable bit to use this channel)	Channel alarm bit
0CH	ID11300	Y11500	X11500
1CH	ID11301	Y11501	X11501
2CH	ID11302	Y11502	X11502
3CH	ID11303	Y11503	X11503
4CH	ID11304	Y11504	X11504
5CH	ID11305	Y11505	X11505
6CH	ID11306	Y11506	X11506
7CH	ID11307	Y11507	X11507

Register address of expansion module 15:

Channel	AD signal	Channel enable (set ON the enable bit to use this channel)	Channel alarm bit
0CH	ID11400	Y11600	X11600
1CH	ID11401	Y11601	X11601
2CH	ID11402	Y11602	X11602
3CH	ID11403	Y11603	X11603
4CH	ID11404	Y11604	X11604
5CH	ID11405	Y11605	X11605
6CH	ID11406	Y11606	X11606
7CH	ID11407	Y11607	X11607

Register address of expansion module 16:

Channel	AD signal	Channel enable (set ON the enable bit to use this channel)	Channel alarm bit
0CH	ID11500	Y11700	X11700
1CH	ID11501	Y11701	X11701
2CH	ID11502	Y11702	X11702
3CH	ID11503	Y11703	X11703
4CH	ID11504	Y11704	X11704
5CH	ID11505	Y11705	X11705
6CH	ID11506	Y11706	X11706
7CH	ID11507	Y11707	X11707

Note:

1. Forbid the unused channel to improve the I/O scanning speed.
2. If set off the enable bit of the channel, this channel will not accept the data. (the data display is 0).

7-4. Working mode

There are two ways to set the working mode:

1. XDPpro software
2. Flash registers of PLC

XDPpro software:

Open the XDPpro software, click configure/expansion module settings:

Set the model and channel parameters in the following window. Then click write to PLC.

Please restart the PLC after setting.

Note:

1. The first-order low-pass filtering method uses this sampling value and the last filtering output value for weighting to get the effective filtering value.

2. The filter coefficient is set to 0 ~ 254 by the user, the smaller the value is, the more stable the data is, but it may cause data lag; when it is set to 1, the filtering effect is the strongest, and when it is set to 254, the filtering effect is the weakest, and the default value is 0 (no filtering).

3. When the module flag bit Short circuit / circuit breakage / supe... open is set on, please monitor X but not Y, as Y is channel enable bit.

For example, AD channel 1 is voltage mode, AD detection is over range, X10000 will be ON.

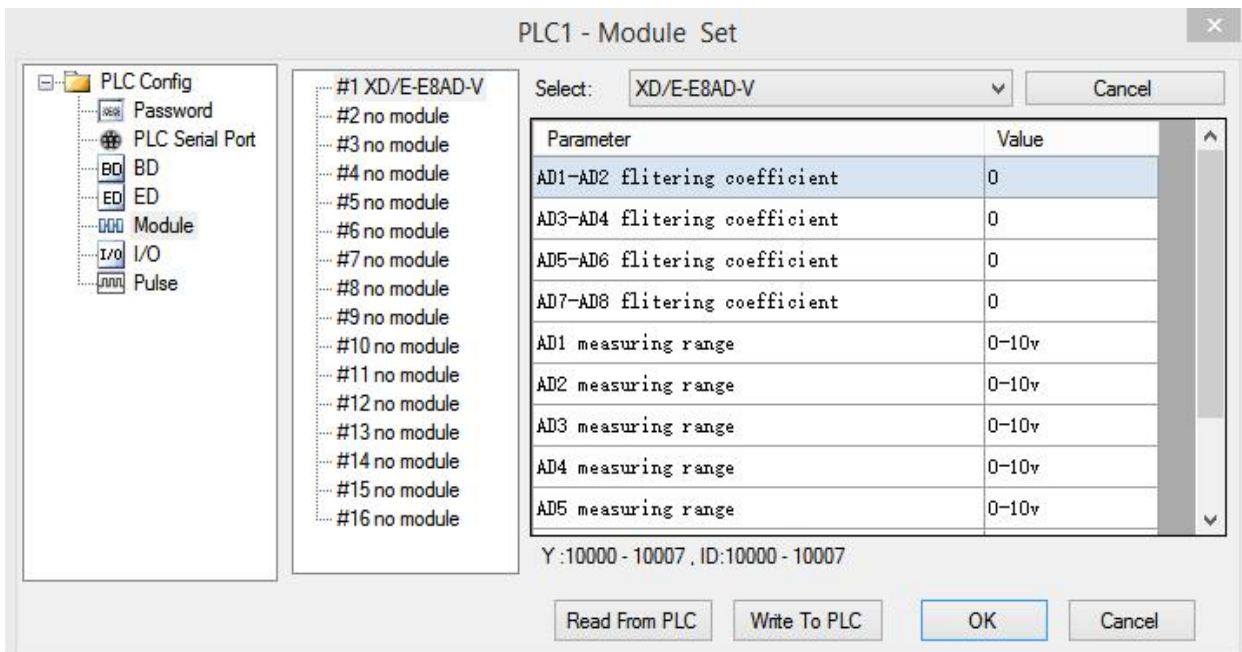

Flash registers:

The module is voltage input mode, the voltage range include 0~10V, 0~5V, -10~10V, -5~5V. Set the modes through SFD registers of PLC. See the following table:

Module no.	SFD address	Module no.	SFD address
#1	SFD350~SFD359	#9	SFD430~SFD439
#2	SFD360~SFD369	#10	SFD440~SFD449
#3	SFD370~SFD379	#11	SFD450~SFD459

#4	SFD380~SFD389	#12	SFD460~SFD469
#5	SFD390~SFD399	#13	SFD470~SFD479
#6	SFD400~SFD409	#14	SFD480~SFD489
#7	SFD410~SFD419	#15	SFD490~SFD499
#8	SFD420~SFD429	#16	SFD500~SFD509

Note: each SFD register can set 4 channels mode. Each register has 16 bits, every 4 bits set one channel mode.

SFD bit definition:

Register	Bit7	Bit6	Bit5	Bit4	Bit3	Bit2	Bit1	Bit0	Note	
SFD350	Byte0	AD channel 2, 1 filtering coefficient							AD filtering coefficient	
	Byte1	AD channel 4, 3 filtering coefficient								
SFD351	Byte2	AD channel 6, 5 filtering coefficient								
	Byte3	AD channel 8, 7 filtering coefficient								
SFD352	Byte4	Bit7	Bit6	Bit5	Bit4	Bit3	Bit2	Bit1	Bit0	To define the AD input range. Byte4 low 4 bits set channel 1 mode, high 4 bits set channel 2 mode. Byte5 low 4 bits set channel 3 mode, high 4 bits set channel 4 mode. Byte6 low 4 bits set channel 5 mode, high 4 bits set channel 6 mode. Byte7 low 4 bits set channel 7 mode, high 4 bits set channel 8 mode.
		AD2				AD1				
		0000: 0~10V 0001: 0~5V 0010: -10~10V 0011: -5~5V				0000: 0~10V 0001: 0~5V 0010: -10~10V 0011: -5~5V				
	Byte5	Bit7	Bit6	Bit5	Bit4	Bit3	Bit2	Bit1	Bit0	
		AD4				AD3				
0000: 0~10V 0001: 0~5V 0010: -10~10V 0011: -5~5V				0000: 0~10V 0001: 0~5V 0010: -10~10V 0011: -5~5V						
SFD353	Byte6	Bit7	Bit6	Bit5	Bit4	Bit3	Bit2	Bit1	Bit0	
		AD6				AD5				
		0000: 0~10V 0001: 0~5V 0010: -10~10V 0011: -5~5V				0000: 0~10V 0001: 0~5V 0010: -10~10V 0011: -5~5V				
	Byte7	Bit7	Bit6	Bit5	Bit4	Bit3	Bit2	Bit1	Bit0	
		AD8				AD7				

		0000: 0~10V 0001: 0~5V 0010: -10~10V 0011: -5~5V	0000: 0~10V 0001: 0~5V 0010: -10~10V 0011: -5~5V	
SFD354	Byte8	AD channel short circuit/open circuit/over range detection switch		
	Byte9	-		
SFD355~SFD359		-		

For example: set module no.1 channel 1 and channel 0 mode to 0~10V. Set channel 3 and channel 2 mode to 0~5V. Set channel 5 and channel 4 mode to -5~5V. Set channel 7 and channel 6 mode to -10~10V. The filter factor of channel 0 to channel 3 is 255. The filter factor of channel 4 to channel 7 is 100. Then the SFD350=FFFFH SFD351=6464H SFD352=1100H SFD353=2233H

7-5. Exterior connection

Notes:

- When connect external +24V power, please use the 24V power of PLC to avoid interference.
- To avoid interference, please use shield cable and single point ground for the shield layer.

Voltage input:

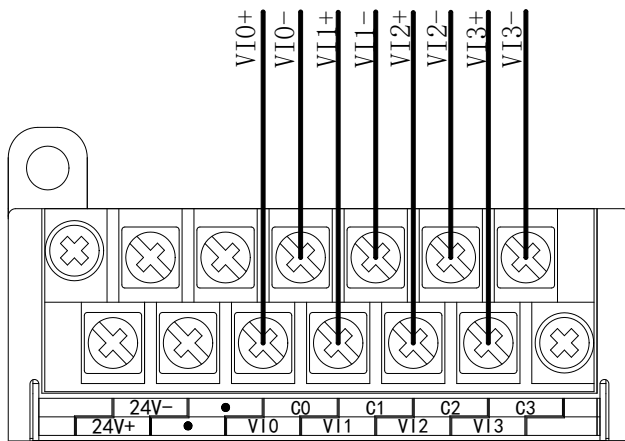

7-6. AD conversion diagram

The relationship between analog value and digital value is shown as the following diagram:

0~10V voltage input	0~5V voltage input
-10~10V voltage input	-5~5V voltage input

7-7. Program application

Real-time read the data of the 8 channels (module no.1)

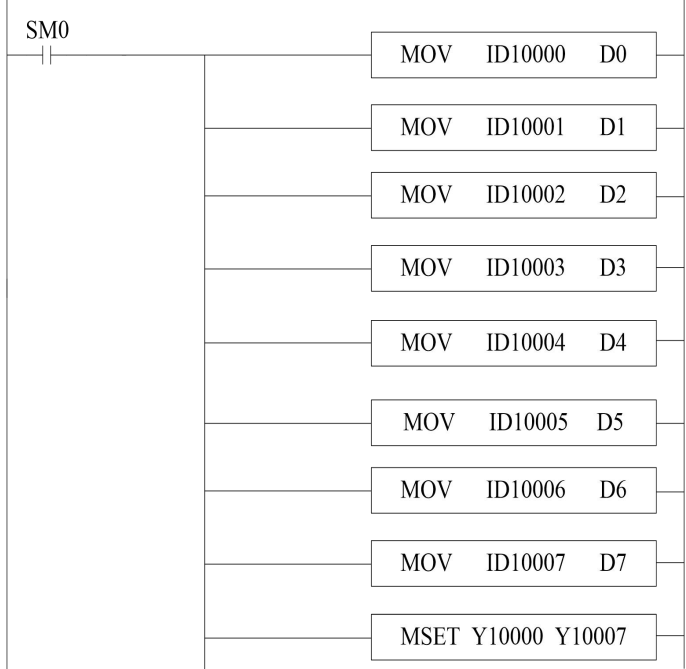

Explanation:

SM0 is always ON coil.

PLC is running. PLC keeps on writing channel 0 data to D0, channel 1 data to D1, channel 2 data to D2, channel 3 data to D3, channel 4 data to D4, channel 5 data to D5, channel 6 data to D6, channel 7 data to D7. Set ON all the channels enable bits.

8. Analog output module XD-E2DA

8-1. Specifications

XD-E2DA transforms 2 channels of 12 bits digital value to current or voltage output.

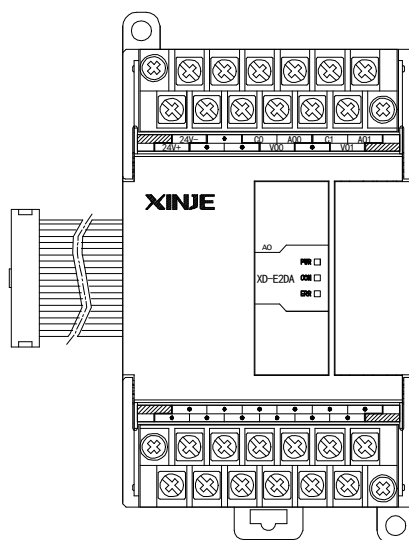

Features:

- 2-channel analog output.
- As a special function module of XD series, XD3/XD3E can connect up to 10 modules on the right side of PLC main unit, XD5/XDM/XDC/XD5E/XDME/XD3E can expand 16 modules, XD1/XD2 does not support expansion modules.

Specifications:

Items	Voltage output	Current output
Analog output	0~5V, 0~10V, -5~5V, -10~10V (external load resistor 2K Ω ~1M Ω)	0~20mA, 4~20mA (external load resistor is less than 500 Ω)
Digital input	12 bits binary value (0~4095 or -2048~2047)	
Resolution	1/4095(12 bit)	
General precision	$\pm 1\%$	
Conversion speed	2ms per channel	
Power supply for analog using	DC24V $\pm 10\%$,150mA	
Installation	Fix with M3 screws or install on DIN46277 (width: 35mm) leader directly	
Dimension	63mm \times 108mm \times 89.9mm	

Note: XD-E2DA module below version V7 does not support -5 ~ 5V and -10 ~ 10V.

8-2. Terminals

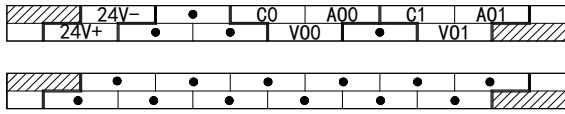

Channel	Terminal name	Signal name
CH0	A00	Current output
	V00	Voltage output
	C0	CH0 common terminal
CH1	A01	Current output
	V01	Voltage output
	C1	CH1 common terminal
-	24V+	+24V power supply
	24V-	Common terminal of power supply

8-3. I/O address assignment

XD series analog modules don't occupy I/O units; the converted value is sent to PLC register directly. The PLC registers are shown as the following:

Note: each channel can only be used when the enable bit is turned on.

Expansion module no.1

Channel	DA signal	Channel enable bit (set on this bit to use this channel)
0CH	QD10000	Y10000
1CH	QD10001	Y10001

Expansion module no.2

Channel	DA signal	Channel enable bit (set on this bit to use this channel)
0CH	QD10100	Y10100
1CH	QD10101	Y10101

Expansion module no.3

Channel	DA signal	Channel enable bit (set on this bit to use this channel)
0CH	QD10200	Y10200
1CH	QD10201	Y10201

Expansion module no.4

Channel	DA signal	Channel enable bit (set on this bit to use this channel)
0CH	QD10300	Y10300
1CH	QD10301	Y10301

Expansion module no.5

Channel	DA signal	Channel enable bit (set on this bit to use this channel)
0CH	QD10400	Y10400
1CH	QD10401	Y10401

Expansion module no.6

Channel	DA signal	Channel enable bit (set on this bit to use this channel)
0CH	QD10500	Y10500
1CH	QD10501	Y10501

Expansion module no.7

Channel	DA signal	Channel enable bit (set on this bit to use this channel)
0CH	QD10600	Y10600
1CH	QD10601	Y10601

Expansion module no.8

Channel	DA signal	Channel enable bit (set on this bit to use this channel)
0CH	QD10700	Y10700
1CH	QD10701	Y10701

Expansion module no.9

Channel	DA signal	Channel enable bit (set on this bit to use this channel)
0CH	QD10800	Y11000
1CH	QD10801	Y11001

Expansion module no.10

Channel	DA signal	Channel enable bit (set on this bit to use this channel)
0CH	QD10900	Y11100
1CH	QD10901	Y11101

Expansion module no.11

Channel	DA signal	Channel enable bit (set on this bit to use this channel)
0CH	QD11000	Y11200
1CH	QD11001	Y11201

Expansion module no.12

Channel	DA signal	Channel enable bit (set on this bit to use this channel)
0CH	QD11100	Y11300
1CH	QD11101	Y11301

Expansion module no.13

Channel	DA signal	Channel enable bit (set on this bit to use this channel)
0CH	QD11200	Y11400
1CH	QD11201	Y11401

Expansion module no.14

Channel	DA signal	Channel enable bit (set on this bit to use this channel)
0CH	QD11300	Y11500
1CH	QD11301	Y11501

Expansion module no.15

Channel	DA signal	Channel enable bit (set on this bit to use this channel)
0CH	QD11400	Y11600
1CH	QD11401	Y11601

Expansion module no.16

Channel	DA signal	Channel enable bit (set on this bit to use this channel)
0CH	QD11500	Y11700
1CH	QD11501	Y11701

Note:

1. Forbid the unused channel to improve the I/O scanning speed.
2. If set off the enable bit of the output channel, this channel will keep the present value.

8-4. Working mode

There are two ways to set the working mode:

1. XDPpro software
2. Flash registers of PLC

XDPpro software:

Open the XDPpro software, click configure/expansion module settings:

Set the model and channel parameters in the following window. Then click write to PLC.

Please restart the PLC after setting.

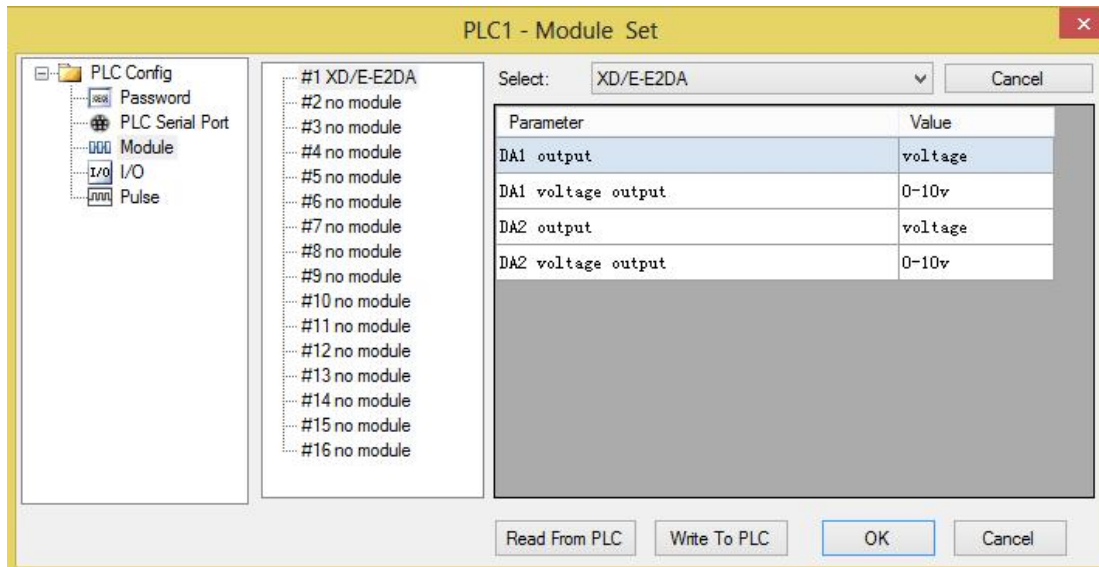

Flash registers:

The module output has voltage 0 ~ 5V, 0 ~ 10V, -5~5V, -10~10V; current 0 ~ 20mA, 4 ~ 20mA, set the modes through the PLC FLASH registers SFD.

Module no.	SFD address	Module no.	SFD address
#1	SFD350~SFD359	#9	SFD430~SFD439
#2	SFD360~SFD369	#10	SFD440~SFD449
#3	SFD370~SFD379	#11	SFD450~SFD459
#4	SFD380~SFD389	#12	SFD460~SFD469
#5	SFD390~SFD399	#13	SFD470~SFD479
#6	SFD400~SFD409	#14	SFD480~SFD489
#7	SFD410~SFD419	#15	SFD490~SFD499
#8	SFD420~SFD429	#16	SFD500~SFD509

SFD bit definition:

Expansion module no.1:

Register		Bit7	Bit6	Bit5	Bit4	Bit3	Bit2	Bit1	Bit0	Note
SFD350	Byte0	DA2				DA1				To define the DA output range. Byte0 low 4 bits are DA channel 1, high 4 bits are DA channel 2.
		-	000: 0~10V 001: 0~5V 100: -10~10V 101: -5~5V 010: 0~20mA 011: 4~20mA			-	000: 0~10V 001: 0~5V 100: -10~10V 101: -5~5V 010: 0~20mA 011: 4~20mA			
	Byte1	-								
SFD351~SFD359		-								

For example:

Set channel 1 and channel 0 working mode to 0~10V, 0~20mA.

The SFD values are: SFD350=2H.

8-5. External connection

When make external connection, please note the following items:

- When connect to external +24V power supply, please use 24V power supply of PLC to avoid interference.
- To avoid interference, please use shield cable, and single-point ground with the shield layer.

Voltage output:

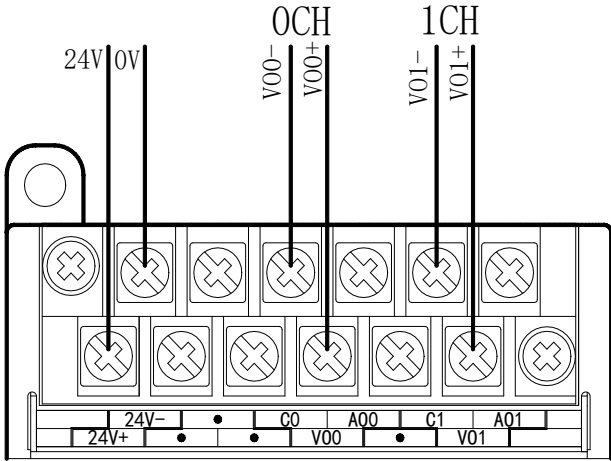

Current output:

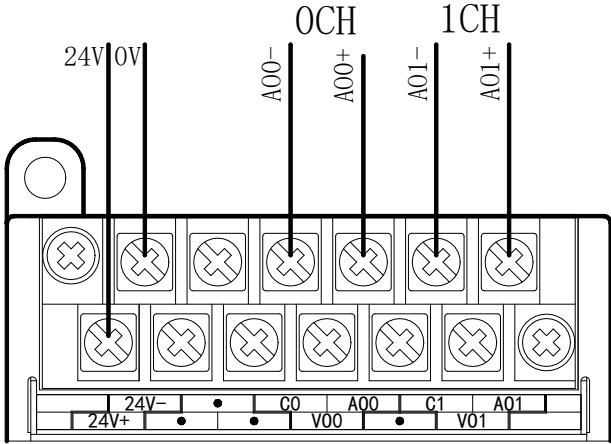

XD-E2DA current output wiring:

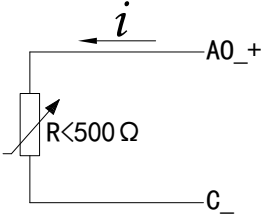

8-6. DA conversion diagram

The relationship between digital input value and analog output value is shown as below:

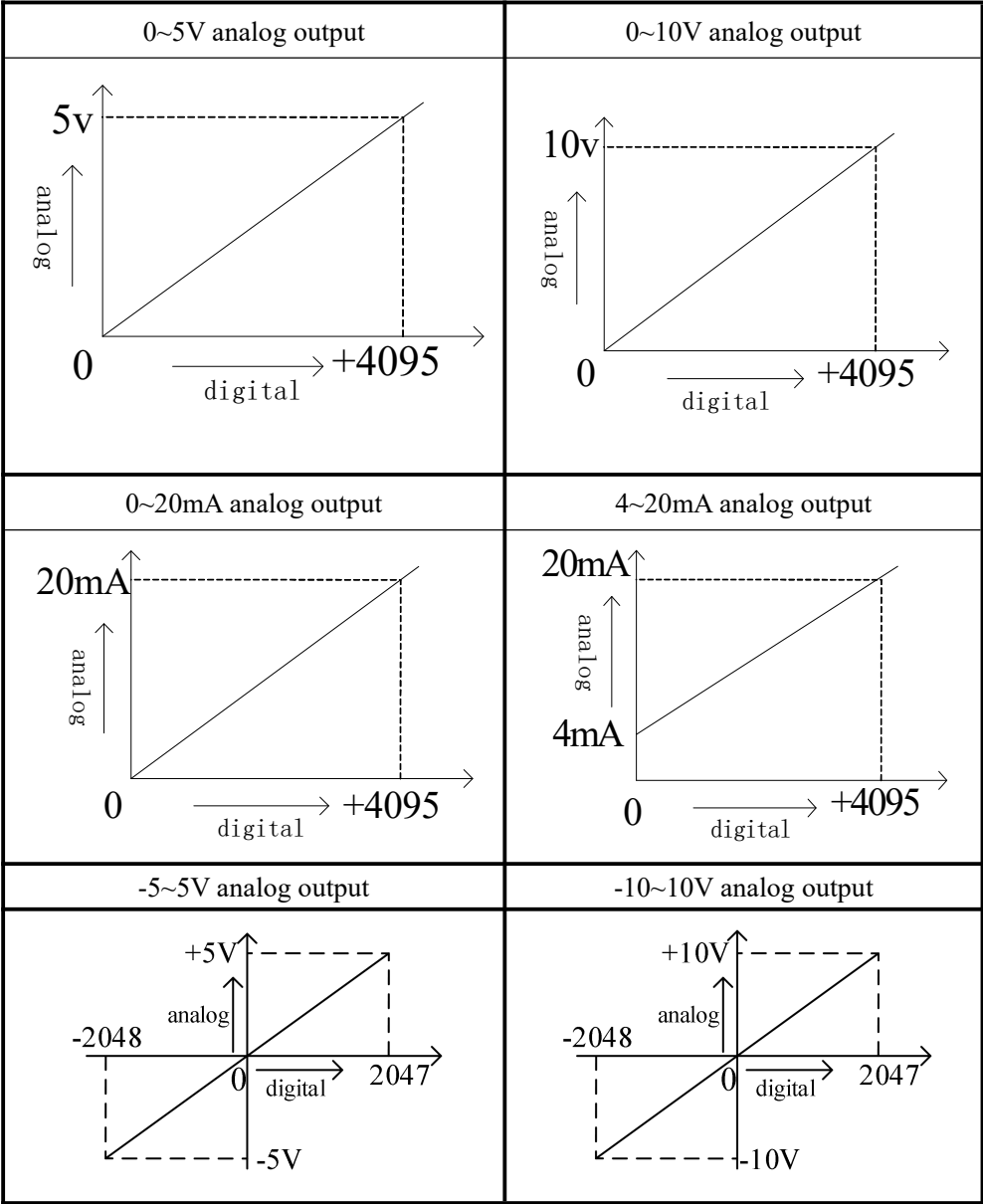

Note: when the input data exceeds K4095, the output analog data of D/A conversion remains unchanged at 5V, 10V or 20mA.

8-7. Programming

Real-time write data to 2 channels (take expansion module no.1 as an example)

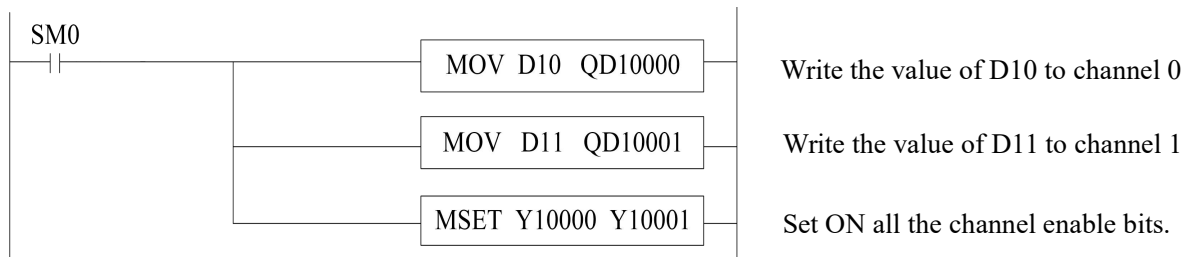

9. Analog output module XD-E4DA

9-1. Specifications

XD-E4DA module transforms 4 channels digital value to analog value and send the data to PLC.

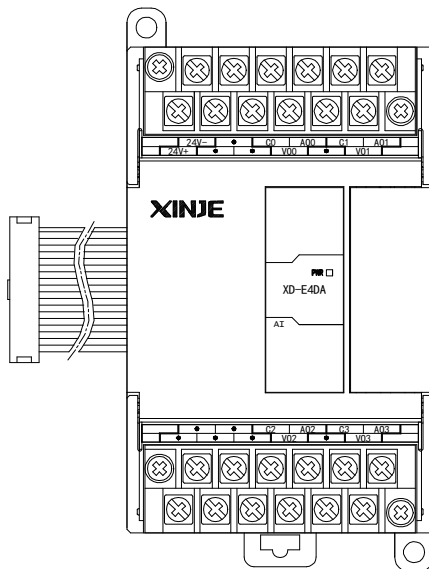

Features:

- 4-channel analog output: voltage output or current output.
- As a special function module of XD series, XD3/XD3E can connect up to 10 modules on the right side of PLC main unit, XD5/XDM/XDC/XD5E/XDME/XDH can expand 16 modules, XD1/XD2 does not support expansion modules.

Specifications:

Items	Voltage output	Current output
Analog output	DC 0 to 5V, 0 to 10V (external load resistor 2K Ω ~1M Ω)	DC 0 to 20mA, 4 to 20mA (external load resistor is less than 500 Ω)
Digital input	12 bits binary value (0~4095)	
Resolution	1/4095(12 bit)	
General precision	1%	

Conversion speed	2ms per channel
Power supply for analog using	DC24V±10%,150mA
Installation	Fix with M3 screws or install on DIN46277 (width: 35mm) leader directly
Dimension	63mm×108mm×89.9mm

9-2. Terminals

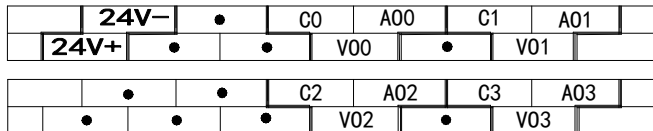

Channel	Terminal name	Signal name
CH0	AO0	Current output
	VO0	Voltage output
	C0	CH0 common terminal
CH1	AO1	Current output
	VO1	Voltage output
	C1	CH1 common terminal
CH2	AO2	Current output
	VO2	Voltage output
	C2	CH2 common terminal
CH3	AO3	Current output
	VO3	Voltage output
	C3	CH3 common terminal
-	24V+	+24V power supply
	24V-	Common terminal of power supply

9-3. I/O address assignment

XD series analog modules don't occupy I/O units; the converted value is sent to PLC register directly.

The PLC registers are shown as the following:

Note: each channel can only be used when the enable bit is turned on.

Expansion module no.1

Channel	DA signal	Channel enable bit (set on this bit to use this channel)
0CH	QD10000	Y10000
1CH	QD10001	Y10001
2CH	QD10002	Y10002
3CH	QD10003	Y10003

Expansion module no.2

Channel	DA signal	Channel enable bit (set on this bit to use this channel)
0CH	QD10100	Y10100
1CH	QD10101	Y10101
2CH	QD10102	Y10102
3CH	QD10103	Y10103

Expansion module no.3

Channel	DA signal	Channel enable bit (set on this bit to use this channel)
0CH	QD10200	Y10200
1CH	QD10201	Y10201
2CH	QD10202	Y10202
3CH	QD10203	Y10203

Expansion module no.4

Channel	DA signal	Channel enable bit (set on this bit to use this channel)
0CH	QD10300	Y10300
1CH	QD10301	Y10301
2CH	QD10302	Y10302
3CH	QD10303	Y10303

Expansion module no.5

Channel	DA signal	Channel enable bit (set on this bit to use this channel)
0CH	QD10400	Y10400
1CH	QD10401	Y10401

2CH	QD10402	Y10402
3CH	QD10403	Y10403

Expansion module no.6

Channel	DA signal	Channel enable bit (set on this bit to use this channel)
0CH	QD10500	Y10500
1CH	QD10501	Y10501
2CH	QD10502	Y10502
3CH	QD10503	Y10503

Expansion module no.7

Channel	DA signal	Channel enable bit (set on this bit to use this channel)
0CH	QD10600	Y10600
1CH	QD10601	Y10601
2CH	QD10602	Y10602
3CH	QD10603	Y10603

Expansion module no.8

Channel	DA signal	Channel enable bit (set on this bit to use this channel)
0CH	QD10700	Y10700
1CH	QD10701	Y10701
2CH	QD10702	Y10702
3CH	QD10703	Y10703

Expansion module no.9

Channel	DA signal	Channel enable bit (set on this bit to use this channel)
0CH	QD10800	Y11000
1CH	QD10801	Y11001
2CH	QD10802	Y11002
3CH	QD10803	Y11003

Expansion module no.10

Channel	DA signal	Channel enable bit (set on this bit to use this channel)
0CH	QD10900	Y11100

1CH	QD10901	Y11101
2CH	QD10902	Y11102
3CH	QD10903	Y11103

Expansion module no.11

Channel	DA signal	Channel enable bit (set on this bit to use this channel)
0CH	QD11000	Y11200
1CH	QD11001	Y11201
2CH	QD11002	Y11202
3CH	QD11003	Y11203

Expansion module no.12

Channel	DA signal	Channel enable bit (set on this bit to use this channel)
0CH	QD11100	Y11300
1CH	QD11101	Y11301
2CH	QD11102	Y11302
3CH	QD11103	Y11303

Expansion module no.13

Channel	DA signal	Channel enable bit (set on this bit to use this channel)
0CH	QD11200	Y11400
1CH	QD11201	Y11401
2CH	QD11202	Y11402
3CH	QD11203	Y11403

Expansion module no.14

Channel	DA signal	Channel enable bit (set on this bit to use this channel)
0CH	QD11300	Y11500
1CH	QD11301	Y11501
2CH	QD11302	Y11502
3CH	QD11303	Y11503

Expansion module no.15

Channel	DA signal	Channel enable bit (set on this bit to use this channel)
0CH	QD11400	Y11600
1CH	QD11401	Y11601
2CH	QD11402	Y11602
3CH	QD11403	Y11603

Expansion module no.16

Channel	DA signal	Channel enable bit (set on this bit to use this channel)
0CH	QD11500	Y11700
1CH	QD11501	Y11701
2CH	QD11502	Y11702
3CH	QD11503	Y11703

Note:

1. Forbid the unused channel to improve the I/O scanning speed.
2. If set off the enable bit of the output channel, this channel will keep the present value.

9-4. Working mode

There are two ways to set the working mode:

1. XDPpro software
2. Flash registers of PLC

XDPpro software:

Open the XDPpro software, click configure/expansion module settings:

Set the model and channel parameters in the following window. Then click write to PLC.

Please restart the PLC after setting.

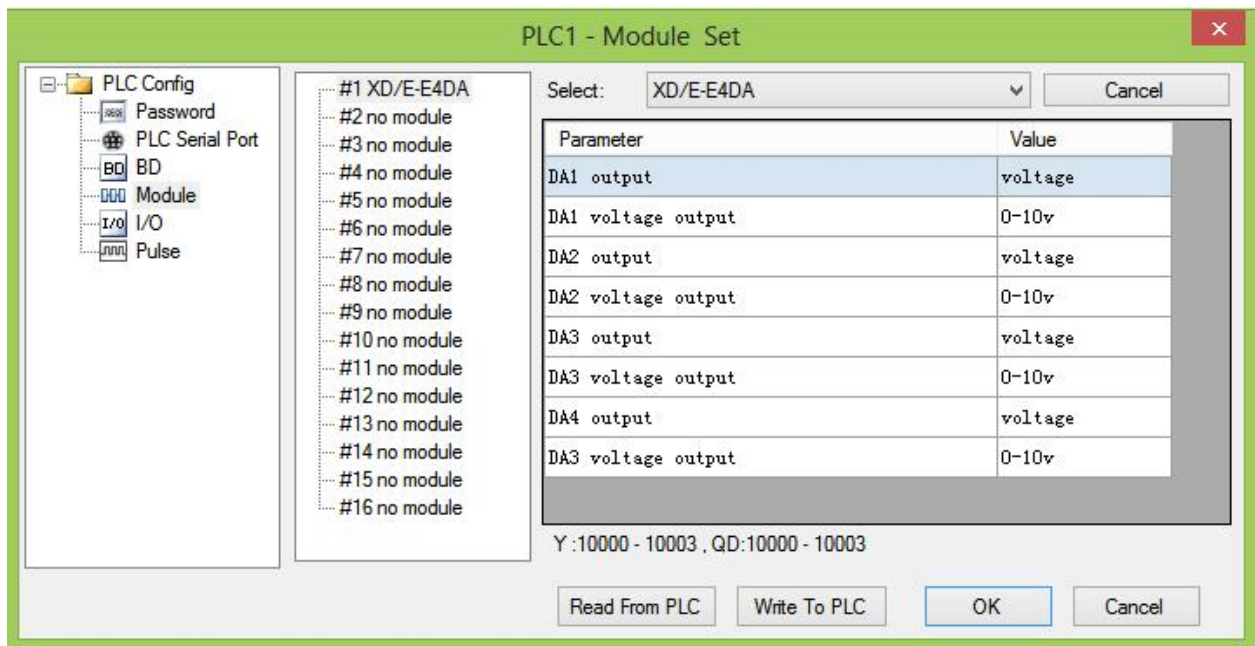

Flash registers:

The module output has voltage 0 ~ 5V, 0 ~ 10V, current 0 ~ 20mA, 4 ~ 20mA, set the modes through the PLC FLASH registers SFD.

Module no.	SFD address	Module no.	SFD address
#1	SFD350~SFD359	#9	SFD430~SFD439
#2	SFD360~SFD369	#10	SFD440~SFD449
#3	SFD370~SFD379	#11	SFD450~SFD459
#4	SFD380~SFD389	#12	SFD460~SFD469
#5	SFD390~SFD399	#13	SFD470~SFD479
#6	SFD400~SFD409	#14	SFD480~SFD489
#7	SFD410~SFD419	#15	SFD490~SFD499
#8	SFD420~SFD429	#16	SFD500~SFD509

SFD bit definition:

Expansion module no.1:

	Bit7	Bit6	Bit5	Bit4	Bit3	Bit2	Bit1	Bit0	Explanation
	DA2				DA1				To define the DA output range. Byte0 low 4 bits are DA channel 1, high 4 bits are DA channel 2. Byte1 low 4 bits are DA channel 3, high 4 bits are DA channel 4.
Byte0	-	-	0: voltage output 1: current output	0 : 0~10V 1: 0~5V 0 : 0~20mA 1 : 4~20mA	-	-	0: voltage output 1: current output	0:0~10V 1:0~5V 0:0~20mA 1:4~20mA	
	DA4				DA3				
Byte1	-	-	0: voltage output 1: current output	0 : 0~10V 1: 0~5V 0 : 0~20mA 1 : 4~20mA	-	-	0: voltage output 1: current output	0:0~10V 1:0~5V 0:0~20mA 1:4~20mA	
Byte2 ~ Byte19	-								

For example:

Set channel 4, 3, 2, 1 working mode to 0~10V, 0~10V, 0~20mA, 0~20mA.

The SFD values are: SFD350=0022H.

9-5. External connection

When make external connection, please note the following items:

- When connect to external +24V power supply, please use 24V power supply of PLC to avoid interference.
- To avoid interference, please use shield cable, and single-point ground with the shield layer.

Voltage output:

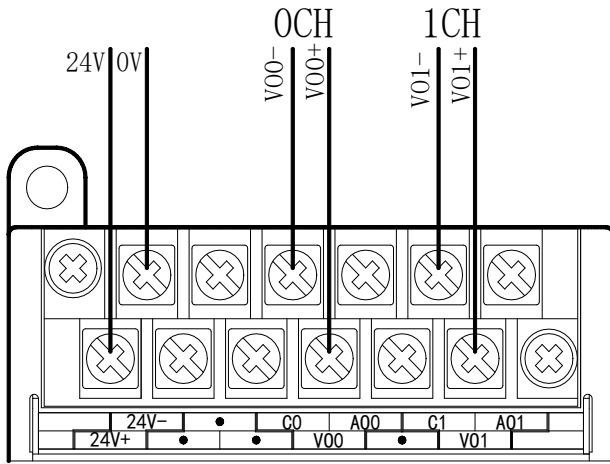

Current output:

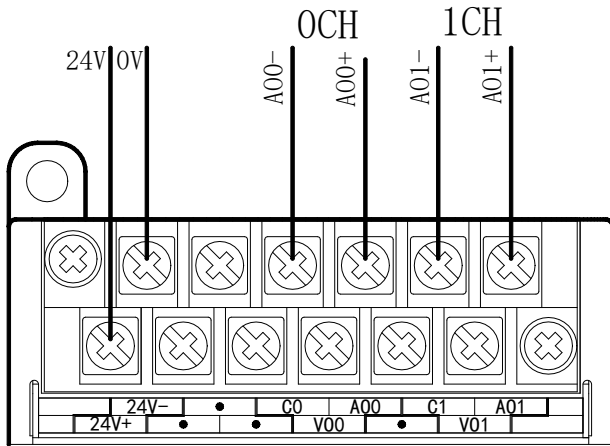

XD-E4DA current output wiring:

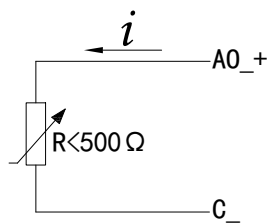

9-6. DA conversion diagram

The relationship between digital input value and analog output value is shown as below:

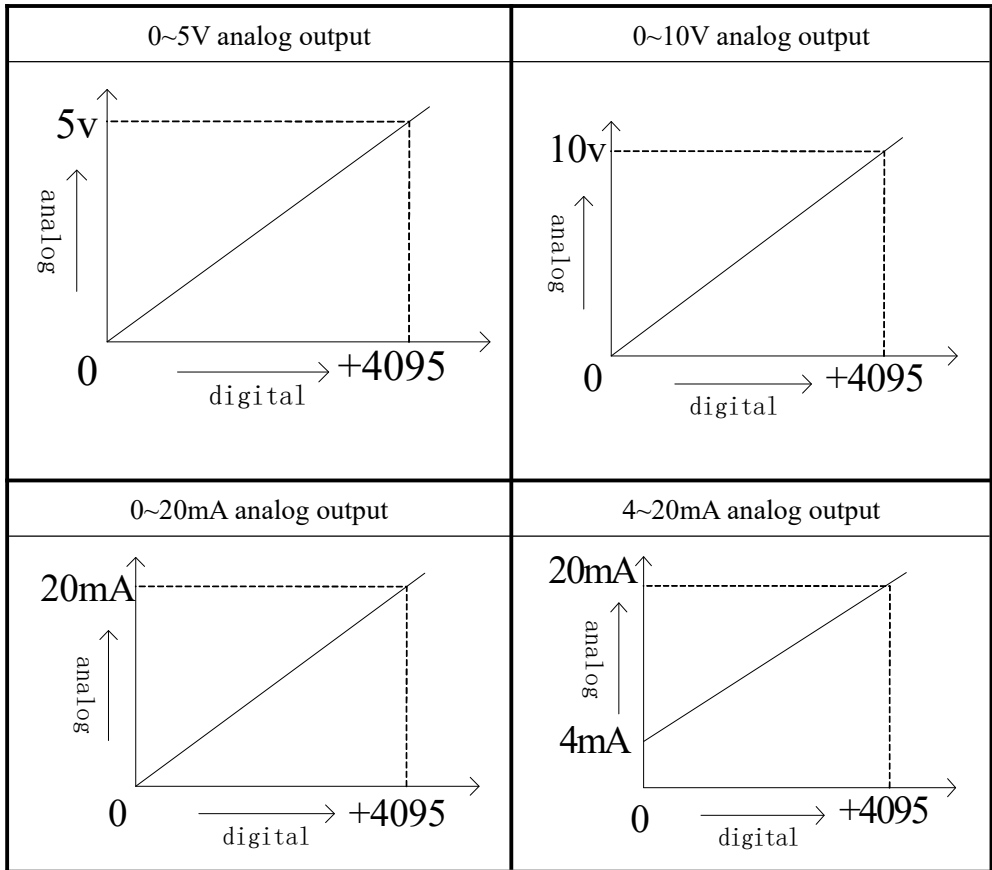

Note: when the input data exceeds K4095, the output analog data of D/A conversion remains unchanged at 5V, 10V or 20mA.

9-7. Programming

Real-time write data to 4 channels (take expansion module no.1 as an example)

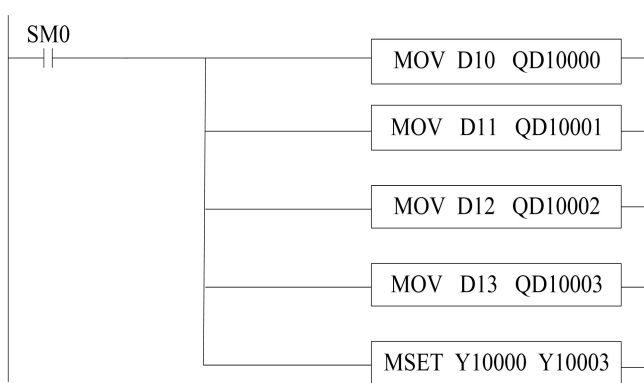

Write the value of D10 to channel 0

Write the value of D11 to channel 1

Write the value of D12 to channel 2

Write the value of D13 to channel 3

Set ON all the channel enable bits.

10. N channels pressure module XD-EnWT-A

10-1. Features

This chapter mainly introduces XD-E1WT-A, XD-E2WT-A, XD-E4WT-A module specifications, terminal description, system composition, module functions and parameters, external connections, analog-to-digital conversion diagram and related programming examples.

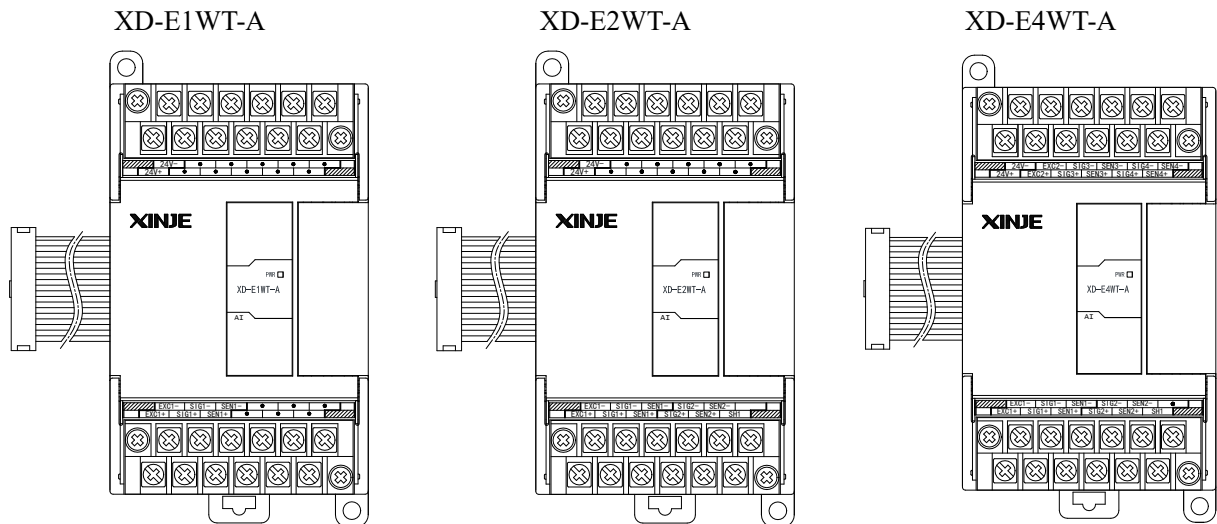

Features:

As an extension module of XD series PLC, n-channel pressure measurement module XD-EnWT-A can be used to detect voltage signal of $-39.06\text{mV}\sim 39.06\text{mV}$ or collect voltage signal of pressure sensor, and convert analog voltage value into digital value through A/D calculation.

- The analog voltage signal of 1, 2 and 4 channels pressure sensor can be collected;
- It can detect the voltage signal of $-39.06\text{ mV} \sim 39.06\text{ mV}$;
- 24-bit high precision A/D conversion;
- As a special function module of XD series, XD3/XD3E can connect up to 10 modules on the right side of PLC main unit, XD5/XDM/XDC/XD5E/XDME/XDH can expand 16 modules, XD1/XD2 does not support expansion modules.

Specifications:

Input range	DC -39.06mV~39.06mV
Resolution	1/16777216 (24Bit)
Integrated precision	±0.1%
Transformation speed	0-250 times/second
Power supply	DC24V±10%, 100mA
Sensor power supply	5VDC/120mA, can parallel 4 pieces of 350Ω pressure sensor
Installation	Mount on DIN46277 rail (width 35mm) or fix with screw M3
Working environment	No corrosive gas
Ambient temperature	0°C~60°C
Humidity	5~95%RH (no condensation)
Dimension	63mm×108mm×89.9mm
Software version	V3.2 and above

10-2. Terminals

XD-E1WT-A:

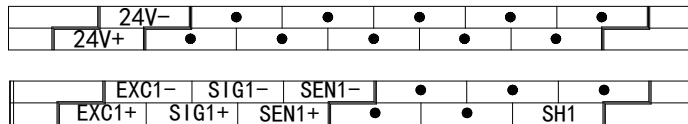

XD-E2WT-A:

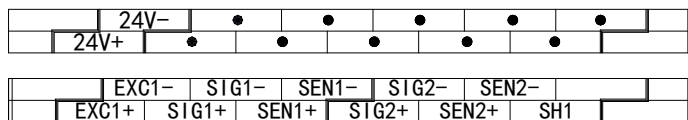

XD-E4WT-A:

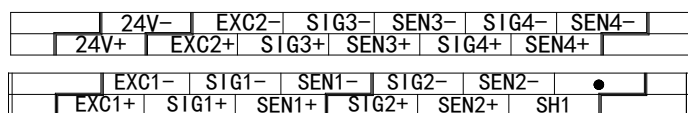

XD-E1WT-A:

Channel	Terminal	Signal	Meaning
CH1	EXC1+	Excitation +	Connect to sensor power supply input
	EXC1-	Excitation -	
	SIG1+	Signal +	Connect to sensor signal output
	SIG1-	Signal -	
	SEN1+	Feedback +	Connect to sensor feedback voltage

	SEN1-	Feedback -	output
-	SH1	Shield	Connect to sensor ground terminal
	24V+	+24V power supply	Power supply of module
	24V-	Power supply common terminal	

XD-E2WT-A:

Channel	Terminal	Signal	Meaning
CH1	EXC1+	Excitation +	Connect to sensor power supply input
	EXC1-	Excitation -	
	SIG1+	Signal +	Connect to sensor signal output
	SIG1-	Signal -	
	SEN1+	Feedback +	Connect to sensor feedback voltage output
	SEN1-	Feedback -	
CH2	EXC2+	Excitation +	Connect to sensor power supply input
	EXC2-	Excitation -	
	SIG2+	Signal +	Connect to sensor signal output
	SIG2-	Signal -	
	SEN2+	Feedback +	Connect to sensor feedback voltage output
	SEN2-	Feedback -	
-	SH1	Shield	Connect to sensor ground terminal
	24V+	+24V power supply	Power supply of module
	24V-	Power supply common terminal	

XD-E4WT-A:

Channel	Terminal	Signal	Meaning
CH1	EXC1+	Excitation +	Connect to sensor power supply input
	EXC1-	Excitation -	
	SIG1+	Signal +	Connect to sensor signal output
	SIG1-	Signal -	
	SEN1+	Feedback +	Connect to sensor feedback voltage output
	SEN1-	Feedback -	
CH2	EXC2+	Excitation +	Connect to sensor power supply input
	EXC2-	Excitation -	
	SIG2+	Signal +	Connect to sensor signal output
	SIG2-	Signal -	
	SEN2+	Feedback +	Connect to sensor feedback voltage output
	SEN2-	Feedback -	
CH3	EXC3+	Excitation +	Connect to sensor power supply input
	EXC3-	Excitation -	

	SIG3+	Signal +	Connect to sensor signal output
	SIG3-	Signal -	
	SEN3+	Feedback +	Connect to sensor feedback voltage output
	SEN3-	Feedback -	
CH4	EXC4+	Excitation +	Connect to sensor power supply input
	EXC4-	Excitation -	
	SIG4+	Signal +	Connect to sensor signal output
	SIG4-	Signal -	
	SEN4+	Feedback +	Connect to sensor feedback voltage output
	SEN4-	Feedback -	
-	SH1	Shield	Connect to sensor ground terminal
	24V+	+24V power supply	Power supply of module
	24V-	Power supply common terminal	

10-3. External connection

Please use the 24V power supply on the PLC to avoid interference.

Please use shield cable and single-point connect to the ground for shield layer.

Power supply wiring

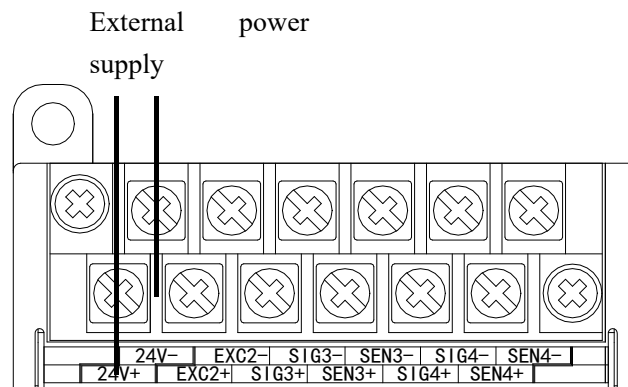

Connect to sensor

6 wires mode:

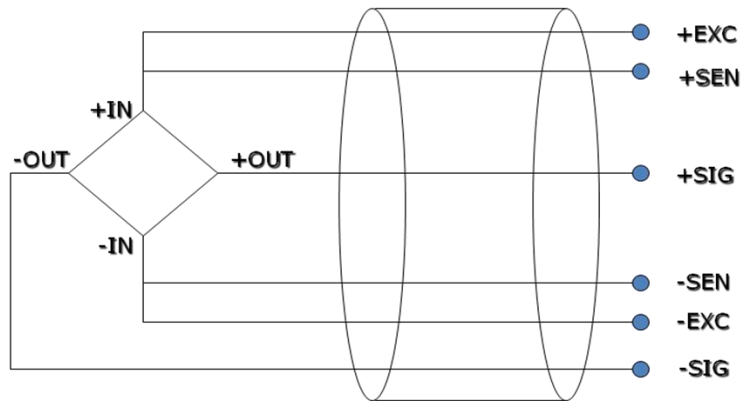

4 wires mode:

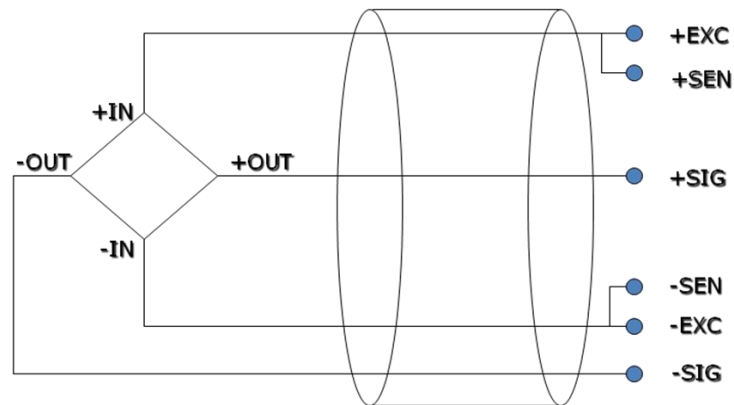

Note: short connect EXC- and SEN-, short connect EXC+ and SEN+ for 4 wires mode.

10-4. Weighing system

A typical weighing system:

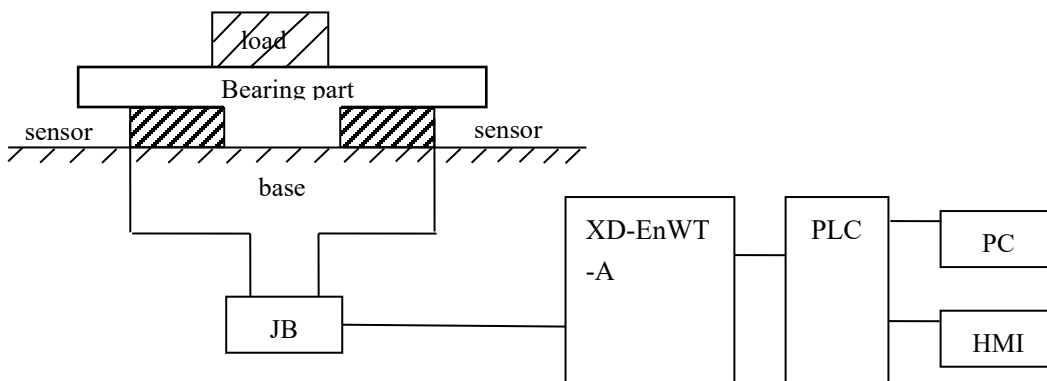

Loading bearing part: to support the load. Such as flat, hopper, container, air transport car...

Pressure sensor: transform the weight to voltage signal.

Assembly part: make sure the pressure sensor can work correctly, assembly part and direct part can avoid overload. Overload will cause measurement error and sensor damage.

Connection box (JB): to collect several sensor signals.

XD-EnWT-A: can be used as an electronic assessment device, it gets the pressure sensor signal and makes further assessment.

10-5. Module functions

XD-EnWT-A has the follow functions:

- Adjust the pressure sensor
- Collect the pressure sensor signal
- Calculate the weight value
- -39.06mV~39.06mV voltage signal detection

10-5-1. Pressure sensor

The pressure sensor is based on resistance strain effect, see the following diagram:

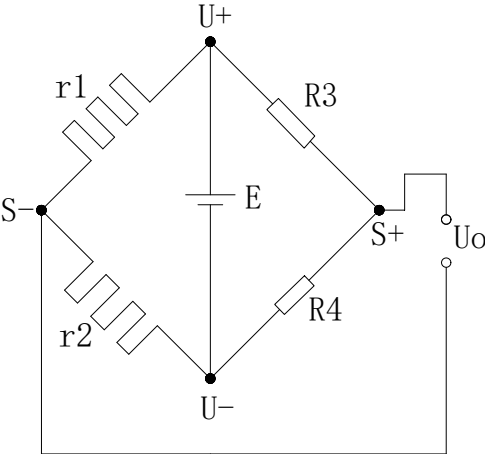

R1 and R2 is strain resistor which make bridge circuit with R3 and R4. With the change of R1 and R2, the bridge circuit will lose the balance, unbalance voltage U_o will be produced as the output of sensor.

U_+ and U_- are positive and negative point of the sensor power supply. Please select the 5V power of the module or from outside.

S_+ and S_- are positive and negative point of the sensor output. Connect the output to the module to test the weight.

10-6. I/O address

The I/O address of module 1:

Soft component		Address	Explanation	Mark
	CH1	Y10000	Fast sampling enable, ON is fast sampling, OFF is slow sampling	
		Y10001	Write in user-defined parameter	
		Y10002	Reset	

Output coil	CH2	Y10003	Calibration/resonance measurement		
		Y10004	Fast sampling enable, ON is fast sampling, OFF is slow sampling		
		Y10005	Write in user-defined parameter		
		Y10006	Reset		
		Y10007	Calibration/resonance measurement		
		CH3	Y10010	Fast sampling enable, ON is fast sampling, OFF is slow sampling	
			Y10011	Write in user-defined parameter	
	Y10012		Reset		
	CH4	Y10013	Calibration/resonance measurement		
		Y10014	Fast sampling enable, ON is fast sampling, OFF is slow sampling		
		Y10015	Write in user-defined parameter		
		Y10016	Reset		
		Y10017	Calibration/resonance measurement		
Input coil	CH1	X10000	CH1 resonance frequency measurement complete sign		
	CH2	X10001	CH2 resonance frequency measurement complete sign		
	CH3	X10002	CH3 resonance frequency measurement complete sign		
	CH4	X10003	CH4 resonance frequency measurement complete sign		
Input register	CH1	ID10000	Present digital value	Dword	
		ID10002	Present weight	Dword	
	CH2	ID10004	Present digital value	Dword	
		ID10006	Present weight	Dword	
	CH3	ID10008	Present digital value	Dword	
		ID10010	Present weight	Dword	
	CH4	ID10012	Present digital value	Dword	
		ID10014	Present weight	Dword	

The I/O address of module 2:

Soft component		Address	Explanation	Mark
Output coil	CH1	Y10100	Fast sampling enable, ON is fast sampling, OFF is slow sampling	
		Y10101	Write in user-defined parameter	
		Y10102	Reset	
		Y10103	Calibration/resonance measurement	
	CH2	Y10104	Fast sampling enable, ON is fast sampling, OFF is slow sampling	
		Y10105	Write in user-defined parameter	
		Y10106	Reset	
		Y10107	Calibration/resonance measurement	

	CH3	Y10110	Fast sampling enable, ON is fast sampling, OFF is slow sampling	
		Y10111	Write in user-defined parameter	
		Y10112	Reset	
		Y10113	Calibration/resonance measurement	
	CH4	Y10114	Fast sampling enable, ON is fast sampling, OFF is slow sampling	
		Y10115	Write in user-defined parameter	
		Y10116	Reset	
		Y10117	Calibration/resonance measurement	
Input coil	CH1	X10100	CH1 resonance frequency measurement complete sign	
	CH2	X10101	CH2 resonance frequency measurement complete sign	
	CH3	X10102	CH3 resonance frequency measurement complete sign	
	CH4	X10103	CH4 resonance frequency measurement complete sign	
Input register	CH1	ID10100	Present digital value	Dword
		ID10102	Present weight	Dword
	CH2	ID10104	Present digital value	Dword
		ID10106	Present weight	Dword
	CH3	ID10108	Present digital value	Dword
		ID10110	Present weight	Dword
	CH4	ID10112	Present digital value	Dword
		ID10114	Present weight	Dword

.....

The I/O address of module 16:

Soft component		Address	Explanation	Mark
Output coil	CH1	Y11700	Fast sampling enable, ON is fast sampling, OFF is slow sampling	
		Y11701	Write in user-defined parameter	
		Y11702	Reset	
		Y11703	Calibration/resonance measurement	
	CH2	Y11704	Fast sampling enable, ON is fast sampling, OFF is slow sampling	
		Y11705	Write in user-defined parameter	
		Y11706	Reset	
		Y11707	Calibration/resonance measurement	
	CH3	Y11710	Fast sampling enable, ON is fast sampling, OFF is slow sampling	
		Y11711	Write in user-defined parameter	
		Y11712	Reset	
		Y11713	Calibration/resonance measurement	

	CH4	Y11714	Fast sampling enable, ON is fast sampling, OFF is slow sampling	
		Y11715	Write in user-defined parameter	
		Y11716	Reset	
		Y11717	Calibration/resonance measurement	
Input coil	CH1	X11700	CH1 resonance frequency measurement complete sign	
	CH2	X11701	CH2 resonance frequency measurement complete sign	
	CH3	X11702	CH3 resonance frequency measurement complete sign	
	CH4	X11703	CH4 resonance frequency measurement complete sign	
Input register	CH1	ID11500	Present digital value	Dword
		ID11502	Present weight	Dword
	CH2	ID11504	Present digital value	Dword
		ID11506	Present weight	Dword
	CH3	ID11508	Present digital value	Dword
		ID11510	Present weight	Dword
	CH4	ID11512	Present digital value	Dword
		ID11514	Present weight	Dword

Note: XD-E1WT-A has no CH2~CH4; XD-E2WT-A has no CH3~CH4.

10-7. Working mode

There are two methods to set the working mode:

1. set through the control panel
2. set through Flash register

Open the XD PLC software, click the menu configure/expansion module setting.

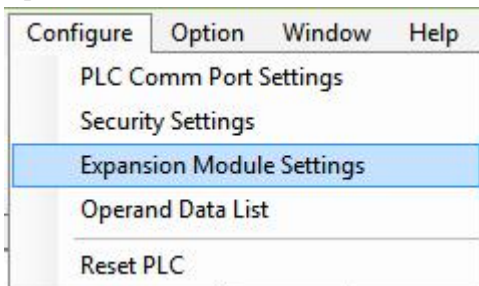

Choose the correct model and configuration information:

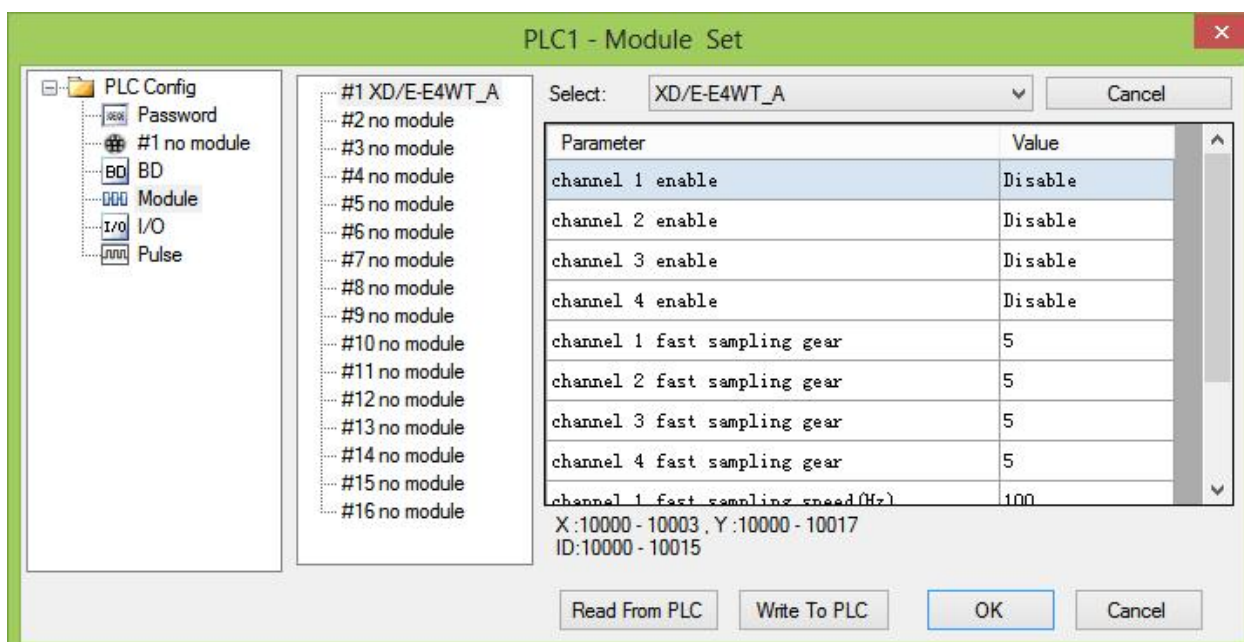

Flash register setting:

The expansion module can set the gear and user-defined fast sampling frequency through PLC flash register SFD.

Module no.	SFD address	Module no.	SFD address
#1	SFD350~SFD359	#9	SFD430~SFD439
#2	SFD360~SFD369	#10	SFD440~SFD449
#3	SFD370~SFD379	#11	SFD450~SFD459
#4	SFD380~SFD389	#12	SFD460~SFD469
#5	SFD390~SFD399	#13	SFD470~SFD479
#6	SFD400~SFD409	#14	SFD480~SFD489
#7	SFD410~SFD419	#15	SFD490~SFD499
#8	SFD420~SFD429	#16	SFD500~SFD509

SFD350~SFD359 register explanation:

SFD		Bit7	Bit6	Bit5	Bit4	Bit3	Bit2	Bit1	Bit0	Explanation	
SFD350	Byte0	CH4 enable	CH3 enable	CH2 enable	CH1 enable	-	-	-	-	Slow sampling default speed is 5Hz, fast sampling has 15 user-defined speed gears	
	Byte1	CH2 fast sampling speed gear (0-15)				CH1 fast sampling speed gear (0-15)					
SFD351	Byte2	CH4 fast sampling speed gear (0-15)				CH3 fast sampling speed gear (0-15)					
	Byte3	CH1 user-defined fast sampling speed (Hz) (10-255)									
SFD352	Byte4	CH2 user-defined fast sampling speed (Hz) (10-255)									
	Byte5	CH3 user-defined fast sampling speed (Hz) (10-255)									
SFD353	Byte6	CH4 user-defined fast sampling speed (Hz) (10-255)									
	Byte7	-									
SFD354~359		-									

Note: XD-E1WT-A has no CH2~CH4; XD-E2WT-A has no CH3~CH4.

10-8. Module setting

Take module no.1 as an example:

Weight unit setting:

Write in weight through instruction TO. For example, the object weight is 1kg, write in 1 means the unit is kg, write in 1000 means the unit is g, write in 10000 means the unit is 0.1g.

Sampling frequency:

Sampling frequency includes fast sampling and slow sampling. The two states can be switched through Y10003. The default frequency of slow sampling is 5Hz. The fast sampling has 15 gears which can be selected in PLC expansion module configuration table. Each gear from 0 to 14 has different sampling frequency and filter parameters. User can choose suitable gear as actual needs, please refer to default gear parameter table. Gear 15 is user-defined mode, it can set the sampling frequency and filter parameter by user. User can set the fast sampling frequency (this parameter is invalid for other gears) by software and set the filter parameter by instruction FROM and TO.

Resonance frequency measurement:

1. resonance frequency is the fixed vibration interference generated by machine, it will be tested when installing the machine at the beginning.
2. repower on the module or write in 0 for the weight by instruction FROM and TO.
3. switch to fast sampling mode (Y10000 is ON), set on Y10003. The module will enter resonance frequency measurement. Then set OFF Y10003. X10000 will be ON when the measurement completed. The result will be automatic saved in the module. (it is necessary to test the resonance frequency in fast sampling mode)

Calibration:

Please calibrate the pressure sensor for the first time using.

Take module channel 1 as an example:

1. make sure the module connected to the weighting system. Please check if the value in ID10000 fluctuated (the fluctuation range is related to sensor range), the pressure value is increasing as the load increasing. If ID10000 has no value, please check the sensor wiring. If the pressure value is decreasing as the load increasing, the sensor positive and negative point may connect backward.
2. close fast sampling enable bit Y10000 before calibration.
3. make the pressure sensor without load, set to zero after the scale is stable, set ON Y10002(set to zero enable bit).
4. put the load on the scale, write in the load weight by instruction TO, calibrate the system after the scale is stable, set ON Y10003(calibration enable bit). The calibration completed when ID10002 is same to the load weight, set OFF Y10003.
5. Hereto, the calibration finished. The module will automatic adjust the result according to the idle load value and calibration value when weighing, and finally get the correct weight.

Default gear parameter:

Speed gear	Fast sampling speed (Hz)	Fast sampling filter width	Kalman filter depth	IIR bandwidth coefficient	IIR attenuation ratio coefficient	Lowpass cut-off frequency
0	60	5	30	10	10	10
1	80	5	40	10	10	10
2	100	10	50	10	10	10
3	120	10	60	10	10	10
4	140	15	70	10	10	15
5	160	15	80	10	10	15
6	180	20	90	10	10	15
7	200	20	100	10	10	15
8	220	25	110	10	10	15
9	240	25	120	10	10	15
10	250	25	125	10	10	15
11	250	25	125	10	10	15
12	250	25	125	10	10	15
13	250	25	125	10	10	15
14	255	25	125	10	10	15

10-9. Instruction FROM and TO

The reading and writing of XD-EnWT-A module needs to be completed through the FROM/TO instruction in the sequential function block, as shown in the figure below:

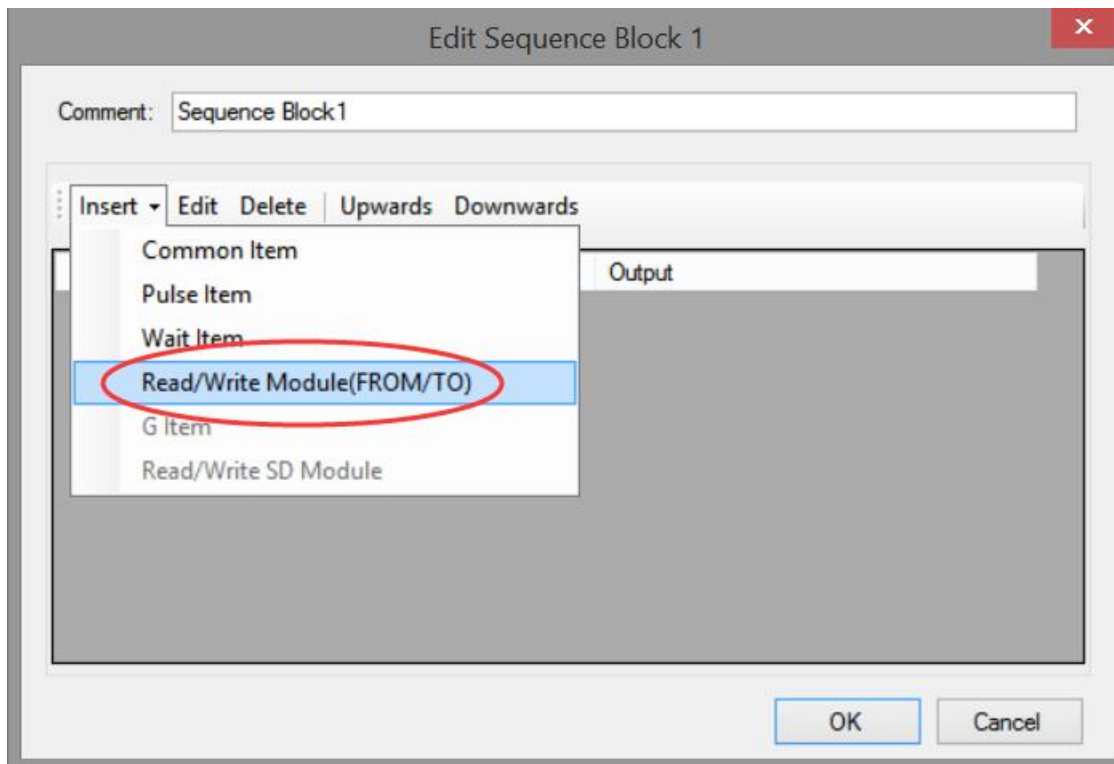

(a) Insert FROM/TO module

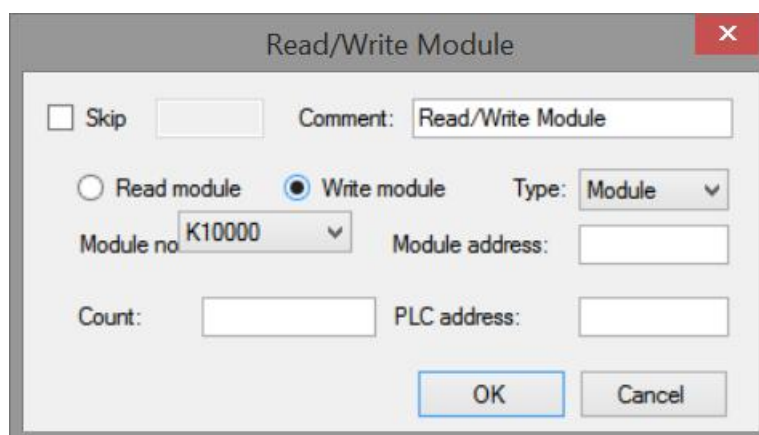

(b) Write instruction

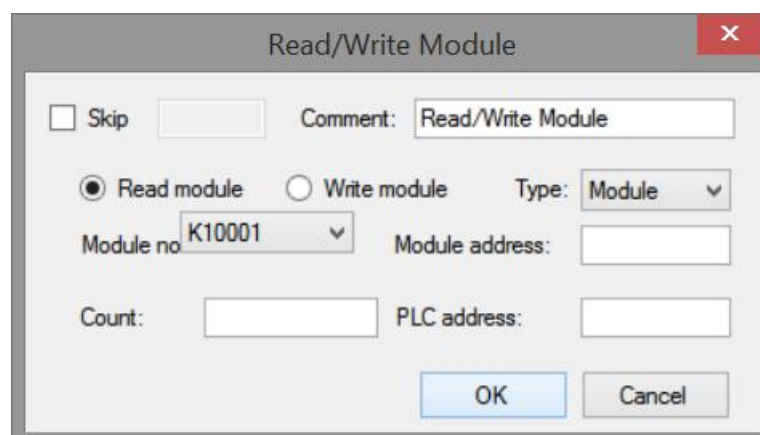

(c) Read instruction

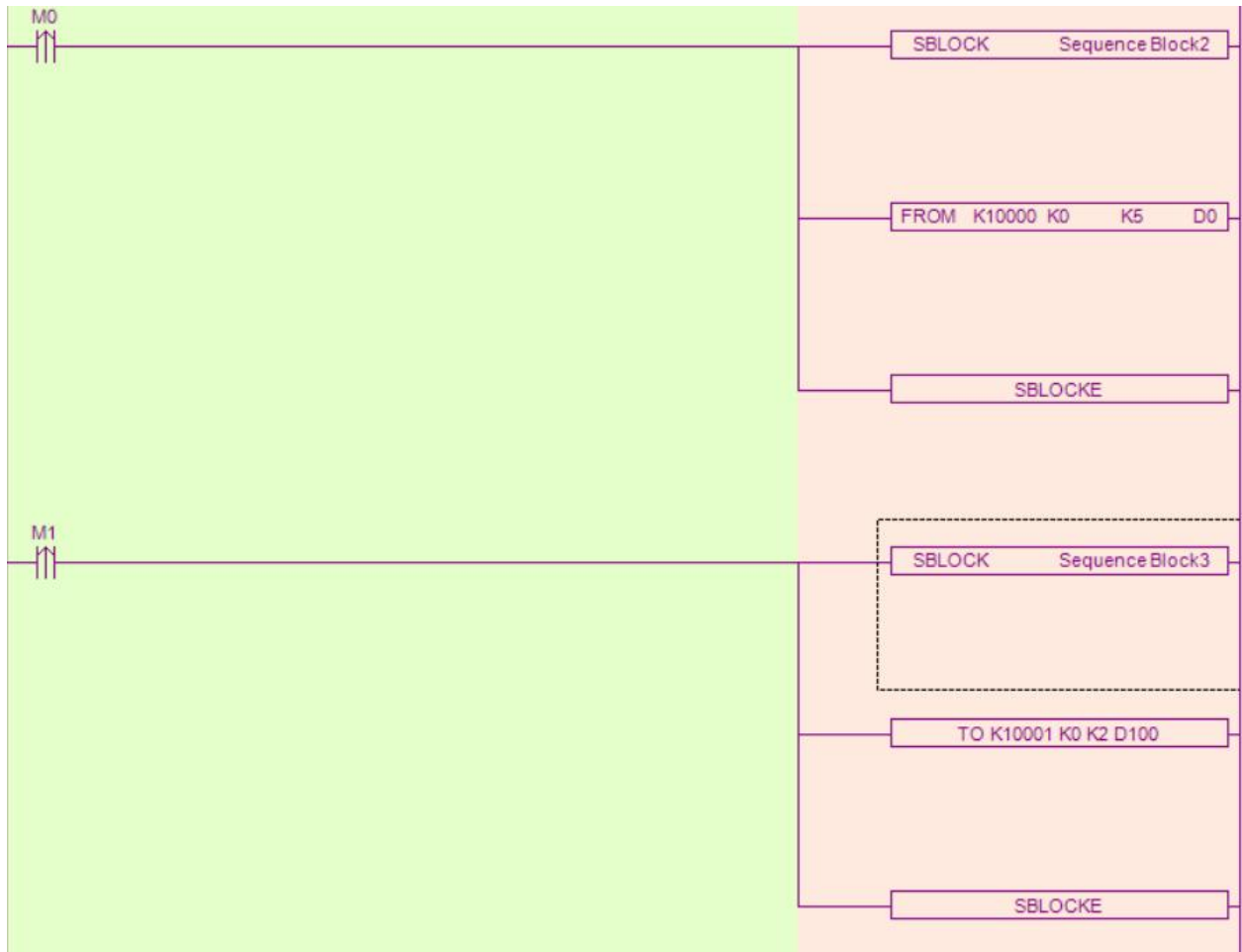

(d) Ladder chart

Instructions:

- Write instruction TO

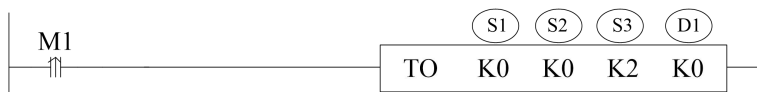

Function: write the PLC register data to module specified address, the unit is word.

Operand:

S1: target module number. Operand: K, TD, CD, D, FD.

S2: module first address. Operand: K, TD, CD, D, FD.

S3: write in register quantity. Operand: K, TD, CD, D, FD.

D1: write in data first address in PLC.

- Read instruction FROM

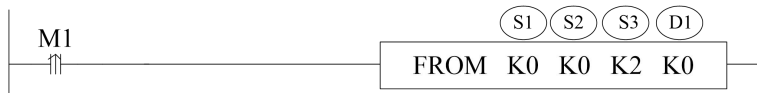

Function: read the module data to PLC register, the unit is word.

Operand:

S1: target module number. Operand: K, TD, CD, D, FD.

S2: module first address. Operand: K, TD, CD, D, FD.

S3: read register quantity. operand: K, TD, CD, D, FD.

D1: PLC register first address.

Note:

1. From/TO instruction can only be written in sequence function block, XD series PLC with firmware version less than v3.4.5 only allows up to 8 function blocks; XD/XL series PLC with firmware version v3.4.5 and above can write up to 100 blocks in the program, but can only run up to 8 blocks at the same time.
2. The starting number of module starts from k10000, k10000 is module 1 and k10001 is module 2. By analogy, module 16 is K10015.

Module parameter internal address:

From/ToData		
K0	CH1 calibration weight	Dword
K2	CH1 fast sampling filter width	Word
K3	CH1 filter depth	Word
K4	CH1 bandwidth coefficient	Word
K5	CH1 attenuation coefficient	Word
K6	CH1 low pass cutoff frequency	Word
K7	CH1 resonance frequency (0.1HZ)	Word
K8	CH2 calibration weight	Dword
K10	CH2 fast sampling filter width	Word
K11	CH2 filter depth	Word
K12	CH2 bandwidth coefficient	Word
K13	CH2 attenuation coefficient	Word
K14	CH2 low pass cutoff frequency	Word
K15	CH2 resonance frequency (0.1HZ)	Word
K16	CH3 calibration weight	Dword
K18	CH3 fast sampling filter width	Word
K19	CH3 filter depth	Word
K20	CH3 bandwidth coefficient	Word
K21	CH3 attenuation coefficient	Word
K22	CH3 low pass cutoff frequency	Word
K23	CH3 resonance frequency (0.1HZ)	Word

K24	CH4 calibration weight	Dword
K26	CH4 fast sampling filter width	Word
K27	CH4 filter depth	Word
K28	CH4 bandwidth coefficient	Word
K29	CH4 attenuation coefficient	Word
K30	CH4 low pass cutoff frequency	Word
K31	CH4 resonance frequency (0.1HZ)	Word

Parameter explanation:

1. calibration weight: write in weight when calibrating
2. fast sampling filter width: the average times of fast sampling filter
3. attenuation coefficient: the larger the more stable, but too large will make the sampling value distortion and sensitivity reduction.
4. bandwidth coefficient: the larger the more stable, but too large will make the sampling value distortion and sensitivity reduction.
5. resonance frequency: the scale has natural frequency; this frequency can be known by internal measurement. The more accurate of the frequency, the better the filtering effect.
6. Filter depth: the larger the data, more stable the system, the lower the sensitivity.

10-10. A/D transformation diagram

The relationship between input voltage value and A/D transformed digital value:

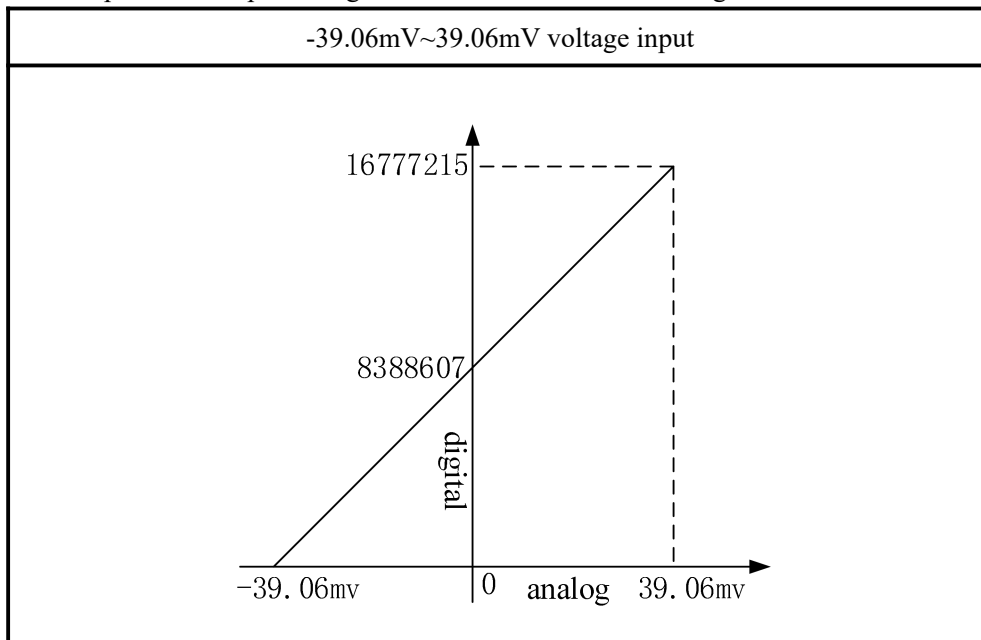

10-11. Application program

Take module 1 as an example:

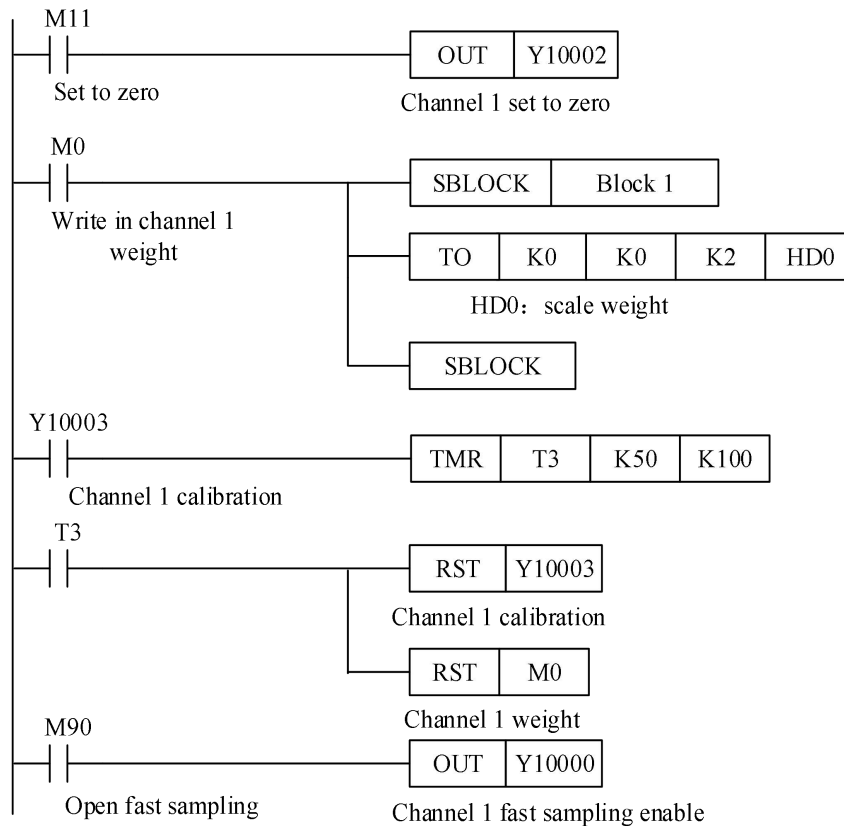

Explanation:

Set to zero through Y10002.

Write in the weight value through instruction TO. First send the weight value in HD0, set ON M0, write the value of HD0 to module 1 channel 1.

Put the load, calibrate the scale through Y10003. The calibration is finished when the weight value is equal to the weight display value.

Switch the slow or fast sampling through Y10000.

Y10000 open, channel 1 will collect data with fast sampling frequency.

Y10000 close, channel 1 will collect data with slow sampling frequency.

11. 2 channels pressure module XD-E2WT-B

11-1. Features

XD-E2WT-B is the expansion module of XD series PLC. It can test the voltage in the range of 0mV~10mV or the voltage signal from pressure sensor. Then it can transform the voltage to digital value through A/D transformation and do calculation.

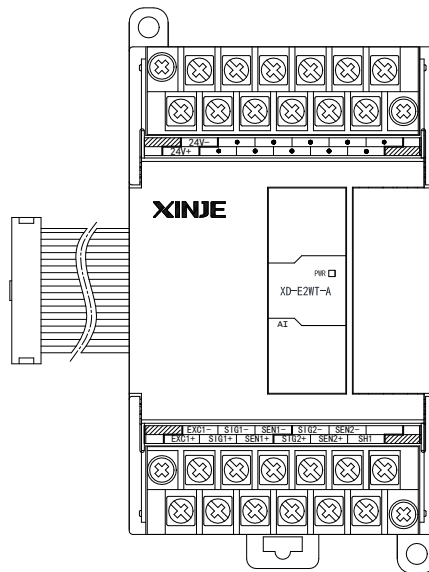

Features:

- 2 channels pressure sensor voltage signal input
- Test voltage signal in the range of 0~10mV
- 24-bit A/D transformation
- XD3/XD3E series PLC can connect 10 XD-E2WT-B modules
- XD5/XDM/XDC/XD5E/XDME/XDH series PLC can connect 16 XD-E2WT-B modules
- XD1, XD2 cannot extend modules

Specifications:

Input range	DC 0~10mV
Resolution	1/16777216 (24Bit)
Integrated precision	>0.01%
Transformation speed	10-200 times/second
Power supply	DC24V±10%, 100mA
Sensor power supply	5VDC/120mA, can parallel 4 pieces of 350Ω pressure sensor
Installation	Mount on DIN46277 rail (width 35mm) or fix with screw M3
Dimension	63mm×108mm×89.9mm
Working environment	No corrosive gas
Ambient temperature	-10°C~50°C
Humidity	5~95%
Software version	V3.4 and higher version

11-2. Terminals

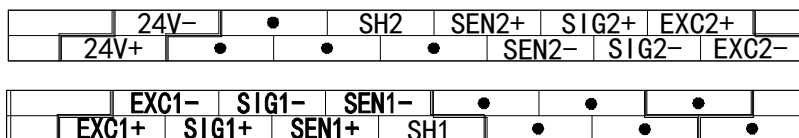

Channel	Terminal	Signal	Meaning
CH1	EXC1+	Excitation+	Connect to sensor power supply input
	EXC1-	Excitation-	
	SIG1+	Signal +	Connect to sensor signal output
	SIG1-	Signal -	
	SEN1+	Feedback +	Connect to sensor feedback voltage output
	SEN1-	Feedback -	
	SH1	Shield	Connect to sensor ground
CH2	EXC2+	Excitation+	Connect to sensor power supply input
	EXC2-	Excitation-	
	SIG2+	Signal +	Connect to sensor signal output
	SIG2-	Signal -	
	SEN2+	Feedback +	Connect to sensor feedback voltage output

	SEN2-	Feedback -	
	SH2	Shield	Connect to sensor ground
	24V+	+24V power supply	Module power supply
	24V-	Common terminal	

11-3. External connection

For external connection, please note the following cases:

- Please use the 24V power supply on the PLC to avoid interference.
- Please use shield cable and single-point connect to the ground.

Power supply wiring

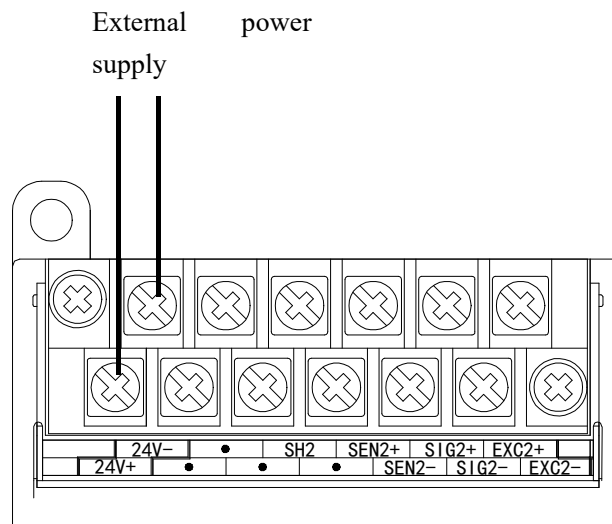

Connect to sensor

6 wires sensor:

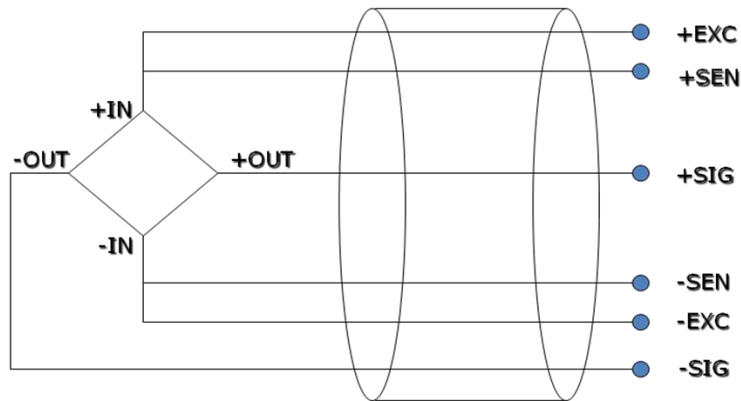

4 wires sensor:

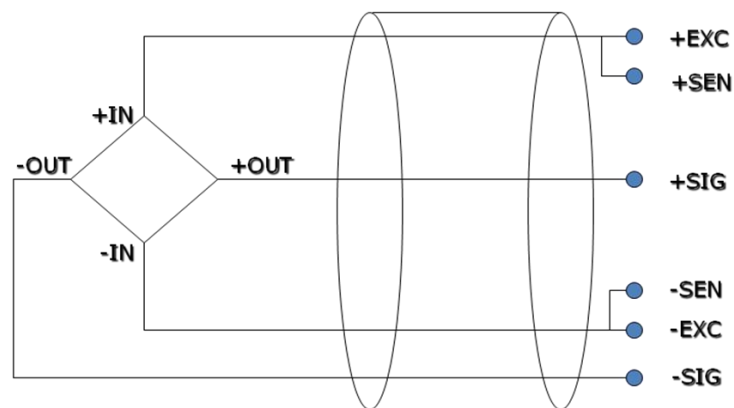

Notes: if the sensor is 4 wires mode, please connect EXC1- and SEN1-, EXC1+ and SEN1+.

11-4. Weighing system

A typical weighing system:

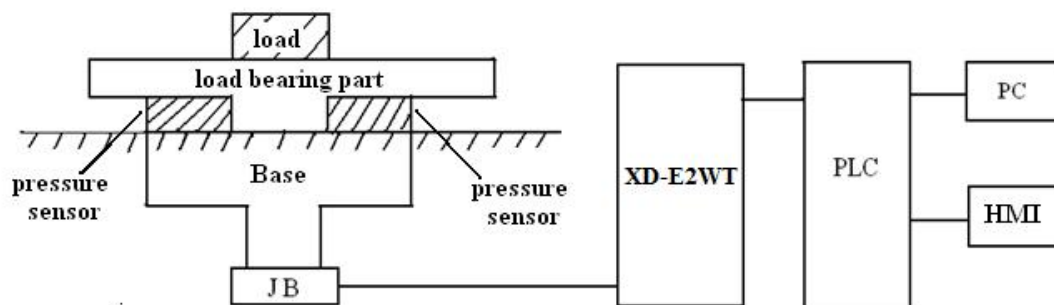

Loading bearing part: to support the load. Such as flat, hopper, container, air transport car...

Pressure sensor: transform the weight to voltage signal.

Assembly part: make sure the pressure sensor can work correctly, assembly part and direct part can avoid overload. Overload will cause measurement error and sensor damage.

Connection box (JB): to collect several sensor signals.

XD-E2WT-B: can be used as an electronic assessment device, it gets the pressure sensor signal and makes

further assessment.

11-5. Module functions

XD-E2WT-B has the follow functions:

- Adjust the pressure sensor
- Collect the pressure sensor signal
- Calculate the weight value
- 0~10mV voltage signal test

11-5-1. Pressure sensor

The pressure sensor is based on resistance strain effect, see the following diagram:

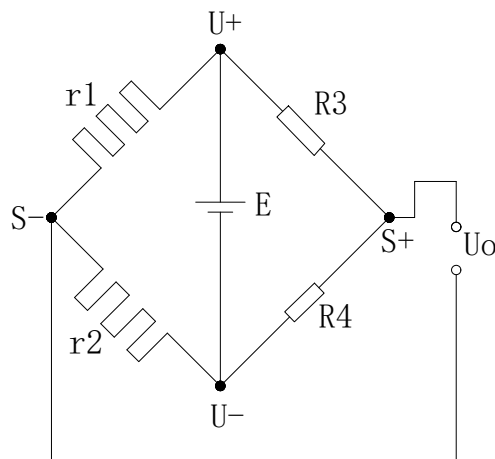

R1 and R2 is strain resistor which make bridge circuit with R3 and R4. With the change of R1 and R2, the bridge circuit will lose the balance, unbalance voltage U_o will be produced as the output of sensor.

$U+$ and $U-$ are positive and negative point of the sensor power supply. Please select the 5V power of the module or from outside.

$S+$ and $S-$ are positive and negative point of the sensor output. Connect the output to the module to test the weight.

11-6. I/O address

Expansion module no.1 register address

Soft component		Address	Explanation	Note
Output coil	CH1	Y10000	resonance measurement	
		Y10001	write in user-defined parameters	
		Y10002	Reset	
		Y10003	Calibration	
	CH2	Y10004	resonance measurement	

		Y10005	write in user-defined parameters	
		Y10006	Reset	
		Y10007	Calibration	
Input coil	CH1	X10000	CH1 error	
	CH1	X10001	CH1 trapped wave enable	
	CH2	X10002	CH2 error	
	CH2	X10003	CH2 trapped wave enable	
Input register	CH1	ID10000	Present digital value /CH1 resonance frequency	Dword
		ID10002	Present weight	Dword
	CH2	ID10004	Present digital value / CH2 resonance frequency	Dword
		ID10006	Present weight	Dword

Expansion module no.2 register address

Soft component		Address	Explanation	Note
Output coil	CH1	Y10100	resonance measurement	
		Y10101	write in user-defined parameters	
		Y10102	Reset	
		Y10103	Calibration	
	CH2	Y10104	resonance measurement	
		Y10105	write in user-defined parameters	
		Y10106	Reset	
		Y10107	Calibration	
Input coil	CH1	X10100	CH1 error	
	CH1	X10101	CH1 trapped wave enable	
	CH2	X10102	CH2 error	
	CH2	X10103	CH2 trapped wave enable	
Input register	CH1	ID10100	Present digital value /CH1 resonance frequency	Dword
		ID10102	Present weight	Dword
	CH2	ID10104	Present digital value / CH2 resonance frequency	Dword
		ID10106	Present weight	Dword

.....

Expansion module no.16 register address

Soft component		Address	Explanation	Note
Output coil	CH1	Y11700	resonance measurement	
		Y11701	write in user-defined parameters	
		Y11702	Reset	
		Y11703	Calibration	
	CH2	Y11704	resonance measurement	

		Y11705	write in user-defined parameters	
		Y11706	Reset	
		Y11707	Calibration	
Input coil	CH1	X11700	CH1 error	
	CH1	X11701	CH1 trapped wave enable	
	CH2	X11702	CH2 error	
	CH2	X11703	CH2 trapped wave enable	
Input register	CH1	ID11500	Present digital value /CH1 resonance frequency	Dword
		ID11502	Present weight	Dword
	CH2	ID11504	Present digital value / CH2 resonance frequency	Dword
		ID11506	Present weight	Dword

11-7. Working mode

There are two modes to set the working mode:

1. set through the control panel
2. set through the Flash register

Open the PLC software, click configure/expansion module settings:

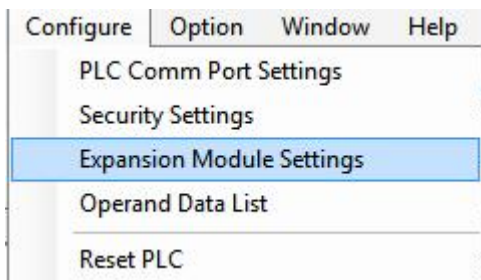

Choose suitable model information:

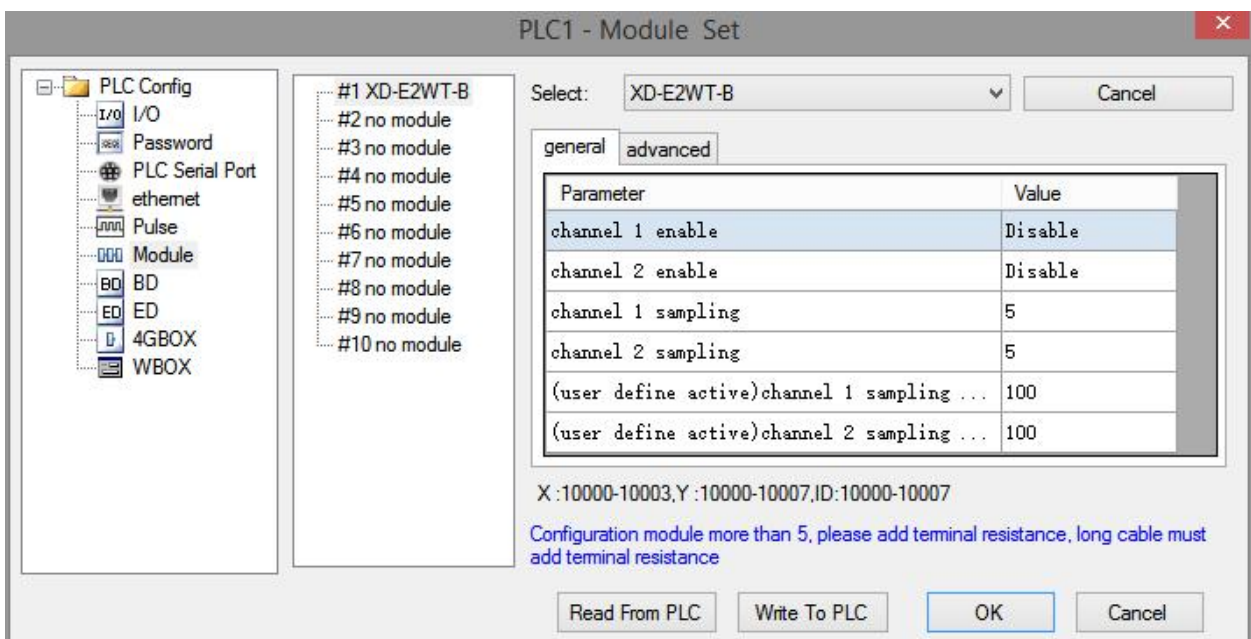

Flash register setting:

The expansion module can set gear and user-defined fast sampling frequency through the PLC internal flash register SFD.

Module no.	SFD address	Module no.	SFD address
#1	SFD350~SFD359	#9	SFD430~SFD439
#2	SFD360~SFD369	#10	SFD440~SFD449
#3	SFD370~SFD379	#11	SFD450~SFD459
#4	SFD380~SFD389	#12	SFD460~SFD469
#5	SFD390~SFD399	#13	SFD470~SFD479
#6	SFD400~SFD409	#14	SFD480~SFD489
#7	SFD410~SFD419	#15	SFD490~SFD499
#8	SFD420~SFD429	#16	SFD500~SFD509

SFD350~SFD359 register explanation:

SFD		Bit7	Bit6	Bit5	Bit4	Bit3	Bit2	Bit1	Bit0	
SFD350	Byte0			CH2 enable	CH1 enable					
	Byte1	CH2 fast sampling gear (0-12)			CH1 fast sampling gear (0-12)					
SFD351	Byte2									
	Byte3	CH1 user-defined fast sampling speed (Hz) (10-200)								
SFD352	Byte4	CH2 user-defined fast sampling speed (Hz) (10-200)								
	Byte5	-								

11-8. Module setting

Take module no.1 channel 1 as an example:

Module parameter setting:

When the PLC sampling gear is set to 12, PLC will write in the parameters through the TO instruction. Other

gears are fixed parameters, cannot be changed.

The parameter list:

FromToData	Explanation	
K0	CH1 calibration weight	Dword
K2	CH1 mean filtering width (0-50)	Word
K3	CH1 median filtering width	Word
K4	CH1 Kalman filtering depth (0-200)	Word
K5	CH1 first order filter gear (0-6)	Word
K6	CH1 filter attenuation multiple (0-40)	Word
K7	CH1 user error code	Word
K8	CH2 calibration weight	Dword
K10	CH2 mean filtering width (0-50)	Word
K11	CH2 median filtering width	Word
K12	CH2 Kalman filtering depth (0-200)	Word
K13	CH2 first order filter gear (0-6)	Word
K14	CH2 filter attenuation multiples	Word
K15	CH2 user error code	Word

Default gear list:

Speed gear	Mean filtering width	Median filtering width	Kalman filtering depth	First order lag gear	Trapped wave attenuation multiples
0	3	0	0	1	0
1	3	3	0	1	0
2	5	5	40	2	2
3	8	7	0	2	20
4	10	9	0	2	30
5	12	10	0	3	40
6	15	12	20	3	40
7	20	15	20	3	40
8	12	10	20	2	30
9	15	10	20	3	30
10	15	12	20	4	30
11	15	15	40	4	40

Weight unit setting:

Write in weight through instruction TO. For example, the object weight is 1kg, write in 1 means the unit is kg, write in 1000 means the unit is g, write in 10000 means the unit is 0.1g.

Resonance frequency measurement:

1. resonance frequency is the fixed vibration interference generated by machine, it will be tested when

installing the machine at the beginning.

2. repower on the module, confirm the parameters are set.

3. set ON Y10000, module will automatically measure the resonance frequency, monitor the ID10000, if it shows the measuring frequency, set OFF Y10000.

Calibration:

Please calibrate the pressure sensor for the first time using.

Take module channel 1 as an example:

1. make sure the module connected to the weighting system. Please check if the value in ID10000 fluctuated (the fluctuation range is related to sensor range), the pressure value is increasing as the load increasing. If ID10000 has no value, please check the sensor wiring. If the pressure value is decreasing as the load increasing, the sensor positive and negative point may connect backward.

2. make the pressure sensor without load, set to zero after the scale is stable, set ON Y10002(set to zero enable bit).

3. put the load on the scale, write in the load weight by instruction TO, calibrate the system after the scale is stable, set ON Y10003(calibration enable bit). The calibration completed when ID10002 is same to the load weight, set OFF Y10003.

4. Hereto, the calibration finished. The module will automatic adjust the result according to the idle load value and calibration value when weighing, and finally get the correct weight.

11-9. Instruction FROM and TO

The reading and writing of XD-E2WT-B module needs to be completed through the FROM/TO instruction in the sequential function block, as shown in the figure below:

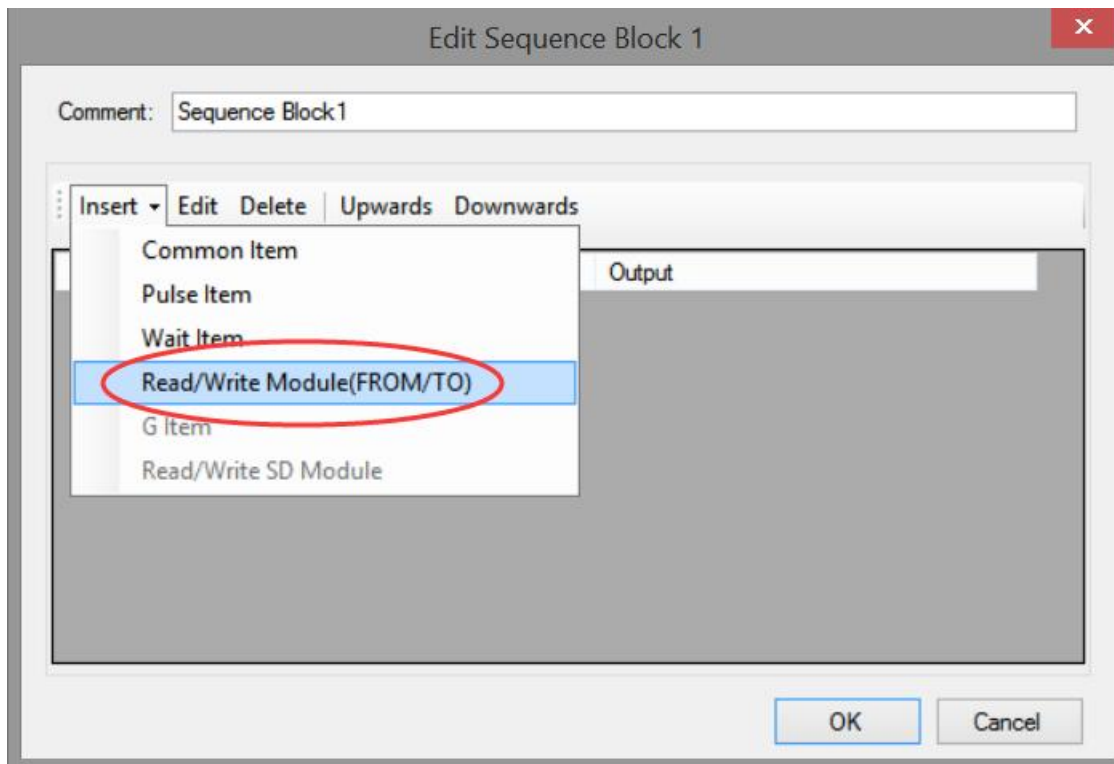

(a) Insert FROM/TO module

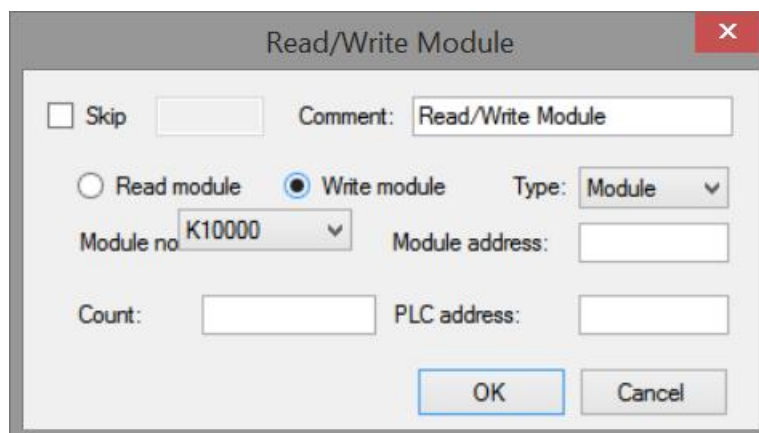

(b) Write instruction

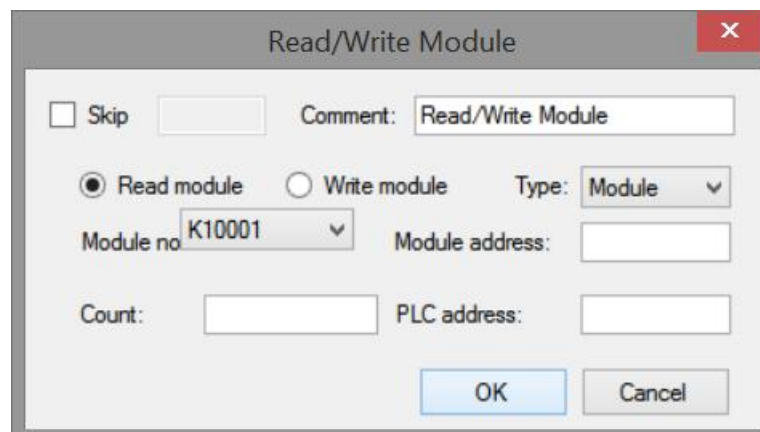

(c) Read instruction

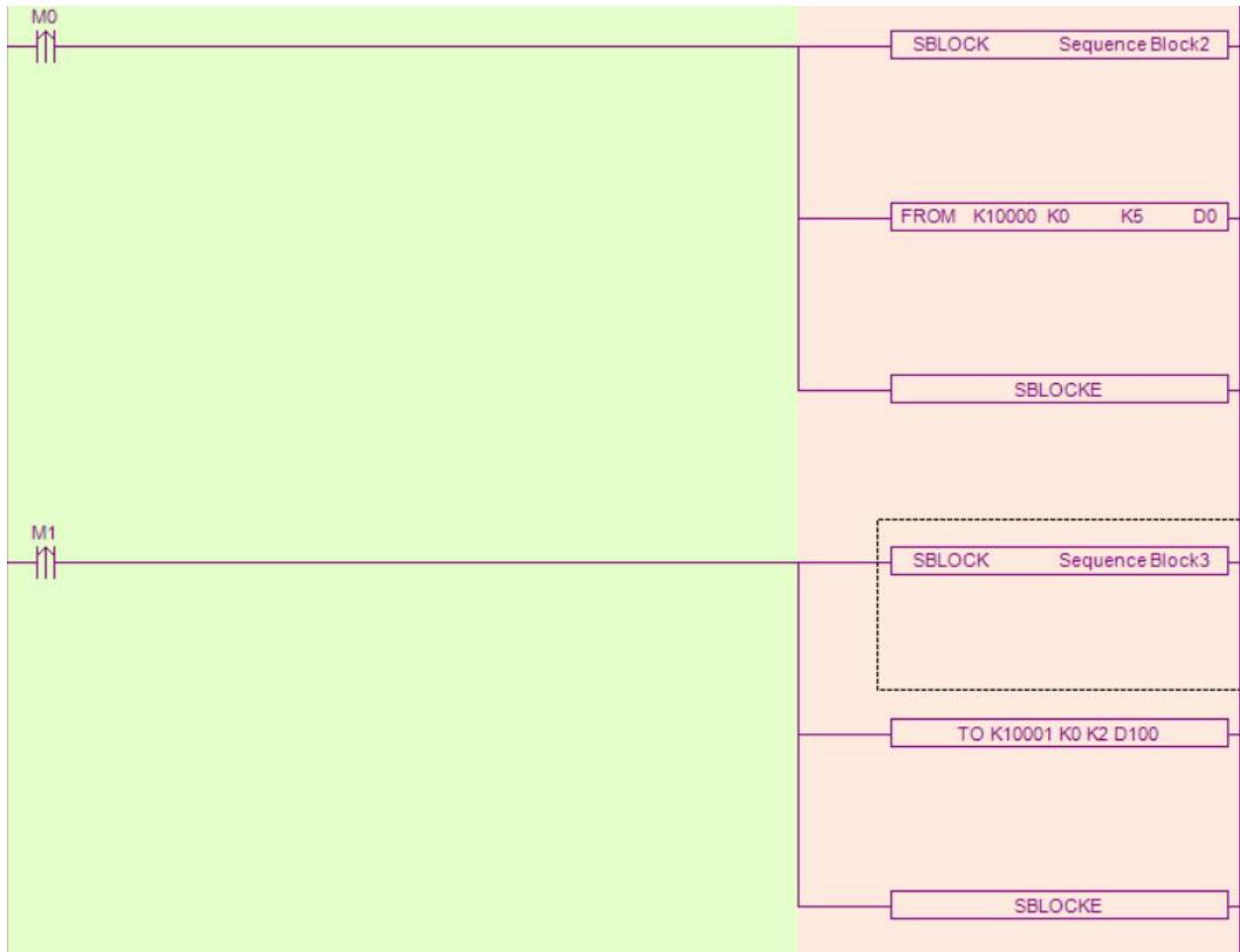

(d) Ladder chart

Write instruction TO

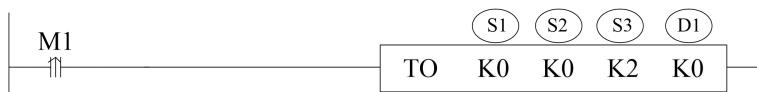

Function: write the PLC register data to module specified address, the unit is word.

Operand:

S1: target module number. Operand: K, TD, CD, D, FD.

S2: module first address. Operand: K, TD, CD, D, FD.

S3: write in register quantity. Operand: K, TD, CD, D, FD.

D1: write in data first address in PLC.

Read instruction FROM



Function: read the module data to PLC register, the unit is word.

Operand:

S1: target module number. Operand: K, TD, CD, D, FD.

S2: module first address. Operand: K, TD, CD, D, FD.

S3: read register quantity. operand: K, TD, CD, D, FD.

D1: PLC register first address.

Note:

- 1. From/TO instruction can only be written in sequence function block, XD series PLC with firmware version less than v3.4.5 only allows up to 8 function blocks; XD/XL series PLC with firmware version v3.4.5 and above can write up to 100 blocks in the program, but can only run up to 8 blocks at the same time.
- 2. The starting number of module starts from k10000, k10000 is module 1 and k10001 is module 2. By analogy, module 16 is K10015.

11-10. A/D transformation diagram

The relationship between input voltage value and A/D transformed digital value:

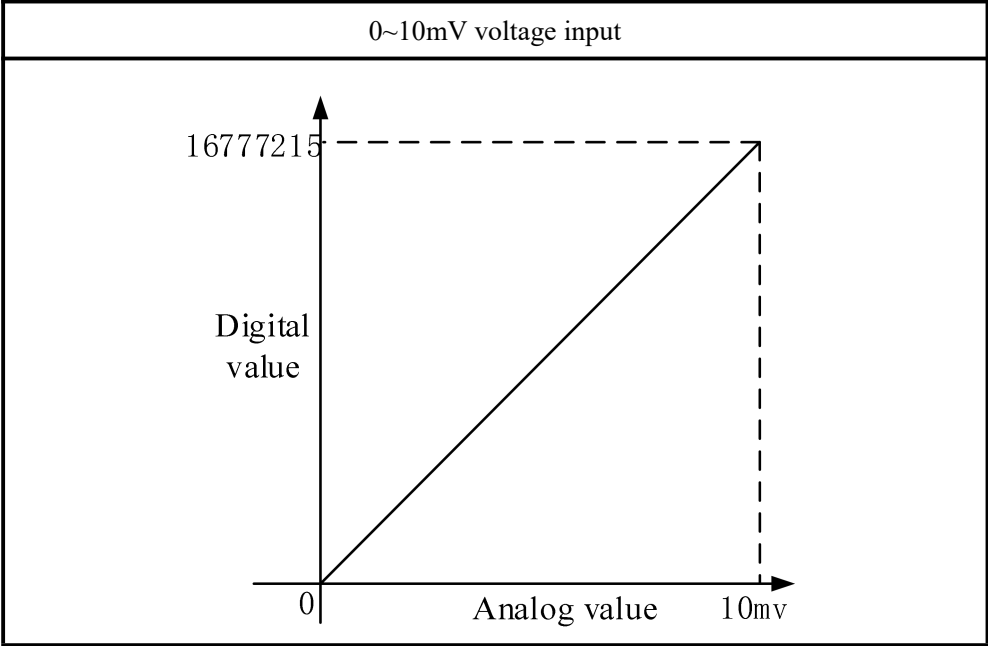

11-11. Application program

Take module 1 channel 1 as an example:

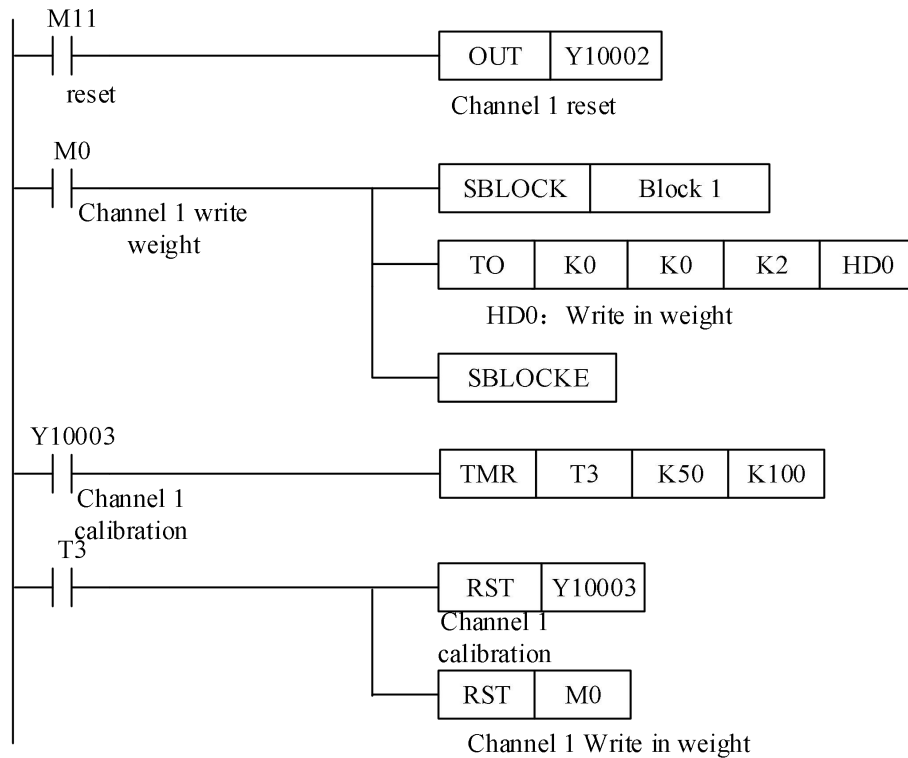

Explanation:

Set to zero through Y10002.

Write in the weight value through instruction TO. First store the weight value in HD0, set ON M0, write the value of HD0 to module 1 channel 1.

Calibrate the scale through Y10003. The calibration is finished when the weight value is equal to the weight display value.

12. N channels pressure module XD-EnWT-C

12-1. Features

This chapter mainly introduces XD-E1WT-C, XD-E2WT-C, XD-E4WT-C module specifications, terminal description, system composition, module functions and parameters, external connections, analog-to-digital conversion diagram and related programming examples.

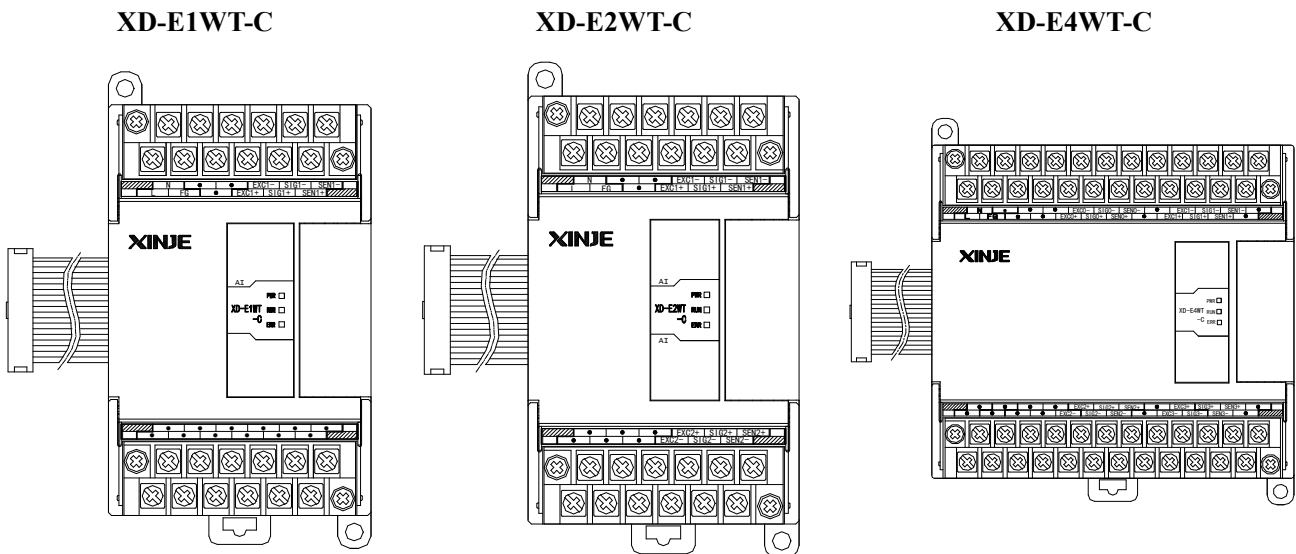

Features:

The 1, 2, 4 channels of pressure measurement module XD-EnWT-C, as an extension module of XD series PLC, can be used to detect the voltage signal of 0~10mV or collect the voltage signal of pressure sensor, and convert the analog voltage value into digital value through A/D and carry out operation.

- The analog voltage signal of 1 / 2 / 4 channel pressure sensor can be collected.
- It can detect the voltage signal of 0-10mV.
- 20-bit high precision A / D conversion.
- As a special function module of XD series, XD3/XD3E can connect up to 10 modules on the right side of PLC main unit, XD5/XDM/XDC/XD5E/XDME/XDH can expand 16 modules, XD1/XD2 does not support expansion modules.

Specifications:

Input range	DC 0~10mV (sensor 2mv/v)
AD real resolution	1/1048575 (20bit)
Max display resolution	1/300000
Non-linear	0.01%F.S
Transformation speed	150/300/450 times/second (optional)
Power supply	AC220V±10% 50/60Hz
Sensor power supply	5VDC/120mA, can parallel 4 pieces of 350Ω pressure sensor
Dimension	63mm×108mm×89.9mm (XD-E1/2WT-C) 108.6×108mm×89.9mm (XD-E4WT-C)
Installation	Mount on DIN46277 rail (width 35mm) or fix with screw M3
Software version	V3.5.1 and higher version
Working environment	No corrosive gas
Ambient temperature	-10°C~50°C
Humidity	5~95%RH (no condensation)

12-2. Terminals

XD-E1WT-C:

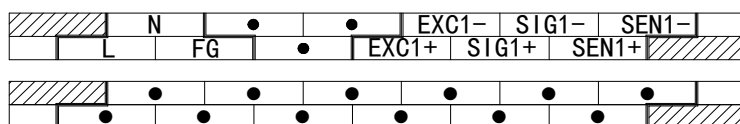

XD-E2WT-C:

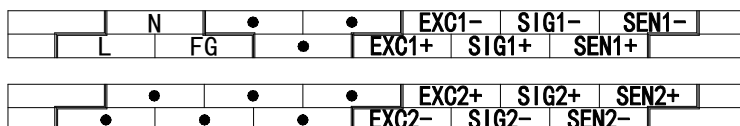

XD-E4WT-C:

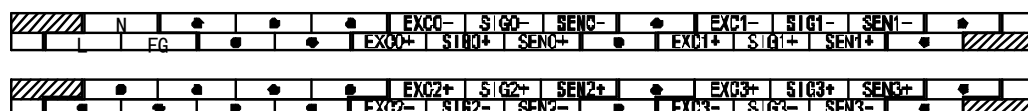

XD-E1WT-C:

Channel	Terminal	Signal	Meaning
CH1	EXC1+	Excitation +	Connect to sensor power supply input
	EXC1-	Excitation -	
	SIG1+	Signal +	Connect to sensor signal output
	SIG1-	Signal -	
	SEN1+	Feedback +	Connect to sensor feedback voltage output
	SEN1-	Feedback -	
-	L, N	Module power supply	Give power to module, AC220V \pm 10% 50/60Hz
	FG	Power supply ground	Connect to ground

XD-E2WT-C:

Channel	Terminal	Signal	Meaning
CH1	EXC1+	Excitation +	Connect to sensor power supply input
	EXC1-	Excitation -	
	SIG1+	Signal +	Connect to sensor signal output
	SIG1-	Signal -	
	SEN1+	Feedback +	Connect to sensor feedback voltage output
	SEN1-	Feedback -	
CH2	EXC2+	Excitation +	Connect to sensor power supply input
	EXC2-	Excitation -	
	SIG2+	Signal +	Connect to sensor signal output
	SIG2-	Signal -	
	SEN2+	Feedback +	Connect to sensor feedback voltage output
	SEN2-	Feedback -	
-	L, N	Module power supply	Give power to module, AC220V \pm 10% 50/60Hz
	FG	Power supply ground	Connect to ground

XD-E4WT-C:

Channel	Terminal	Signal	Meaning
CH1	EXC0+	Excitation +	Connect to sensor power supply input
	EXC0-	Excitation -	
	SIG0+	Signal +	Connect to sensor signal output
	SIG0-	Signal -	
	SEN0+	Feedback +	Connect to sensor feedback voltage output
	SEN0-	Feedback -	
CH2	EXC1+	Excitation +	Connect to sensor power supply input
	EXC1-	Excitation -	

	SIG1+	Signal +	Connect to sensor signal output
	SIG1-	Signal -	
	SEN1+	Feedback +	Connect to sensor feedback voltage output
	SEN1-	Feedback -	
CH3	EXC2+	Excitation +	Connect to sensor power supply input
	EXC2-	Excitation -	
	SIG2+	Signal +	Connect to sensor signal output
	SIG2-	Signal -	
	SEN2+	Feedback +	Connect to sensor feedback voltage output
	SEN2-	Feedback -	
CH4	EXC3+	Excitation +	Connect to sensor power supply input
	EXC3-	Excitation -	
	SIG3+	Signal +	Connect to sensor signal output
	SIG3-	Signal -	
	SEN3+	Feedback +	Connect to sensor feedback voltage output
	SEN3-	Feedback -	
-	L, N	Module power supply	Give power to module, AC220V \pm 10% 50/60Hz
	FG	Power supply ground	Connect to ground

12-3. External connection

Please use shield cable and single-point connect to the ground for shield layer.

Power supply wiring

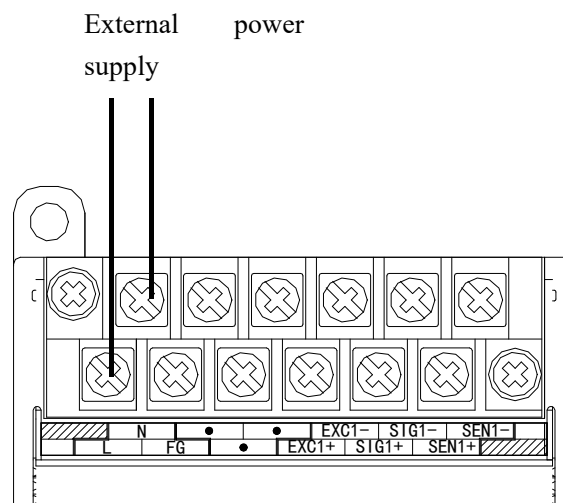

Connect to sensor

6 wires mode:

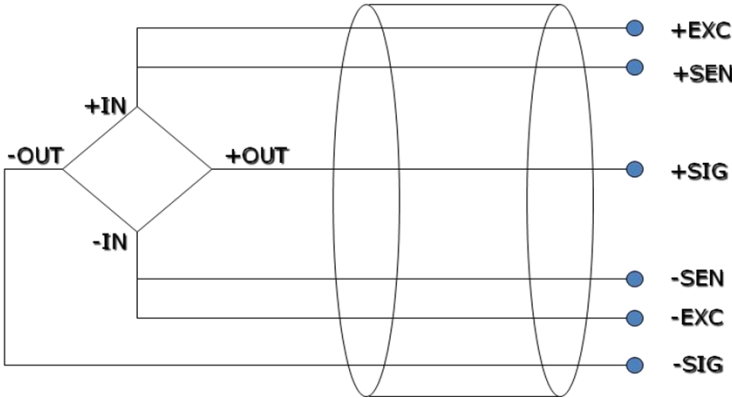

4 wires mode:

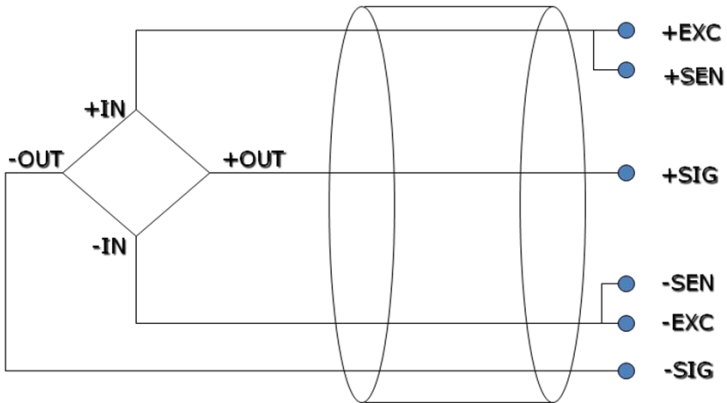

Note: short connect EXC1- and SEN1-, short connect EXC1+ and SEN1+ for 4 wires mode sensor.

12-4. Weighing system

A typical weighing system:

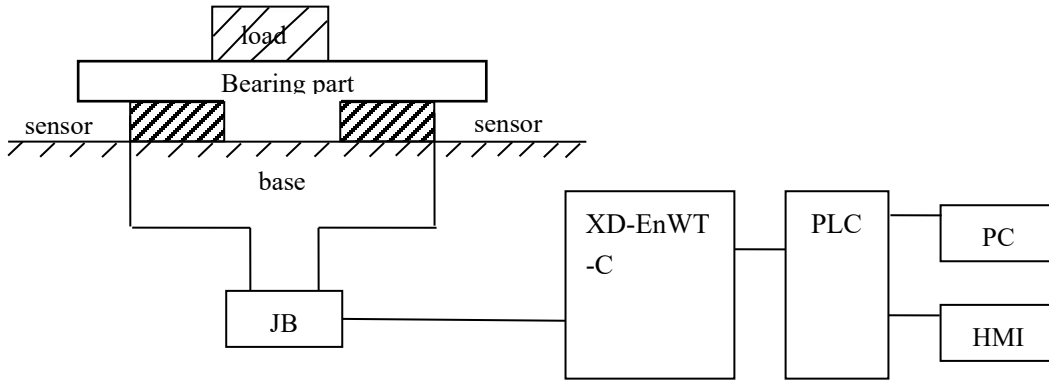

Loading bearing part: to support the load. Such as flat, hopper, container, air transport car...

Pressure sensor: transform the weight to voltage signal.

Assembly part: make sure the pressure sensor can work correctly, assembly part and direct part can avoid overload. Overload will cause measurement error and sensor damage.

Connection box (JB): to collect several sensor signals.

XD-EnWT-C: can be used as an electronic assessment device, it gets the pressure sensor signal and makes further assessment.

12-5. Module functions

XD-EnWT-C has the follow functions:

- Adjust the pressure sensor
- Collect the pressure sensor signal
- Calculate the weight value
- 0~10mV voltage signal test

12-5-1. Pressure sensor

The pressure sensor is based on resistance strain effect, see the following diagram:

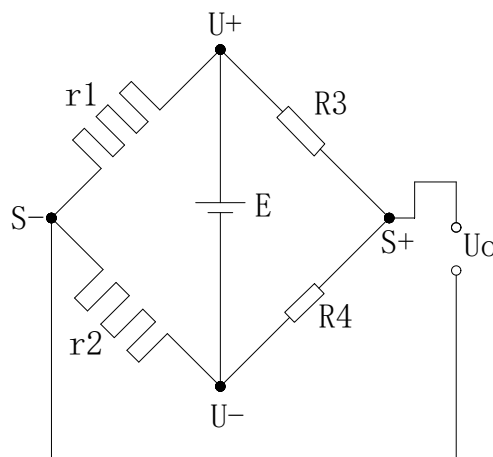

R1 and R2 is strain resistor which make bridge circuit with R3 and R4. With the change of R1 and R2, the

bridge circuit will lose the balance, unbalance voltage U_0 will be produced as the output of sensor.

U_+ and U_- are positive and negative point of the sensor power supply. Please select the 5V power of the module or from outside.

S_+ and S_- are positive and negative point of the sensor output. Connect the output to the module to test the weight.

12-6. I/O address

The I/O address of module 1:

Soft component		Address	Explanation	Note
Output coil	CH1	Y10000	Filter level	
		Y10001	Reset	
		Y10002	Zero point calibration	
		Y10003	Gain calibration	
	CH2	Y10004	Filter level	
		Y10005	Reset	
		Y10006	Zero point calibration	
		Y10007	Gain calibration	
	CH3	Y10010	Filter level	
		Y10011	Reset	
		Y10012	Zero point calibration	
		Y10013	Gain calibration	
	CH4	Y10014	Filter level	
		Y10015	Reset	
		Y10016	Zero point calibration	
		Y10017	Gain calibration	
	ALL	Y10020	Back to out of factory value	
Input coil	CH1	X10000	Stable flag	
		X10001	Overflow flag	
		X10002	Calibration success flag	
		X10003	Calibration failure flag	
	CH2	X10004	Stable flag	
		X10005	Overflow flag	
		X10006	Calibration success flag	
		X10007	Calibration failure flag	
	CH3	X10010	Stable flag	
		X10011	Overflow flag	
		X10012	Calibration success flag	
		X10013	Calibration failure flag	
	CH4	X10014	Stable flag	

		X10015	Overflow flag	
		X10016	Calibration success flag	
		X10017	Calibration failure flag	
Input register	CH1	ID10000	Present weight	Double words
		ID10002	Present digital value/present input voltage	Double words
	CH2	ID10004	Present weight	Double words
		ID10006	Present digital value/present input voltage	Double words
	CH3	ID10008	Present weight	Double words
		ID10010	Present digital value/present input voltage	Double words
	CH4	ID10012	Present weight	Double words
		ID10014	Present digital value/present input voltage	Double words

The I/O address of module 2:

Soft component		Address	Explanation	Note
Output coil	CH1	Y10100	Filter level	
		Y10101	Reset	
		Y10102	Zero point calibration	
		Y10103	Gain calibration	
	CH2	Y10104	Filter level	
		Y10105	Reset	
		Y10106	Zero point calibration	
		Y10107	Gain calibration	
	CH3	Y10110	Filter level	
		Y10111	Reset	
		Y10112	Zero point calibration	
		Y10113	Gain calibration	
	CH4	Y10114	Filter level	
		Y10115	Reset	
		Y10116	Zero point calibration	
		Y10117	Gain calibration	
	ALL	Y10120	Back to out of factory value	
Input coil	CH1	X10100	Stable flag	
		X10101	Overflow flag	
		X10102	Calibration success flag	
		X10103	Calibration failure flag	
	CH2	X10104	Stable flag	
		X10105	Overflow flag	
		X10106	Calibration success flag	
		X10107	Calibration failure flag	
	CH3	X10110	Stable flag	
X10111		Overflow flag		

		X10112	Calibration success flag	
		X10113	Calibration failure flag	
	CH4	X10114	Stable flag	
		X10115	Overflow flag	
		X10116	Calibration success flag	
		X10117	Calibration failure flag	
Input register	CH1	ID10100	Present weight	Double words
		ID10102	Present digital value/present input voltage	Double words
	CH2	ID10104	Present weight	Double words
		ID10106	Present digital value/present input voltage	Double words
	CH3	ID10108	Present weight	Double words
		ID10110	Present digital value/present input voltage	Double words
	CH4	ID10112	Present weight	Double words
		ID10114	Present digital value/present input voltage	Double words

.....

The I/O address of module 16:

Soft component		Address	Explanation	Note
Output coil	CH1	Y11500	Filter level	
		Y11501	Reset	
		Y11502	Zero point calibration	
		Y11503	Gain calibration	
	CH2	Y11504	Filter level	
		Y11505	Reset	
		Y11506	Zero point calibration	
		Y11507	Gain calibration	
	CH3	Y11510	Filter level	
		Y11511	Reset	
		Y11512	Zero point calibration	
		Y11513	Gain calibration	
	CH4	Y11514	Filter level	
		Y11515	Reset	
		Y11516	Zero point calibration	
		Y11517	Gain calibration	
	ALL	Y10020	Back to out of factory value	
Input coil	CH1	X11500	Stable flag	
		X11501	Overflow flag	
		X11502	Calibration success flag	
		X11503	Calibration failure flag	
	CH2	X11504	Stable flag	
		X11505	Overflow flag	
		X11506	Calibration success flag	

	CH3	X11507	Calibration failure flag	
		X11510	Stable flag	
		X11511	Overflow flag	
		X11512	Calibration success flag	
		X11513	Calibration failure flag	
	CH4	X11514	Stable flag	
		X11515	Overflow flag	
		X11516	Calibration success flag	
Input register	CH1	ID11500	Present weight	Double words
		ID11502	Present digital value/present input voltage	Double words
	CH2	ID11504	Present weight	Double words
		ID11506	Present digital value/present input voltage	Double words
	CH3	ID11508	Present weight	Double words
		ID11510	Present digital value/present input voltage	Double words
	CH4	ID11512	Present weight	Double words
		ID11514	Present digital value/present input voltage	Double words

Note: XD-E1WT-C has no CH2~CH4, XD-E2WT-C has no CH3~CH4.

Address explanation:

filter level	ON: filter level A, OFF: filter level B
Reset	The reset is valid in the reset range, not save zero point
zero point calibration	To calibrate the system zero point
gain calibration	To calibrate system linear
Stable flag	The signal output is effective when meeting the stable range and time
Overflow flag	When the signal voltage larger than 10mv, this signal output is effective
Calibration success flag	This signal output is effective when zero point calibration and gain calibration succeeded
Calibration failure flag	This signal output is effective when zero point calibration and gain calibration failed (the detailed reasons please check module applicatoin error info)
Present digital value/present input voltage	Switch through upper device, when it is switched to present input voltage, the unit is mv, the decimal place is 4 bits

12-7. Working mode

There are two method to set the working mode:

1. set through the control panel
2. set through Flash register

Open the XD PLC software, click the menu configure/expansion module setting.

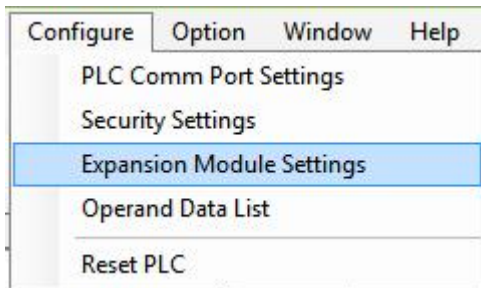

Choose the correct model and configuration information:

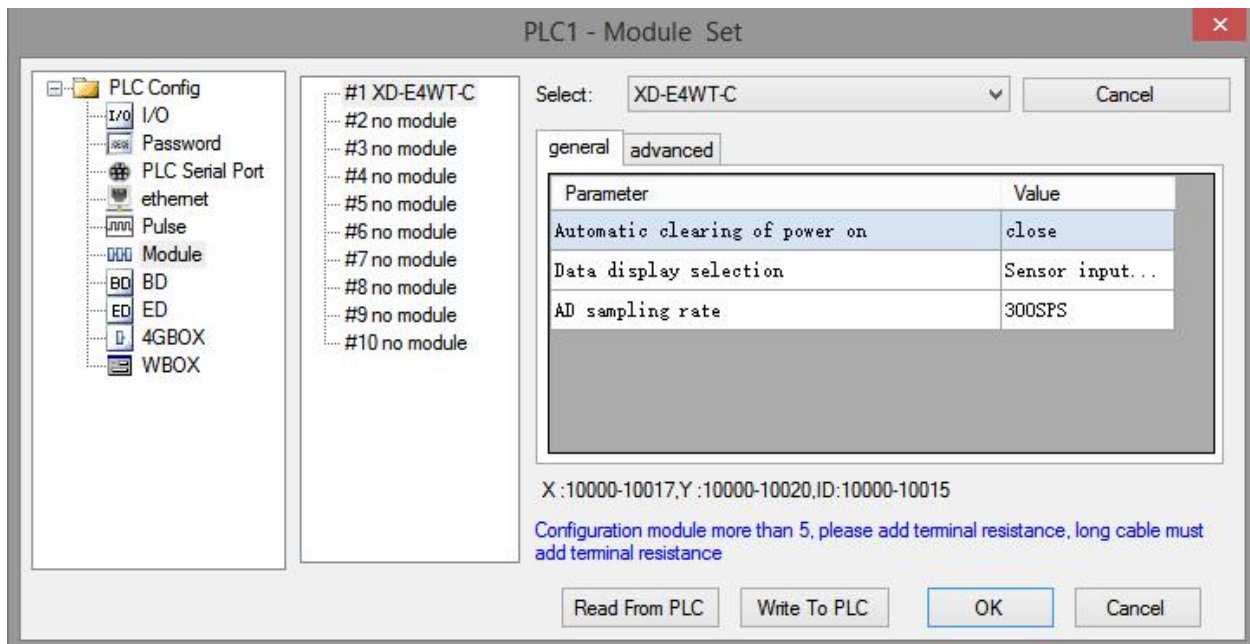

Flash register setting:

The expansion module can set the gear and user-defined fast sampling frequency through PLC flash register SFD.

Module no.	SFD address	Module no.	SFD address
#1	SFD350~SFD359	#9	SFD430~SFD439
#2	SFD360~SFD369	#10	SFD440~SFD449
#3	SFD370~SFD379	#11	SFD450~SFD459
#4	SFD380~SFD389	#12	SFD460~SFD469
#5	SFD390~SFD399	#13	SFD470~SFD479

#6	SFD400~SFD409	#14	SFD480~SFD489
#7	SFD410~SFD419	#15	SFD490~SFD499
#8	SFD420~SFD429	#16	SFD500~SFD509

SFD350~SFD359 register explanation:

SFD		Bit7	Bit6	Bit5	Bit4	Bit3	Bit2	Bit1	Bit0	NOTE
SFD350	Byte0	AD sampling speed Range 0~2 Initial value: 1 0: 150 time/second 1: 300 time/second 2: 450 time/second						Sampling data mode Initial value: 0 0: sensor input voltage (mv) 1: AD sampling digital value	Automatic reset when power on Initial value: 0 0: OFF 1: ON	
	Byte1	-								

12-8. Module setting

Module parameter list:

Address	Contents	Explanation		Features
K0	Zero point tracking range	Range: 0~9 Initial value: 5	All the channels	Word R/W
K1	Zero point tracking time	Range: 500~5000 (ms) Initial value: 2000		Word R/W
K2	Reset range	Range: 1~99 (%) Initial value: 50		Word R/W
K3	Stable range	Range: 1~99 Initial value: 3		Word R/W
K4	Stable time	Range: 10~5000 (ms) Initial value: 100		Word R/W
K5	Filter level A	Range: 0~9 Initial value: 3		Word R/W
K6	Filter level B	Range: 0~9 Initial value: 5		Word R/W

K7~K9	Reserved			
K10	Zero point calibration voltage return value	Return the present sensor input voltage after calibrating the zero point	CH1	Dword R
K12	Gain calibration digital value/gain calibration voltage return value	As weight input value for gain calibration. As return relative voltage for non-calibration		Dword R/W
K14	CH1 min scale division	Range: 1,2,5,10,20,50		Word R/W
K15	CH1 max range	Range: <1000000		Dword R/W
K17	Reserved			
K20	Zero calibration voltage return value	Return the present sensor input voltage after calibrating the zero point	CH2	Dword R
K22	Gain calibration value/gain calibration voltage return value	As weight input value for gain calibration. As return relative voltage for non-calibration		Dword R/W
K24	CH2 min scale division	Range: 1,2,5,10,20,50		Word R/W
K25	CH2 max range	Range: <1000000		Dword R/W
K27	Reserved			
K30	Zero calibration voltage return value	Return the present sensor input voltage after calibrating the zero point		Dword R
K32	Gain calibration value/gain calibration voltage return value	As weight input value for gain calibration. As return relative voltage for non-calibration	CH3	Dword R/W
K34	CH3 min scale division	Range: 1,2,5,10,20,50		Word R/W
K35	CH3 max range	Range: <1000000		Dword R/W
K37	Reserved			
K40	Zero calibration voltage return value	Return the present sensor input voltage after calibrating the zero point	CH4	Dword R
K42	Gain calibration value/gain calibration voltage return value	As weight input value for gain calibration. As return relative voltage for non-calibration		Dword R/W
K44	CH4 min scale division	Range: 1,2,5,10,20,50		Word R/W
K45	CH4 max range	Range: <1000000		Dword R/W
K47	Reserved			

Parameter notes:

1. Zero-point tracking range and time: If the weight value fluctuates in the range of K0 of zero point and the fluctuation lasts for K1 time, it is considered that the fluctuation value in this range is not recorded, and the weight value is displayed as 0.
2. Reset range: It is allowed to perform the reset action within the proportion range of the parameter maximum range.

3. Stable range and time: When the difference between the last weight value and the previous weight value is in K3 range and maintains K4 time, it is considered that the weight value at this time has been stable.

Take module no.1 as an example:

Weight unit setting:

Write in weight through instruction TO. For example, the object weight is 1kg, write in 1 means the unit is kg, write in 1000 means the unit is g, write in 10000 means the unit is 0.1g. resolution=1kg/write in digital value.

Calibration:

Please calibrate the pressure sensor for the first time using.

Take module channel 1 as an example:

1. confirm whether the module and sensor work properly.

Judgment method:

First, monitor whether the overflow flag X10001 is OFF state. If it is ON, the sensor is not connected or the sensor is damaged.

Second, using the software to monitor whether ID10002 value fluctuates following sensor (fluctuation range is related to sensor range), and pressure value increased when increasing the load, if there are value but increase the load stress value decreases, that means (1) sensor installed opposite, please adjust the sensor position or exchange +/- of sensor output signal; (2) The incoming voltage signal has been overflow, reducing the load appropriately.

2. Make the sensor no load, after the stable flag X10000 is ON, set ON zero-point calibration Y10002. X10002 ON means the zero-point calibration is successful. If after few seconds, X10003 is ON, that means zero-point calibration is failed.

3. Put the load whose weight is known on the scale, write the weight through TO instruction, after stable flag X10000 is ON, set ON gain calibration Y10003, X10002 ON means calibration is successful, shut off Y10003. If after few seconds, X10003 is ON, that means zero-point calibration is failed.

4. Hereto, the calibration finished. The module will automatic adjust the result according to the idle load value and calibration value when weighing, and finally get the correct weight.

12-9. Module error info

Serious application error (related to main unit register address SD503 high 8 bits)

Error code			Meaning
Binary	Hex	Decimal	
0000 0001	0x01	1	Not connect 24V
0000 0010	0x02	2	Not finish the setting in 5s
0000 0011	0x03	3	Module model is different
0000 0011	0x04	4	Communicate with PLC error

The error code using method: write in module no. in SD500, if it needs to check module no.1 error code, please write in 10000.

12-10. Instruction FROM and TO

The reading and writing of XD-EnWT-C module needs to be completed through the FROM/TO instruction in the sequential function block, as shown in the figure below:

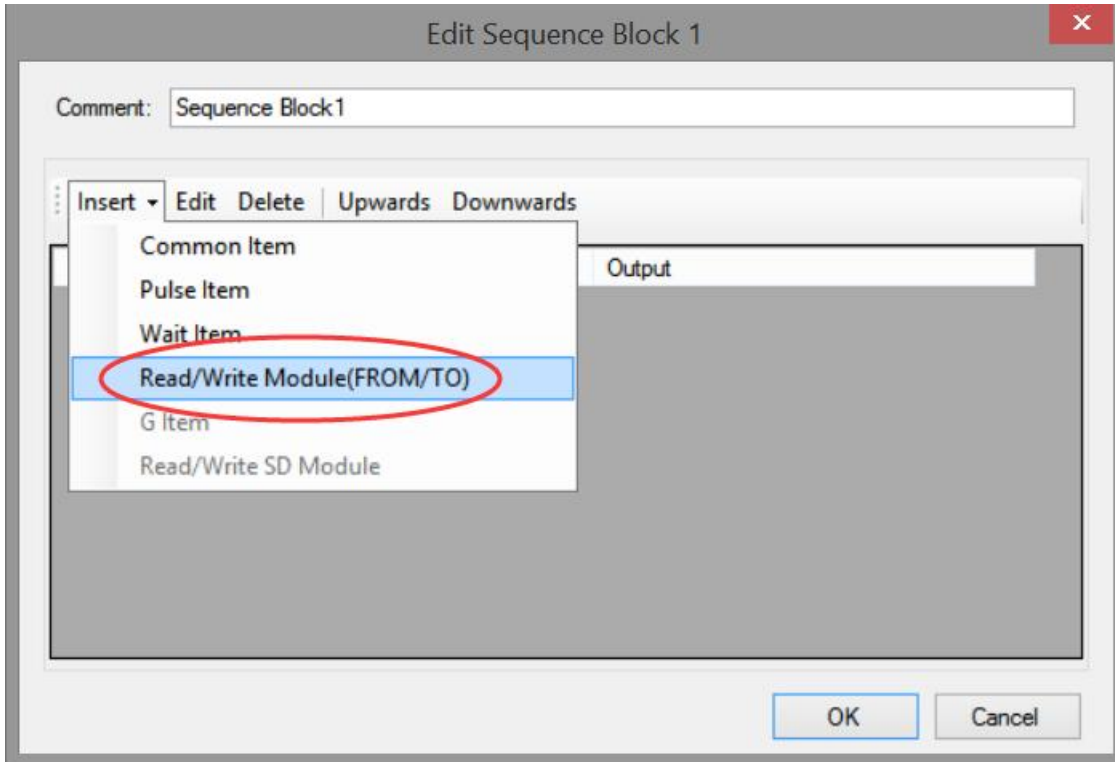

(a) Insert FROM/TO module

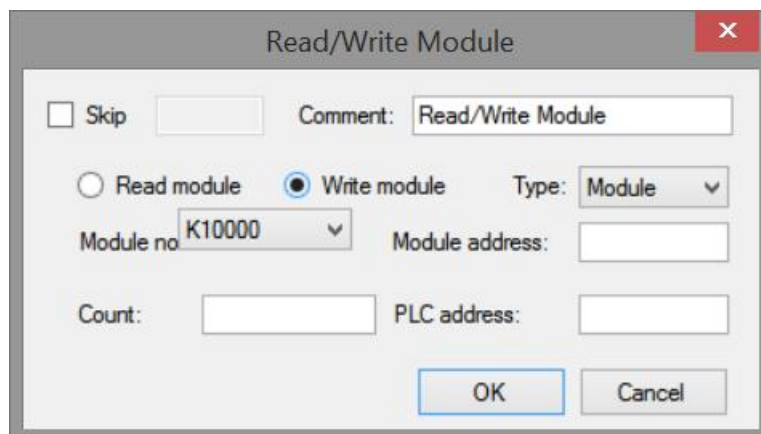

(b) Write instruction

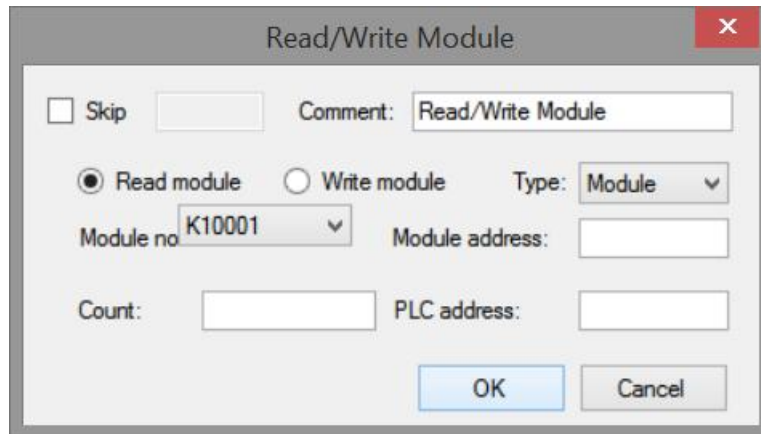

(c) Read instruction

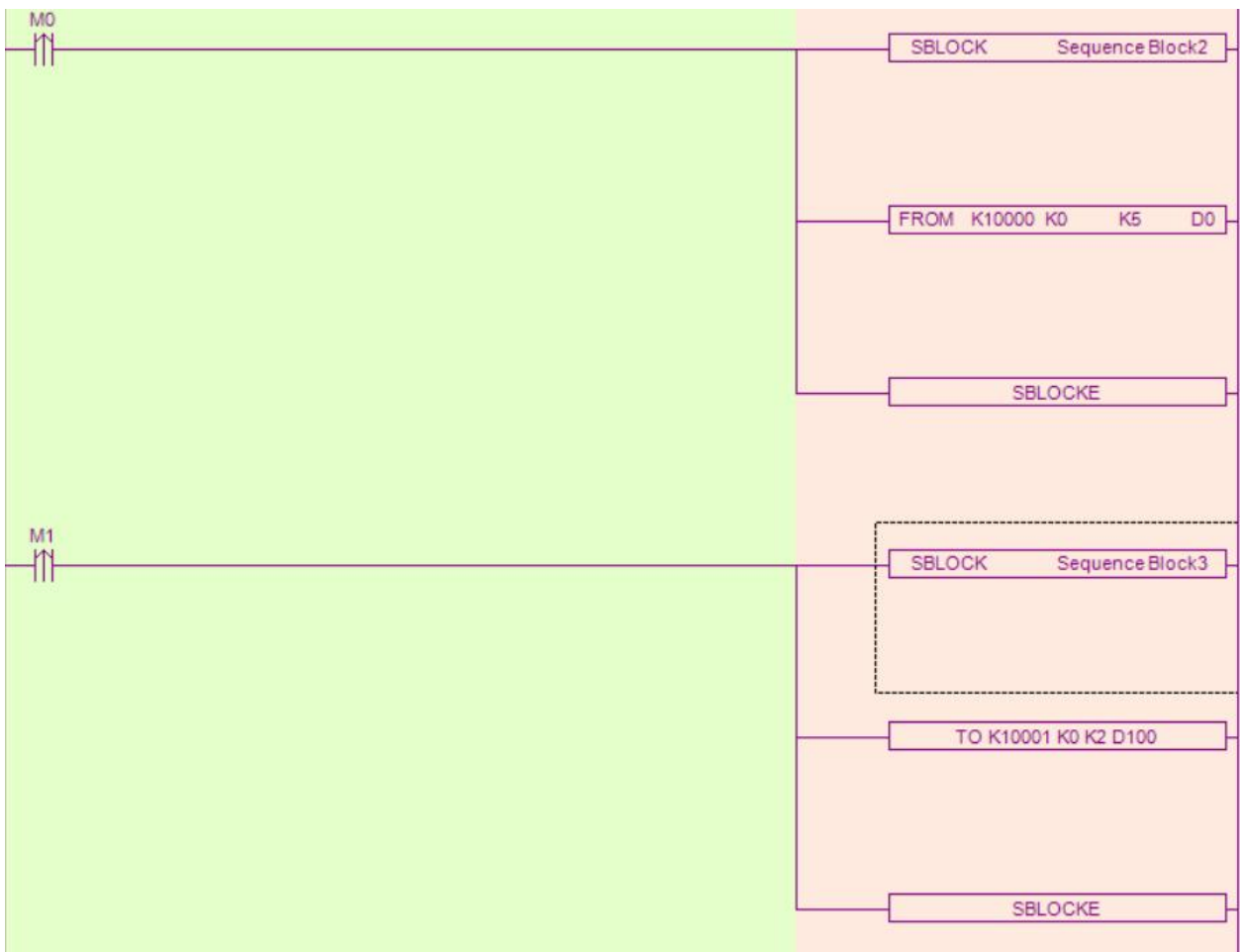

(d) Ladder chart

Write instruction TO

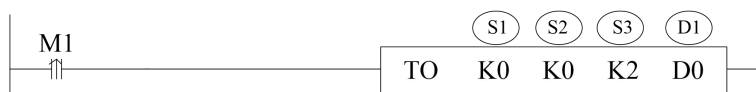

Function: write the PLC register data to module specified address, the unit is word.

Operand:

S1: target module number. Operand: K, TD, CD, D, HD, FD.

S2: module first address. Operand: K, TD, CD, D, HD, FD.

S3: write in register quantity. Operand: K, TD, CD, D, HD, FD.

D1: write in data register first address in PLC. Operand: TD, CD, D, HD, FD.

Example: write the weight value to module no.1 channel 1

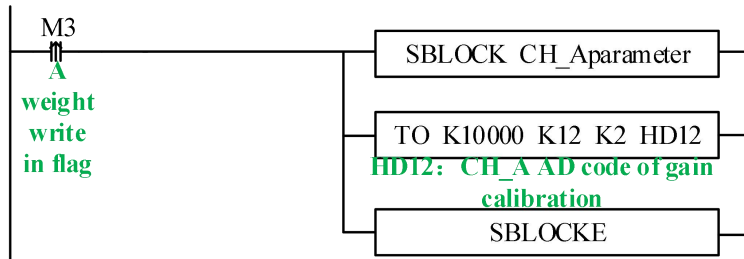

Read instruction FROM



Function: read the module data to PLC register, the unit is word.

Operand:

S1: target module number. Operand: K, TD, CD, D, HD, FD.

S2: module first address. Operand: K, TD, CD, D, HD, FD.

S3: read register quantity. Operand: K, TD, CD, D, HD, FD.

D1: PLC register first address. Operand: TD, CD, D, HD, FD.

For example: read all the parameters of module no.1

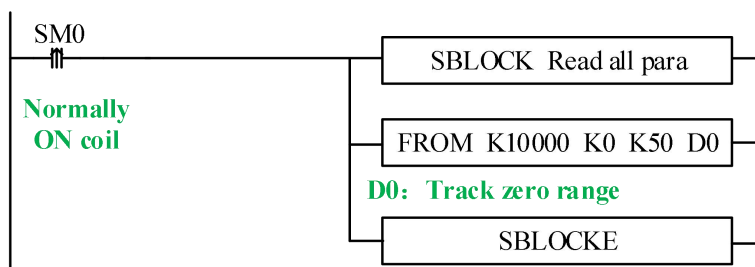

Note:

1. From/TO instruction can only be written in sequence function block, XD series PLC with firmware version less than v3.4.5 only allows up to 8 function blocks; XD/XL series PLC with firmware version v3.4.5 and above can write up to 100 blocks in the program, but can only run up to 8 blocks at the same time.
2. The starting number of module starts from k10000, k10000 is module 1 and k10001 is module 2. By analogy, module 16 is K10015.

12-11. AD transformation diagram

The relationship between input voltage and transformed digital value is shown as below:

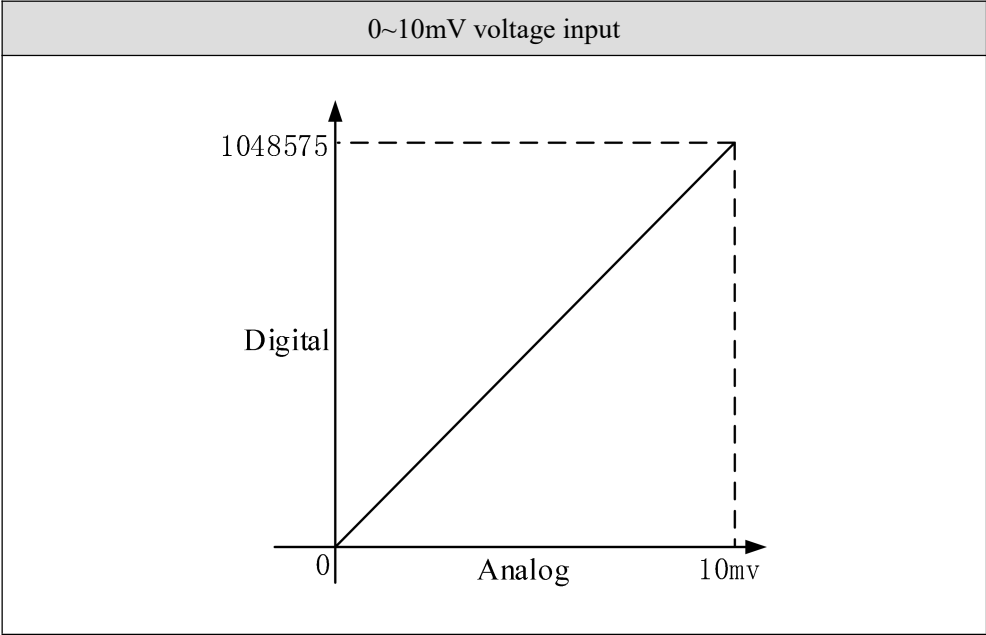

12-12. Application program

Take module 1 as an example:

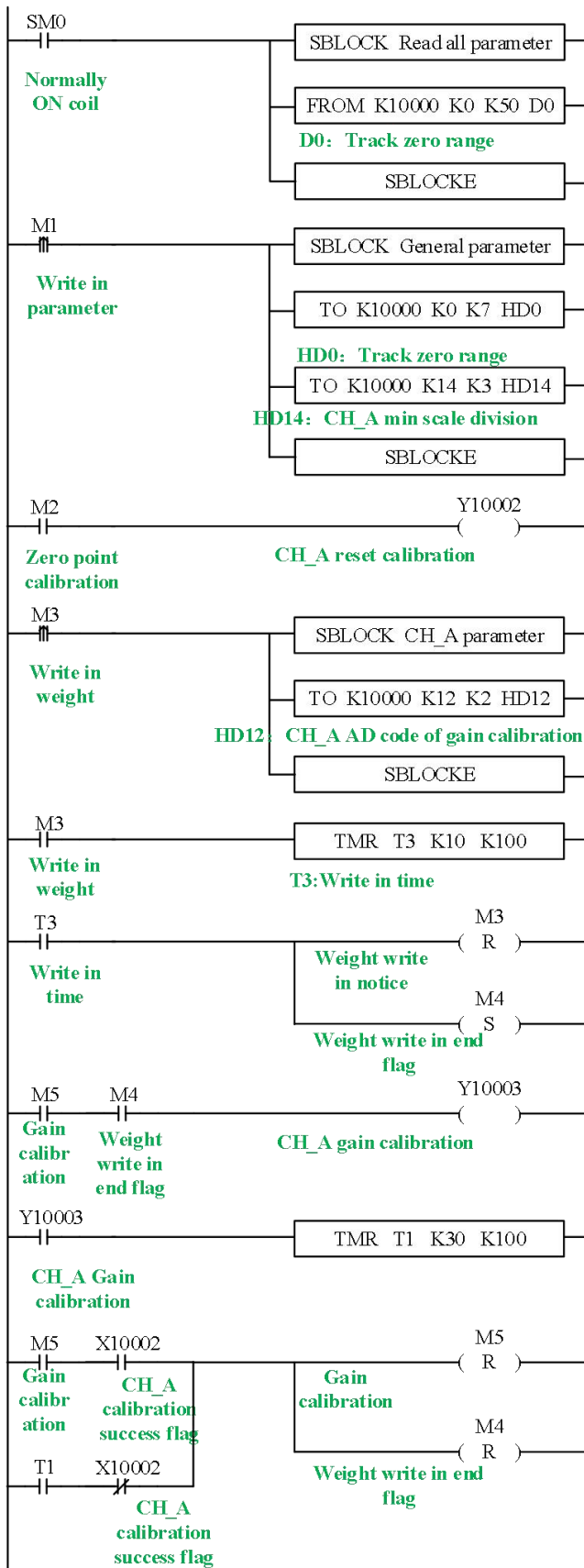

Explanation:

Read all the parameters and write in general parameters through FROM/TO instruction.

Set ON M1, write in all the parameters of channel 1.

Zero-point calibration: set ON M2, if zero-point calibration is successful, X10002 is set ON.

Gain calibration: first set ON M3, write the weight value HD12 to the module. After write in success flag M4 is ON, it starts to calibrate gain. Set ON M5 to start the calibration, the preset stable time is 3s. after the scale is stable, gain calibration success flag X10002 is ON or calibration time T1 reached, reset M4, M5, gain calibration is finished.

13. N channels pressure module XD-EnWT-D

13-1. Features

This chapter mainly introduces XD-E1WT-D, XD-E2WT-D, XD-E4WT-D module specifications, terminal description, system composition, module functions and parameters, external connections, analog-to-digital conversion diagram and related programming examples.

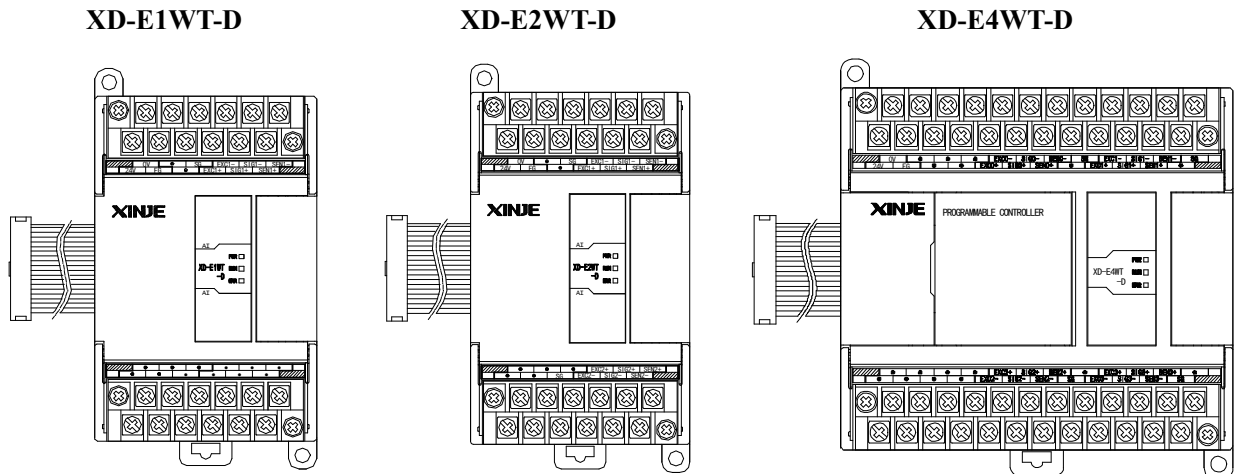

Features:

The 1, 2, 4 channels of pressure measurement module XD-EnWT-C, as an extension module of XD series PLC, can be used to detect the voltage signal of $-20\sim 20\text{mV}$ or collect the voltage signal of pressure sensor, and convert the analog voltage value into digital value through A/D and carry out operation.

- The analog voltage signal of 1 / 2 / 4 channel pressure sensor can be collected.
- It can detect the voltage signal of $-20\sim 20\text{mV}$.

- 23-bit high precision A / D conversion.
- As a special function module of XD series, XD3/XD3E can connect up to 10 modules on the right side of PLC main unit, XD5/XDM/XDC/XD5E/XDME/XDH can expand 16 modules, XD1/XD2 does not support expansion modules.

Specifications:

Input range	DC -20~20mV
AD real resolution	1/8388607 (23Bit)
Max display resolution	1/500000
Non-linear	0.01%F.S
Transformation speed	150/300/450 times/second (optional)
Power supply	DC24V ± 10%
Sensor power supply	5VDC/120mA, can parallel 4 pieces of 350Ω pressure sensor
Dimension	63mm×108mm×89.9mm (XD-E1/2WT-D) 108.6×108mm×89.9mm (XD-E4WT-D)
Installation	Mount on DIN46277 rail (width 35mm) or fix with screw M3
Software version	V3.5.3 and higher version
Working environment	No corrosive gas
Ambient temperature	-10°C~50°C
Humidity	5~95%RH (no condensation)

13-2. Terminals

XD-E1WT-D:

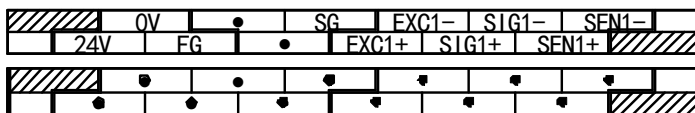

XD-E2WT-D:

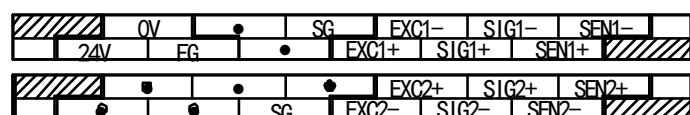

XD-E4WT-D:

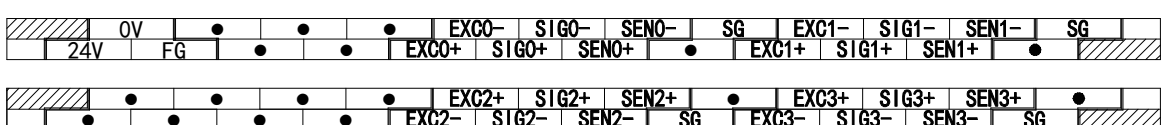

XD-E1WT-D:

Channel	Terminal	Signal	Meaning
CH1	EXC1+	Excitation +	Connect to sensor power supply input
	EXC1-	Excitation -	
	SIG1+	Signal +	Connect to sensor signal output
	SIG1-	Signal -	
	SEN1+	Feedback +	Connect to sensor feedback voltage output
	SEN1-	Feedback -	
	SG	Signal ground	Connect to the ground
-	24V, 0V	Module power supply	Give power to module, DC24V \pm 10%
	FG	Power supply ground	Connect to ground

XD-E2WT-D:

Channel	Terminal	Signal	Meaning
CH1	EXC1+	Excitation +	Connect to sensor power supply input
	EXC1-	Excitation -	
	SIG1+	Signal +	Connect to sensor signal output
	SIG1-	Signal -	
	SEN1+	Feedback +	Connect to sensor feedback voltage output
	SEN1-	Feedback -	
	SG	Signal ground	Connect to the ground
CH2	EXC2+	Excitation +	Connect to sensor power supply input
	EXC2-	Excitation -	
	SIG2+	Signal +	Connect to sensor signal output
	SIG2-	Signal -	
	SEN2+	Feedback +	Connect to sensor feedback voltage output
	SEN2-	Feedback -	
	SG	Signal ground	Connect to the ground
-	24V, 0V	Module power supply	Give power to module, DC24V \pm 10%
	FG	Power supply ground	Connect to ground

XD-E4WT-D:

Channel	Terminal	Signal	Meaning
CH1	EXC0+	Excitation +	Connect to sensor power supply input
	EXC0-	Excitation -	
	SIG0+	Signal +	Connect to sensor signal output
	SIG0-	Signal -	
	SEN0+	Feedback +	Connect to sensor feedback voltage

	SEN0-	Feedback -	output
	SG	Signal ground	Connect to the ground
CH2	EXC1+	Excitation +	Connect to sensor power supply input
	EXC1-	Excitation -	
	SIG1+	Signal +	Connect to sensor signal output
	SIG1-	Signal -	
	SEN1+	Feedback +	Connect to sensor feedback voltage output
	SEN1-	Feedback -	
	SG	Signal ground	Connect to the ground
CH3	EXC2+	Excitation +	Connect to sensor power supply input
	EXC2-	Excitation -	
	SIG2+	Signal +	Connect to sensor signal output
	SIG2-	Signal -	
	SEN2+	Feedback +	Connect to sensor feedback voltage output
	SEN2-	Feedback -	
	SG	Signal ground	Connect to the ground
CH4	EXC3+	Excitation +	Connect to sensor power supply input
	EXC3-	Excitation -	
	SIG3+	Signal +	Connect to sensor signal output
	SIG3-	Signal -	
	SEN3+	Feedback +	Connect to sensor feedback voltage output
	SEN3-	Feedback -	
	SG	Signal ground	Connect to the ground
-	24V, 0V	Module power supply	Give power to module, DC24V \pm 10%
	FG	Power supply ground	Connect to ground

13-3. External connection

Please use shield cable and single-point connect to the ground for shield layer.

Power supply wiring

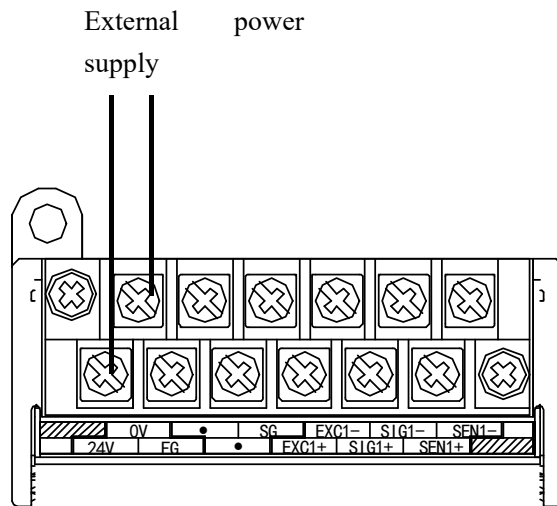

Connect to sensor

6 wires mode:

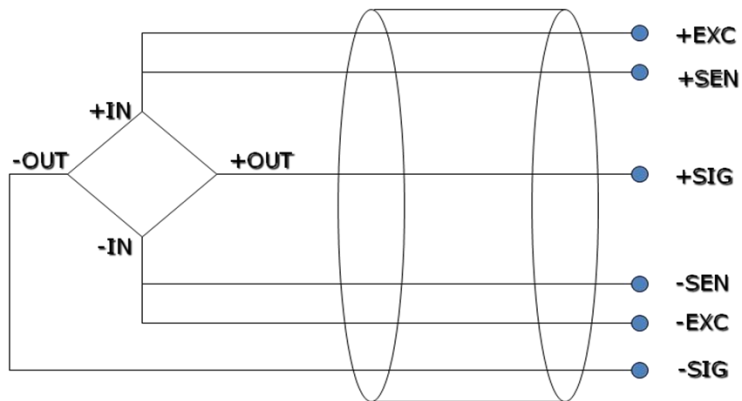

4 wires mode:

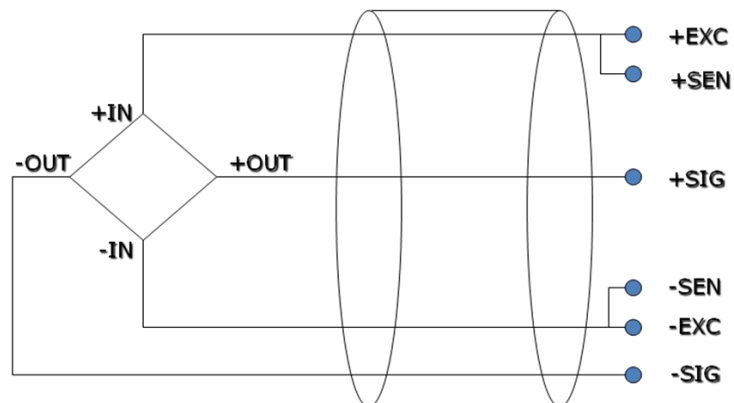

Note: short connect EXC1- and SEN1-, short connect EXC1+ and SEN1+ for 4 wires mode sensor.

13-4. Weighing system

A typical weighing system:

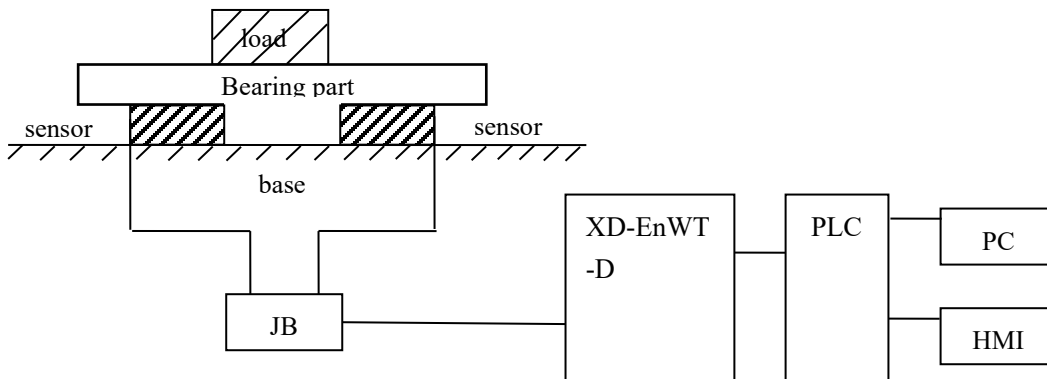

Loading bearing part: to support the load. Such as flat, hopper, container, air transport car...

Pressure sensor: transform the weight to voltage signal.

Assembly part: make sure the pressure sensor can work correctly, assembly part and direct part can avoid overload. Overload will cause measurement error and sensor damage.

Connection box (JB): to collect several sensor signals.

XD-EnWT-D: can be used as an electronic assessment device, it gets the pressure sensor signal and makes further assessment.

13-5. Module functions

XD-EnWT-D has the follow functions:

- Adjust the pressure sensor
- Collect the pressure sensor signal
- Calculate the weight value
- -20~20mV voltage signal test

13-5-1. Pressure sensor

The pressure sensor is based on resistance strain effect, see the following diagram:

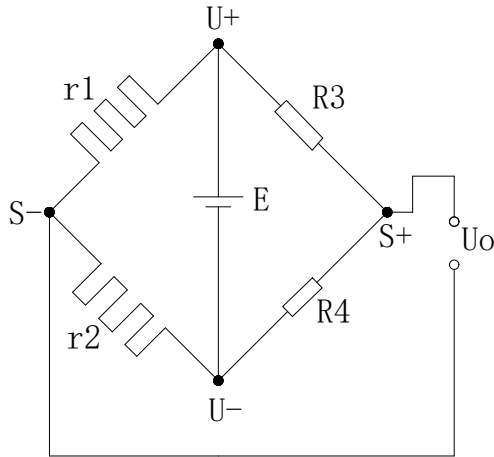

R1 and R2 is strain resistor which make bridge circuit with R3 and R4. With the change of R1 and R2, the bridge circuit will lose the balance, unbalance voltage U_o will be produced as the output of sensor.

$U+$ and $U-$ are positive and negative point of the sensor power supply. Please select the 5V power of the module or from outside.

$S+$ and $S-$ are positive and negative point of the sensor output. Connect the output to the module to test the weight.

13-6. I/O address

The I/O address of module 1:

Soft component		Address	Explanation	Note
Output coil	CH1	Y10000	Filter level	
		Y10001	Reset	
		Y10002	Zero point calibration	
		Y10003	Gain calibration	
	CH2	Y10004	Filter level	
		Y10005	Reset	
		Y10006	Zero point calibration	
		Y10007	Gain calibration	
	CH3	Y10010	Filter level	
		Y10011	Reset	
		Y10012	Zero point calibration	
		Y10013	Gain calibration	
	CH4	Y10014	Filter level	
		Y10015	Reset	
		Y10016	Zero point calibration	
		Y10017	Gain calibration	
	ALL	Y10020	Back to out of factory value	

Input coil	CH1	X10000	Stable flag	
		X10001	Overflow flag	
		X10002	Calibration success flag	
		X10003	Calibration failure flag	
		X10020	AD update flag	
	CH2	X10004	Stable flag	
		X10005	Overflow flag	
		X10006	Calibration success flag	
		X10007	Calibration failure flag	
		X10021	AD update flag	
	CH3	X10010	Stable flag	
		X10011	Overflow flag	
		X10012	Calibration success flag	
		X10013	Calibration failure flag	
		X10022	AD update flag	
	CH4	X10014	Stable flag	
		X10015	Overflow flag	
		X10016	Calibration success flag	
		X10017	Calibration failure flag	
		X10023	AD update flag	
Input register	CH1	ID10000	Present weight	Double words
		ID10002	Present digital value/present input voltage	Double words
	CH2	ID10004	Present weight	Double words
		ID10006	Present digital value/present input voltage	Double words
	CH3	ID10008	Present weight	Double words
		ID10010	Present digital value/present input voltage	Double words
	CH4	ID10012	Present weight	Double words
		ID10014	Present digital value/present input voltage	Double words

The I/O address of module 2:

Soft component		Address	Explanation	Note
Output coil	CH1	Y10100	Filter level	
		Y10101	Reset	
		Y10102	Zero point calibration	
		Y10103	Gain calibration	
	CH2	Y10104	Filter level	
		Y10105	Reset	
		Y10106	Zero point calibration	
		Y10107	Gain calibration	
	CH3	Y10110	Filter level	
		Y10111	Reset	

		Y10112	Zero point calibration	
		Y10113	Gain calibration	
	CH4	Y10114	Filter level	
		Y10115	Reset	
		Y10116	Zero point calibration	
		Y10117	Gain calibration	
	ALL	Y10120	Back to out of factory value	
Input coil	CH1	X10100	Stable flag	
		X10101	Overflow flag	
		X10102	Calibration success flag	
		X10103	Calibration failure flag	
		X10120	AD update flag	
	CH2	X10104	Stable flag	
		X10105	Overflow flag	
		X10106	Calibration success flag	
		X10107	Calibration failure flag	
		X10121	AD update flag	
	CH3	X10110	Stable flag	
		X10111	Overflow flag	
		X10112	Calibration success flag	
		X10113	Calibration failure flag	
		X10122	AD update flag	
	CH4	X10114	Stable flag	
		X10115	Overflow flag	
		X10116	Calibration success flag	
		X10117	Calibration failure flag	
		X10123	AD update flag	
Input register	CH1	ID10100	Present weight	Double words
		ID10102	Present digital value/present input voltage	Double words
	CH2	ID10104	Present weight	Double words
		ID10106	Present digital value/present input voltage	Double words
	CH3	ID10108	Present weight	Double words
		ID10110	Present digital value/present input voltage	Double words
	CH4	ID10112	Present weight	Double words
		ID10114	Present digital value/present input voltage	Double words

.....

The I/O address of module 16:

Soft component		Address	Explanation	Note
Output coil	CH1	Y11500	Filter level	
		Y11501	Reset	
		Y11502	Zero point calibration	
		Y11503	Gain calibration	
	CH2	Y11504	Filter level	
		Y11505	Reset	
		Y11506	Zero point calibration	
		Y11507	Gain calibration	
	CH3	Y11510	Filter level	
		Y11511	Reset	
		Y11512	Zero point calibration	
		Y11513	Gain calibration	
	CH4	Y11514	Filter level	
		Y11515	Reset	
		Y11516	Zero point calibration	
		Y11517	Gain calibration	
	ALL	Y10020	Back to out of factory value	
Input coil	CH1	X11500	Stable flag	
		X11501	Overflow flag	
		X11502	Calibration success flag	
		X11503	Calibration failure flag	
		X11520	AD update flag	
	CH2	X11504	Stable flag	
		X11505	Overflow flag	
		X11506	Calibration success flag	
		X11507	Calibration failure flag	
		X11521	AD update flag	
	CH3	X11510	Stable flag	
		X11511	Overflow flag	
		X11512	Calibration success flag	
		X11513	Calibration failure flag	
		X11522	AD update flag	
	CH4	X11514	Stable flag	
		X11515	Overflow flag	
		X11516	Calibration success flag	
		X11517	Calibration failure flag	
		X11523	AD update flag	
Input register	CH1	ID11500	Present weight	Double words
		ID11502	Present digital value/present input voltage	Double words
	CH2	ID11504	Present weight	Double words

		ID11506	Present digital value/present input voltage	Double words
	CH3	ID11508	Present weight	Double words
		ID11510	Present digital value/present input voltage	Double words
	CH4	ID11512	Present weight	Double words
		ID11514	Present digital value/present input voltage	Double words

Note: XD-E1WT-D has no CH2~CH4, XD-E2WT-D has no CH3~CH4.

Address explanation:

filter level	ON: filter level A, OFF: filter level B
Reset	The reset is valid in the reset range, not save zero point
zero point calibration	To calibrate the system zero point
gain calibration	To calibrate system linear
Stable flag	The signal output is effective when meeting the stable range and time
Overflow flag	When the signal voltage larger than 10mv, this signal output is effective
Calibration success flag	This signal output is effective when zero point calibration and gain calibration succeeded
Calibration failure flag	This signal output is effective when zero point calibration and gain calibration failed (the detailed reasons please check module applicatoin error info)
Present digital value/present input voltage	Switch through upper device, when it is switched to present input voltage, the unit is mv, the decimal place is 4 bits

13-7. Working mode

There are two methods to set the working mode:

1. set through the control panel
2. set through Flash register

Open the XD PLC software, click the menu configure/expansion module setting.

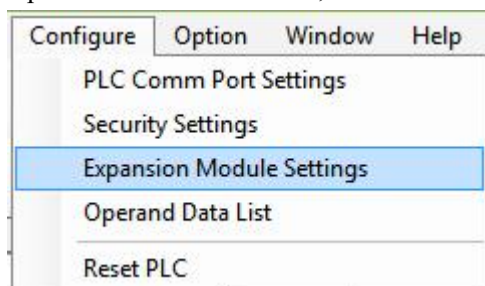

Choose the correct model and configuration information:

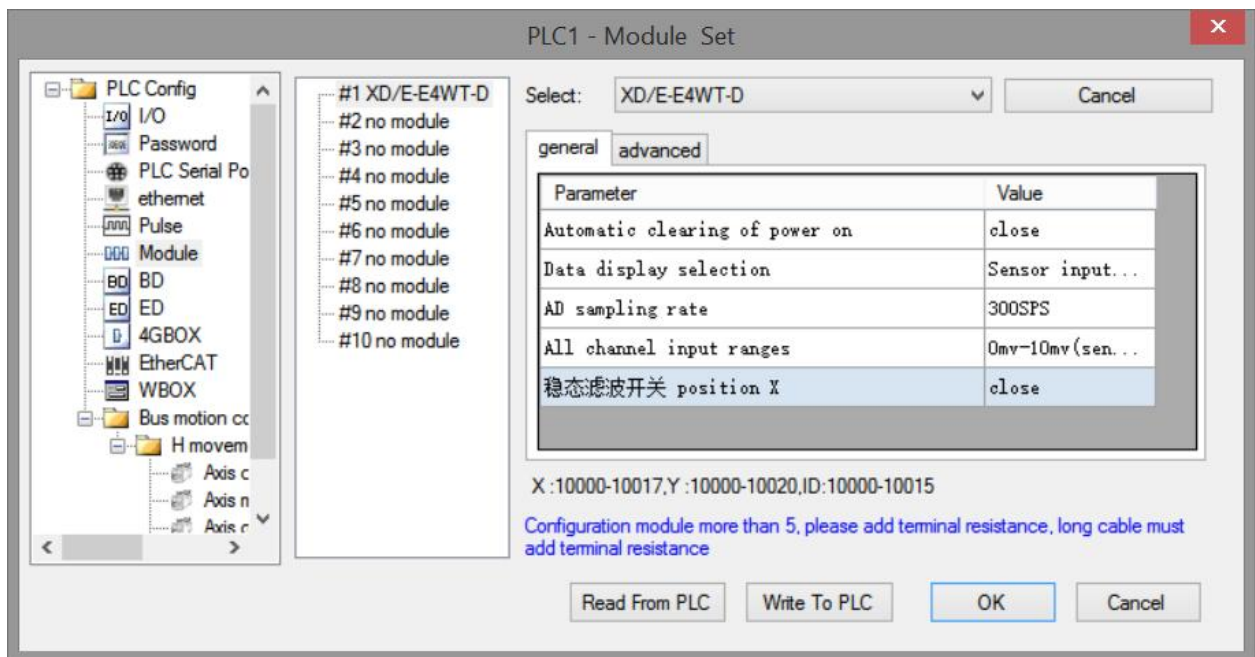

Parameter	Function
Automatic clearing of power on	After opening, the module will be reset automatically every time it is powered on.
Data display selection	Configuration switching can be performed. When switching to the current input voltage, the unit is mV and the decimal point is 4 digits;
AD sampling rate	Select AD sampling speed
All channel input ranges	Support -20~20mV voltage signal detection, can choose the range according to the demand
Steady state filter switch	Steady state filter switch, when set to off, the steady-state filter coefficient can be written, but it is invalid. When set to on, it is valid in steady state.

Flash register setting:

The expansion module can set the gear and user-defined fast sampling frequency through PLC flash register SFD.

Module no.	SFD address	Module no.	SFD address
#1	SFD350~SFD359	#9	SFD430~SFD439
#2	SFD360~SFD369	#10	SFD440~SFD449
#3	SFD370~SFD379	#11	SFD450~SFD459
#4	SFD380~SFD389	#12	SFD460~SFD469

#5	SFD390~SFD399	#13	SFD470~SFD479
#6	SFD400~SFD409	#14	SFD480~SFD489
#7	SFD410~SFD419	#15	SFD490~SFD499
#8	SFD420~SFD429	#16	SFD500~SFD509

SFD350~SFD359 register explanation:

SFD		Bit7	Bit6	Bit5	Bit4	Bit3	Bit2	Bit1	Bit0	NOTE
SFD350	Byte0	AD sampling speed Range 0~2 Initial value: 1 0: 150 time/second 1: 300 time/second 2: 450 time/second				Steady state filtering 0: OFF 1: ON		Sampling data mode Initial value: 0 0: sensor input voltage (mv) 1: AD sampling digital value	Automatic reset when power on Initial value: 0 0: OFF 1: ON	All the channels
	Byte1	-								

13-8. Module setting

Module parameter list:

Address	Contents	Explanation		Features
K0	Zero point tracking range	Range: 0~9 Initial value: 5	All the channels	Word R/W
K1	Zero point tracking time	Range: 10~5000 (ms) Initial value: 2000		Word R/W
K2	Reset range	Range: 1~99 (%) Initial value: 50		Word R/W
K3	Stable range	Range: 1~99 Initial value: 3		Word R/W
K4	Stable time	Range: 10~5000 (ms) Initial value: 100		Word R/W

K5	Filter level A	Range: 0~34 Initial value: 3		Word R/W
K6	Filter level B	Range: 0~34 Initial value: 5		Word R/W
K8	Steady state filter coefficient	Range: 0~34 Initial value: 0		Word R/W
K9	-			
K10	Return value of relative digital quantity in gain calibration	Gain calibration digital vlaue-zero-point Calibration digital value	CH1	Dword R
K12	Gain calibration weight value	Gain calibration weight value		Dword R/W
K14	CH1 min scale division	Range: 1,2,5,10,20,50		Word R/W
K15	CH1 max range	Range: $\leq \text{division} \times 500000$		Dword R/W
K20	Return value of relative digital quantity in gain calibration	Gain calibration digital vlaue-zero-point Calibration digital value	CH2	Dword R
K22	Gain calibration weight value	Gain calibration weight value		Dword R/W
K24	CH2 min scale division	Range: 1,2,5,10,20,50		Word R/W
K25	CH2 max range	Range: $\leq \text{division} \times 500000$		Dword R/W
K27	Reserved			
K30	Return value of relative digital quantity in gain calibration	Gain calibration digital vlaue-zero-point Calibration digital value		Dword R
K32	Gain calibration weight value	Gain calibration weight value	CH3	Dword R/W
K34	CH3 min scale division	Range: 1,2,5,10,20,50		Word R/W
K35	CH3 max range	Range: $\leq \text{division} \times 500000$		Dword R/W
K40	Return value of relative digital quantity in gain calibration	Gain calibration digital vlaue-zero-point Calibration digital value	CH4	Dword R
K42	Gain calibration weight value	Gain calibration weight value		Dword R/W
K44	CH4 min scale division	Range: 1,2,5,10,20,50		Word R/W
K45	CH4 max range	Range: $\leq \text{division} \times 500000$		Dword R/W
K47	Reserved			

Parameter notes:

1. Zero-point tracking range and time: If the weight value fluctuates in the range of K0 of zero point and the fluctuation lasts for K1 time, it is considered that the fluctuation value in this range is not recorded, and the weight value is displayed as 0.
2. Reset range: It is allowed to perform the reset action within the proportion range of the parameter maximum range.

3. Stable range and time: When the difference between the last weight value and the previous weight value is in K3 range and maintains K4 time, it is considered that the weight value at this time has been stable.

Take module no.1 as an example:

Weight unit setting:

Write in weight through instruction TO. For example, the object weight is 1kg, write in 1 means the unit is kg, write in 1000 means the unit is g, write in 10000 means the unit is 0.1g. resolution=1kg/write in digital value.

Calibration:

Please calibrate the pressure sensor for the first time using.

Take module channel 1 as an example:

Step 1:

Confirm whether the module and sensor work properly.

Judgment method:

First, monitor whether the overflow flag X10001 is OFF state. If it is ON, the sensor is not connected or the sensor is damaged.

Second, using the software to monitor whether ID10002 value fluctuates following sensor (fluctuation range is related to sensor range), and pressure value increased when increasing the load, if there are value but increase the load stress value decreases, that means (1) sensor installed opposite, please adjust the sensor position or exchange +/- of sensor output signal; (2) The incoming voltage signal has been overflow, reducing the load appropriately.

Step 2:

Make the sensor no load, after the stable flag X10000 is ON, set ON zero-point calibration Y10002. X10002 ON means the zero-point calibration is successful. If after few seconds, X10003 is ON, that means zero-point calibration is failed.

Step 3:

Put the load whose weight is known on the scale, write the weight through TO instruction, after stable flag X10000 is ON, set ON gain calibration Y10003, X10002 ON means calibration is successful, shut off Y10003. If after few seconds, X10003 is ON, that means zero-point calibration is failed.

Step 4:

Hereto, the calibration finished. The module will automatic adjust the result according to the idle load value and calibration value when weighing, and finally get the correct weight.

13-9. Module error info

Serious application error (related to main unit register address SD503 high 8 bits)

Error code			Meaning
Binary	Hex	Decimal	
0000 0001	0x01	1	Not connect 24V
0000 0010	0x02	2	Not finish the setting in 5s
0000 0011	0x03	3	Module model is different

0000 0011	0x04	4	Communicate with PLC error
-----------	------	---	----------------------------

The error code using method: write in module no. in SD500, if it needs to check module no.1 error code, please write in 10000.

13-10. Instruction FROM and TO

The reading and writing of XD-EnWT-D module needs to be completed through the FROM/TO instruction in the sequential function block, as shown in the figure below:

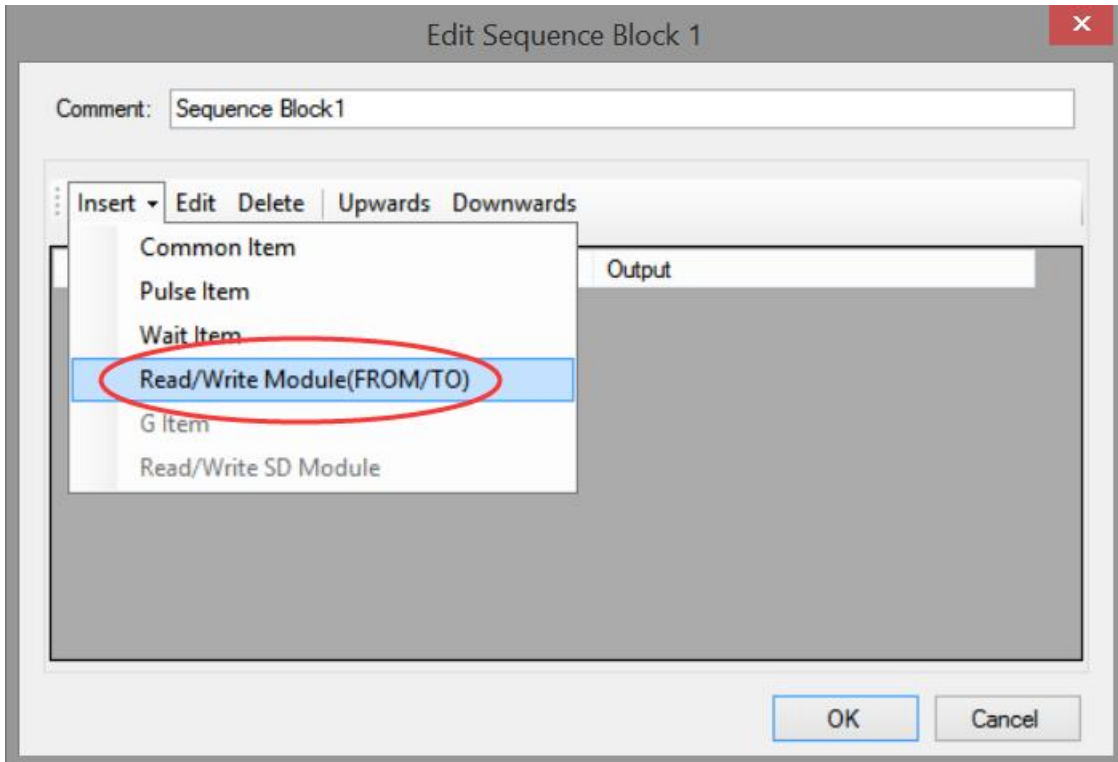

(e) Insert FROM/TO module

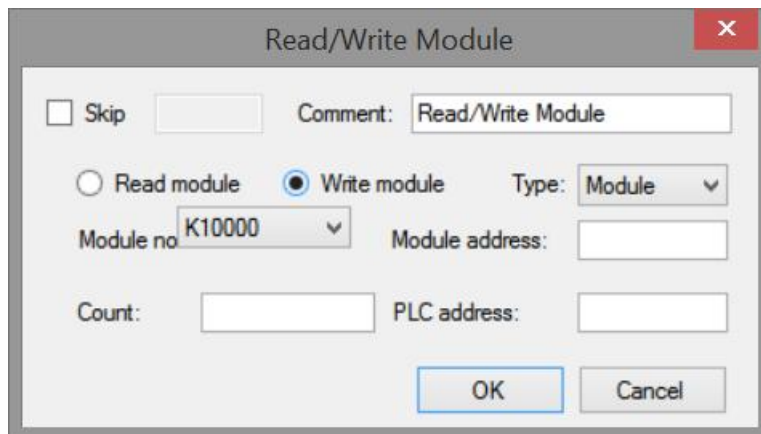

(f) Write instruction

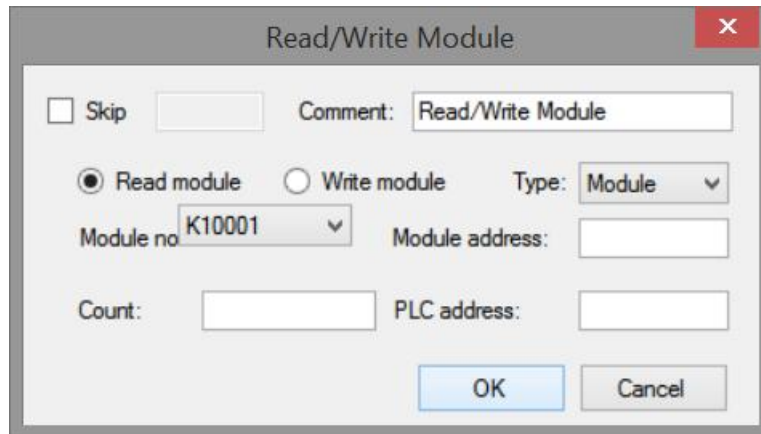

(g) Read instruction

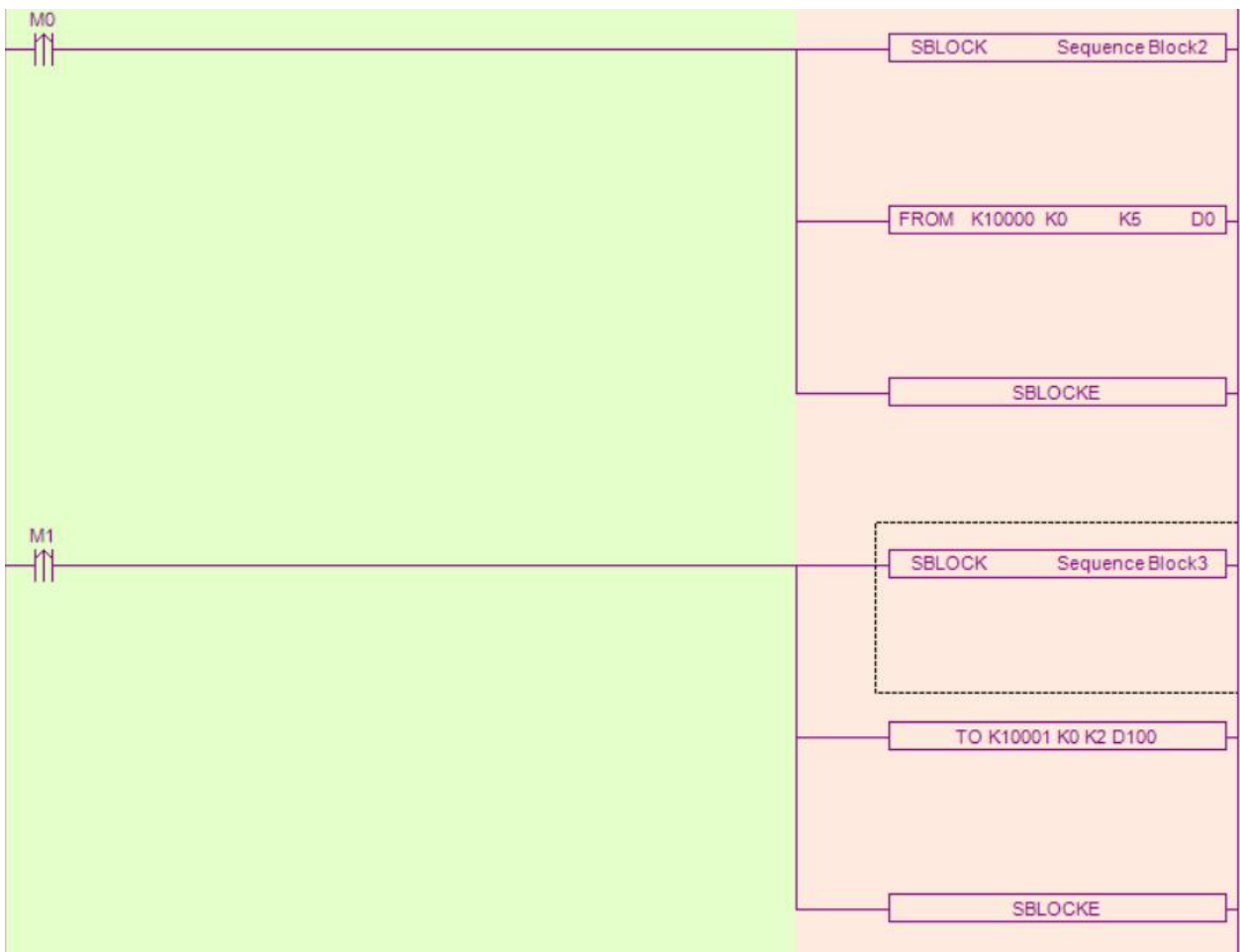

(h) Ladder chart

Write instruction TO

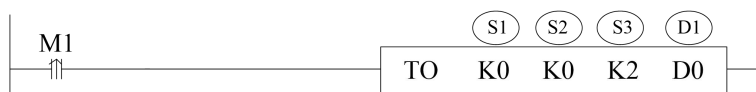

Function: write the PLC register data to module specified address, the unit is word.

Operand:

S1: target module number. Operand: K, TD, CD, D, HD, FD.

S2: module first address. Operand: K, TD, CD, D, HD, FD.

S3: write in register quantity. Operand: K, TD, CD, D, HD, FD.

D1: write in data register first address in PLC. Operand: TD, CD, D, HD, FD.

Example: write the weight value to module no.1 channel 1

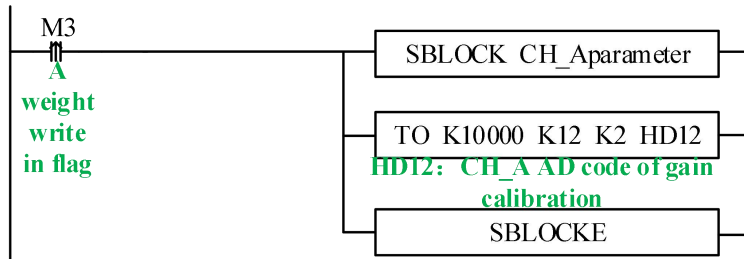

Read instruction FROM

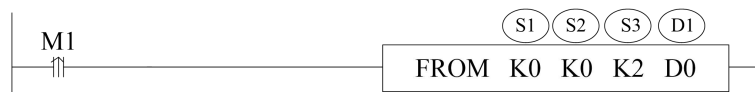

Function: read the module data to PLC register, the unit is word.

Operand:

S1: target module number. Operand: K, TD, CD, D, HD, FD.

S2: module first address. Operand: K, TD, CD, D, HD, FD.

S3: read register quantity. Operand: K, TD, CD, D, HD, FD.

D1: PLC register first address. Operand: TD, CD, D, HD, FD.

For example: read all the parameters of module no.1

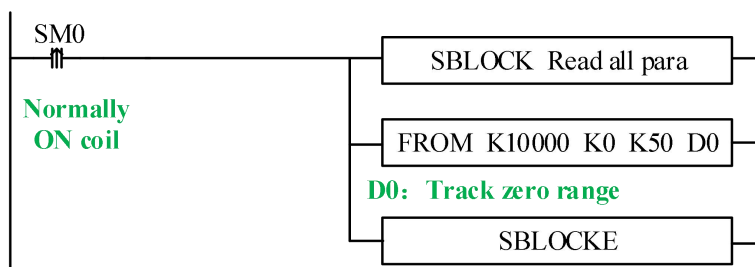

Note:

1. From/TO instruction can only be written in sequence function block, XD series PLC with firmware version less than v3.4.5 only allows up to 8 function blocks; XD/XL series PLC with firmware version v3.4.5 and above can write up to 100 blocks in the program, but can only run up to 8 blocks at the same time.
2. The starting number of module starts from k10000, k10000 is module 1 and k10001 is module 2. By analogy, module 16 is K10015.

13-11. Application program

Take module 1 as an example:

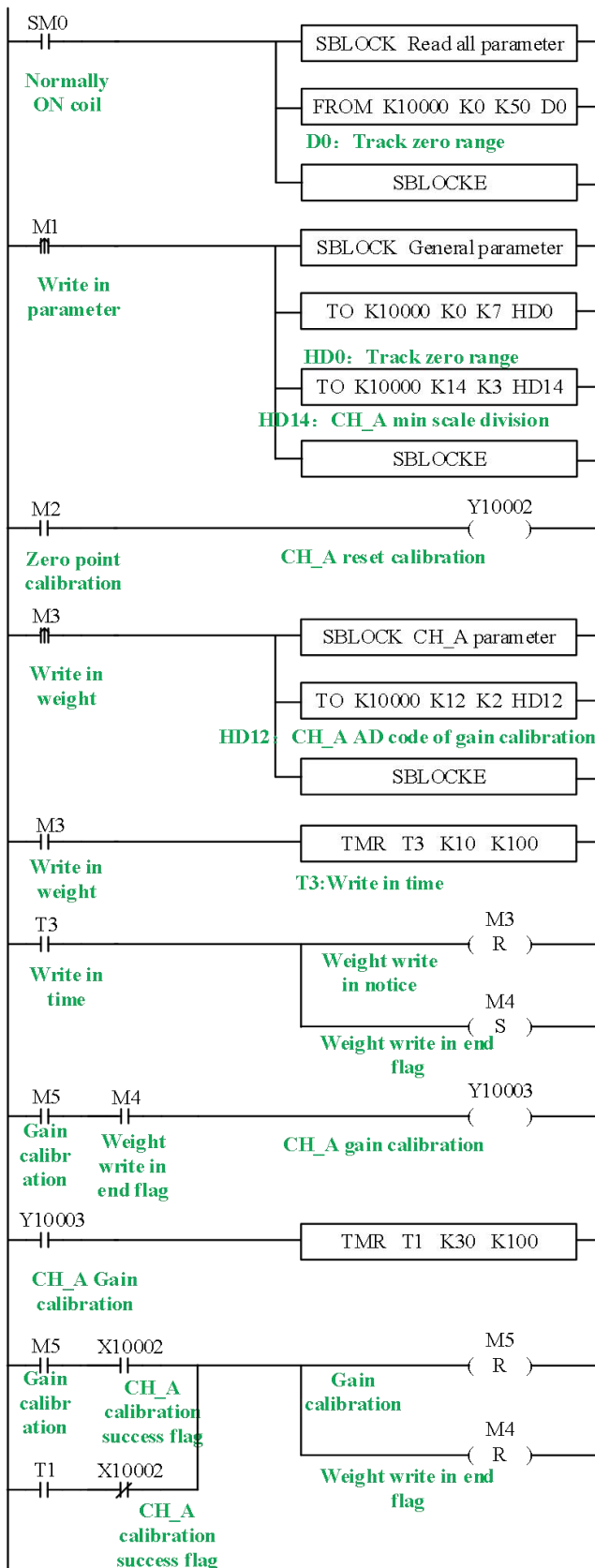

Explanation:

Read all the parameters and write in general parameters through FROM/TO instruction.

Set ON M1, write in all the parameters of channel 1.

Zero-point calibration: set ON M2, if zero-point calibration is successful, X10002 is set ON.

Gain calibration: first set ON M3, write the weight value HD12 to the module. After write in success flag M4 is ON, it starts to calibrate gain. Set ON M5 to start the calibration, the preset stable time is 3s. after the scale is stable, gain calibration success flag X10002 is ON or calibration time T1 reached, reset M4, M5, gain calibration is finished.

14. Pt100 temperature control module XD-E6PT-P

14-1. Specification

This chapter mainly introduces XD-E6PT-P module specification, terminal description, input definition number assignment, working mode setting, external connection, A/D conversion diagram and related programming examples.

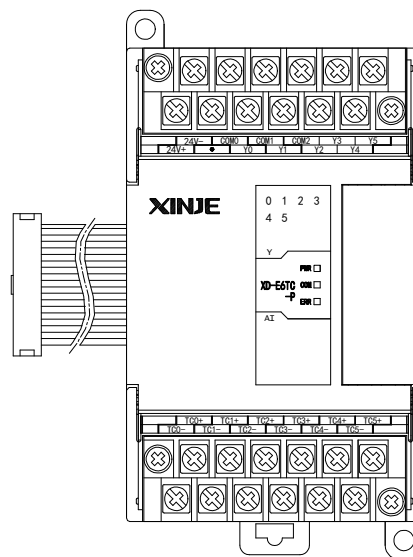

Features:

- Two wires platinum thermistor input, division numbers Pt100, Pt1000
- 6 channels input, 6 channels output, 6 groups of PID parameters, auto-tune function
- 1mA constant current output, will not be affected by the exterior environment
- Resolution is 0.1°C
- As the special function module of XD3/XD3E, 10 modules can be connected to the PLC. XD5/XDM/XDC/XD5E/XDME/XDH can extend 16 modules. XD1/XD2 cannot extend modules.

Specifications:

Item	Content
Analog input signal	Pt100, Pt1000 platinum thermal-resistance
Temperature measurement range	-100°C ~ 500°C
Digital output bound	-1000~5000
Resolution	0.1°C
Integrate precision	±0.5% (relative max value)
Conversion speed	480ms/6 channels
Analog power	DC24V±10%, 50mA
Installation format	Fixed with M3 screws or directly installed on orbit of DIN46277 (Width: 35mm)
Dimension	63mm×108mm×89.9mm

Note:

1. Without signal input, the channel data will be 5000
2. Connect to Pt100, Pt1000 platinum thermal resistance according to actual requirements
3. Only firmware version V103 and above modules support Pt1000, and can be used in conjunction with version V3.7.16 and above XDPPro software configuration.

14-2. Terminals

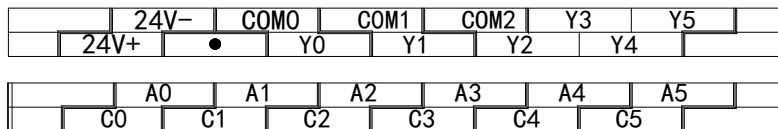

Channel	Terminal name	Signal name
CH0	A0	0CH PT100 input
	C0	0CH common terminal of PT100 input
CH1	A1	1CH PT100 input
	C1	1CH common terminal of PT100 input
CH2	A2	2CH PT100 input
	C2	2CH common terminal of PT100 input
CH3	A3	3CH PT100 input
	C3	3CH common terminal of PT100 input
CH4	A4	4CH PT100 input
	C4	4CH common terminal of PT100 input
CH5	A5	5CH PT100 input
	C5	5CH common terminal of PT100 input
-	Y0	Channel 0 output
	Y1	Channel 1 output

	Y2	Channel 2 output
	Y3	Channel 3 output
	Y4	Channel 4 output
	Y5	Channel 5 output
	COM0	Common terminal of Y0 output
	COM1	Common terminal of Y1 output
	COM2	Common terminal of Y2~Y5 output
-	24V+	+24V power supply
	24V-	Common terminal of power supply

14-3. I/O address assignment

XD series analog modules don't occupy I/O units; the converted data is directly transferred into PLC register. The PLC registers are shown as the following:

Parameters	Explanation				
	Channel	Ch0	Ch1	Ch5
Display temperature Unit: 0.1 °C	Module 1	ID10000	ID10001	ID1000×	ID10005
	Module 2	ID10100	ID10101	ID10X0×	ID10105
	ID10X00	ID10X01	ID10X0×	ID10X05
	Module 16	ID11500	ID11501	ID1150×	ID11505
PID output (return to the X input of PLC)	Module 1	X10000	X10001	X1000×	X10005
	Module 2	X10100	X10101	X1010×	X10105
	X10×00	X10×01	X10×0×	X10×05
	Module 16	X11700	X11701	X1170×	X11705
	When the "Y function selection" is set to "channel enable", Y10000-Y10005 (taking # 1 module as an example) is the PID enable bit, and the PID duty cycle output needs to be monitored from X10000 to X10005 (taking # 1 module as an example).				
Connection state of PT100 (0 is connection, 1 is disconnection)	Module 1	X10010	X10011	X1001×	X10015
	Module 2	X10110	X10111	X1011×	X10115
	X10××0	X10××1	X10×××	X10××5
	Module 16	X11710	X11711	X1171×	X11715
Enable signal (0: OFF, 1: PID is ON)	Module 1	Y10000	Y10001	Y1000×	Y10005
	Module 2	Y10100	Y10101	Y1010×	Y10105
	Y1××00	Y1××01	Y1××0×	Y1××05
	Module 16	Y11700	Y11701	Y1170×	Y11705

	<p>When the "Y function selection" is set to "immediate output", Y0~Y5 are ordinary switch output terminals, and Y10000~Y10005 (taking # 1 module as an example) can be used to directly control the Y0~Y5 outputs on the module;</p> <p>When the "Y function selection" is set to "channel enable", Y0~Y5 are the PID output terminals, and Y10000~Y10005 (taking # 1 module as an example) can be used to enable the corresponding channel's PID control. The Y0~Y5 outputs on the module are automatically calculated and controlled by the PID.</p>				
PID auto-tune error signal bit (0 is normal, 1 is error)	Module 1	X10020	X10021	X1002×	X10025
	Module 2	X10120	X10121	X1012×	X10125
	X1××20	X1××21	X1××2×	X1××25
	Module 16	X11720	X11721	X1172×	X11725

Note: when "Y function selection" is set to "immediate output", only channel display temperature value, temperature deviation value δ and calibration environment temperature value are valid in the above parameters, and other parameters do not work.

14-4. Working mode

There are two ways to set the working mode:

1. XDPpro software
2. Flash registers of PLC

XDPpro software:

Open the XDPpro software, click configure/expansion module settings:

Set the model and channel parameters in the following window. Then click write to PLC.

Please restart the PLC after setting.

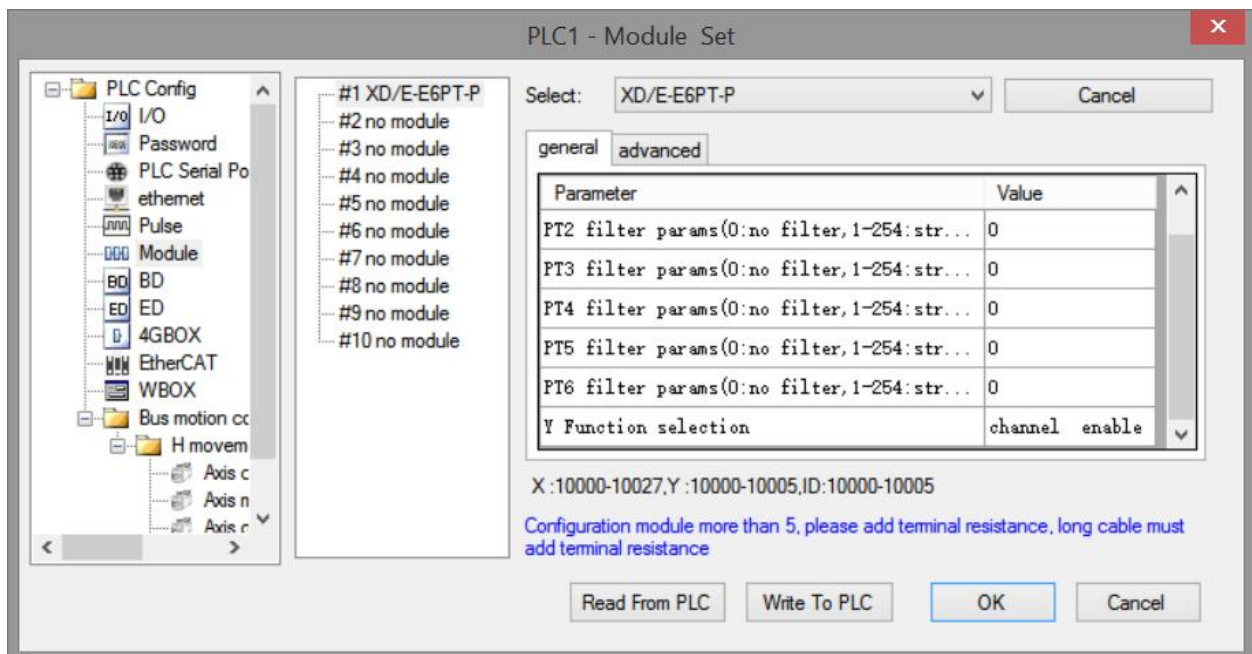

Note:

1. the first-order low-pass filtering method uses this sampling value and the last filtering output value for weighting to obtain the effective filtering value.

2: the filter coefficient is set to 0 ~ 254 by the user, the smaller the value is, the more stable the data is, but it may cause data lag; when it is set to 1, the filtering effect is the strongest, and when it is set to 254, the filtering effect is the weakest, and the default value is 0 (no filtering).

3: "Y function selection" is only supported by modules with firmware version V100 and above.

4: "Y function selection" is used to specify the functions of Y10000 ~ Y10005 (take # 1 module as an example). The factory default is "channel enable", which supports the PID control function of the module itself. When it is set to "immediate output", the output points Y0 ~ Y5 on the module are ordinary digital output points, while the module only retains the temperature acquisition function. If you need temperature control, please use the PID command of PLC body.

Flash registers:

Set the filtering parameter through Flash registers of PLC.

Module no.	SFD address	Module no.	SFD address
#1	SFD350~SFD359	#9	SFD430~SFD439
#2	SFD360~SFD369	#10	SFD440~SFD449
#3	SFD370~SFD379	#11	SFD450~SFD459
#4	SFD380~SFD389	#12	SFD460~SFD469
#5	SFD390~SFD399	#13	SFD470~SFD479
#6	SFD400~SFD409	#14	SFD480~SFD489
#7	SFD410~SFD419	#15	SFD490~SFD499
#8	SFD420~SFD429	#16	SFD500~SFD509

Take module 1 as an example:

Register	Bit7	Bit6	Bit5	Bit4	Bit3	Bit2	Bit1	Bit0
SFD350	Byte0	PT channel 1 filter parameter						
	Byte1	PT channel 2 filter parameter						
SFD351	Byte2	PT channel 3 filter parameter						
	Byte3	PT channel 4 filter parameter						
SFD352	Byte4	PT channel 5 filter parameter						

	Byte5	PT channel 6 filter parameter	
SFD353	Byte6	-	
	Byte7	-	
SFD354	Byte8	-	-
	Byte9	-	-
SFD355	Byte10	PT2 sensor type	PT1 sensor type
	Byte11	PT4 sensor type	PT3 sensor type
SFD356	Byte12	PT6 sensor type	PT5 sensor type
	Byte13	-	-
SFD357~SFD359		-	

14-5. FROM/TO instruction

The reading and writing of XD-E6PT-P module needs to be completed through the FROM/TO instruction in the sequential function block, as shown in the figure below:

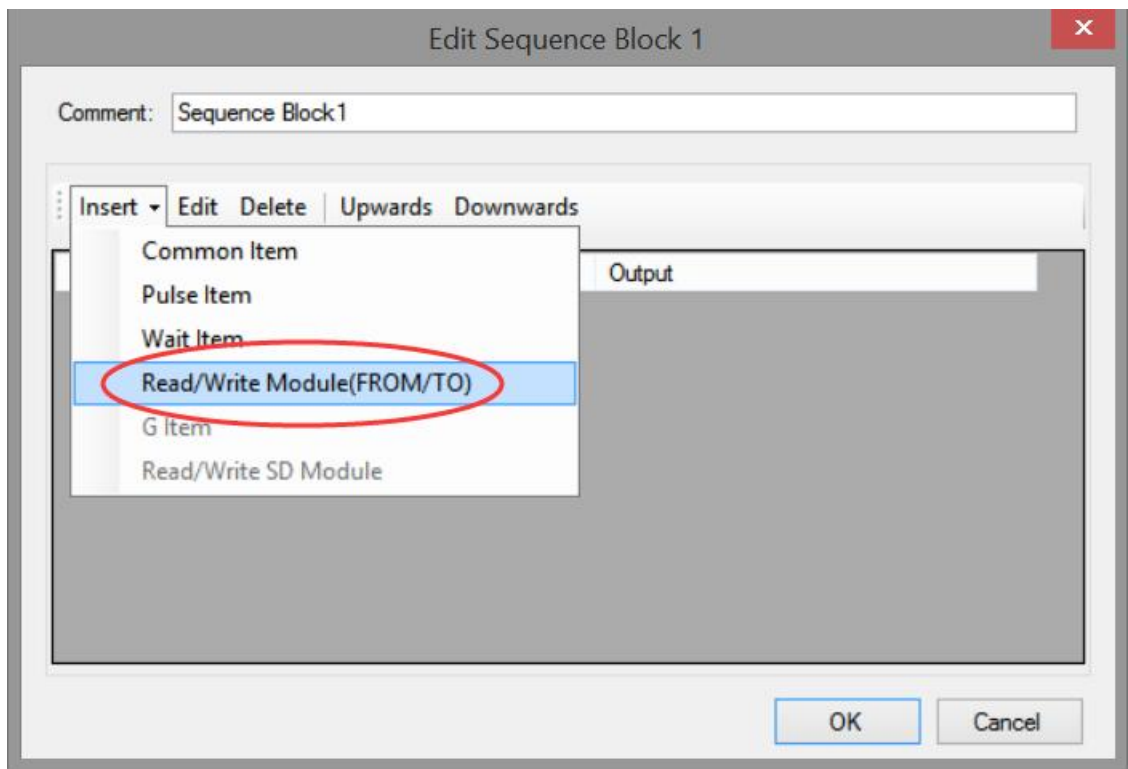

(a) Insert FROM/TO module

Read/Write Module

Skip Comment:

Read module Write module Type: ▾

Module no: ▾ Module address:

Count: PLC address:

(b) Write instruction

Read/Write Module

Skip Comment:

Read module Write module Type: ▾

Module no: ▾ Module address:

Count: PLC address:

(c) Read instruction

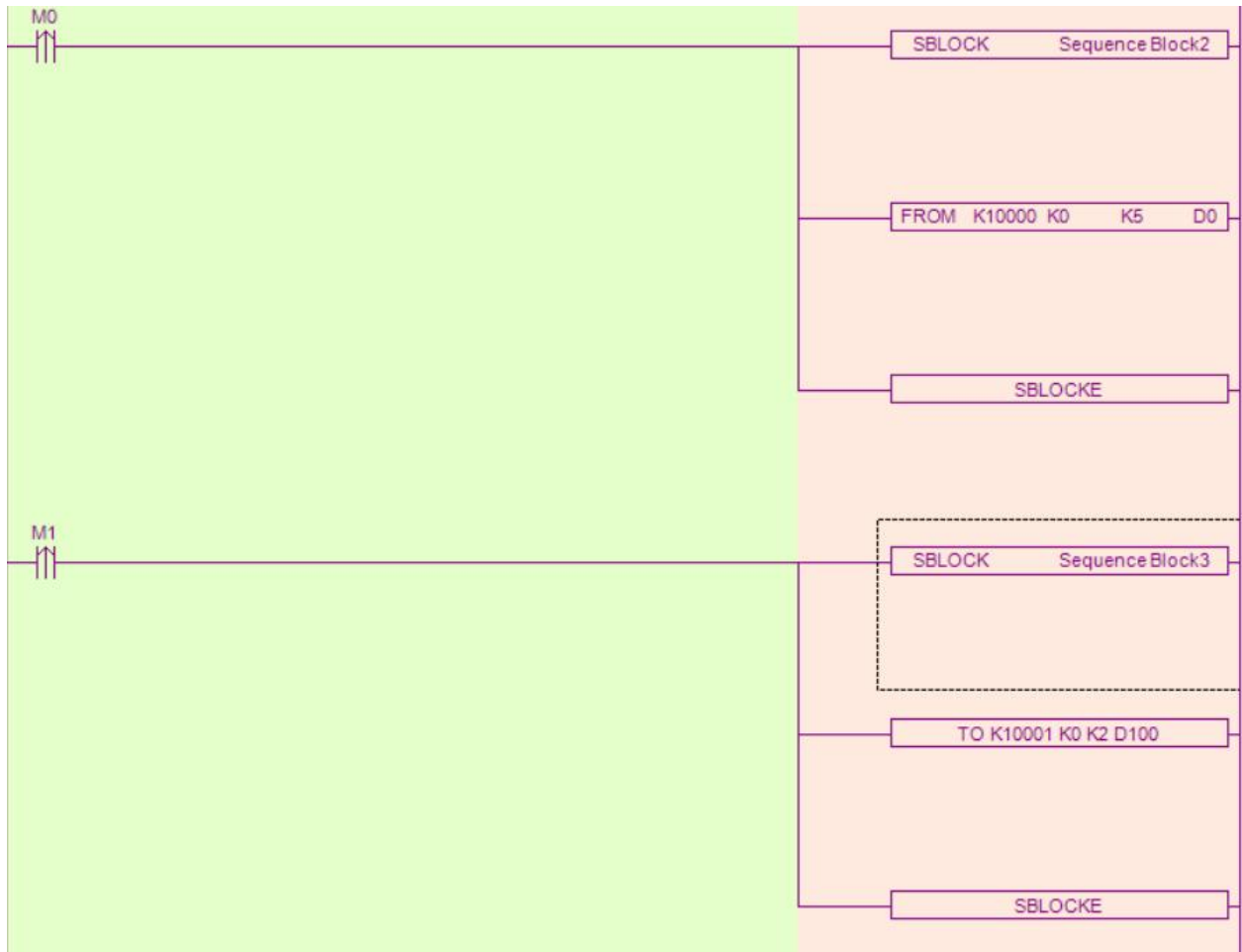

(d) Ladder chart

FROM and TO instructions

(1) Parameter write instruction TO



Function: write the PLC register data to module address, the operate unit is word.

Operand:

S1: target module number, range: 10000~10015. Operand: K, TD, CD, D, HD, FD

S2: first address of module. Operand: K, TD, CD, D, HD, FD

S3: write in register numbers. Operand: K, TD, CD, D, HD, FD

D1: first address of PLC. Operand: TD, CD, D, HD, FD

(2) Parameter read instruction FROM



Function: read the module data to the PLC register, the operate unit is word.

S1: target module number, range: 10000~10015. Operand: K, TD, CD, D, HD, FD

S2: first address of module. Operand: K, TD, CD, D, HD, FD

S3: read register numbers. Operand: K, TD, CD, D, HD, FD

D1: first address of PLC. Operand: TD, CD, D, HD, FD

Note:

1: FROM/TO instruction can only be written in sequence function block, XD series PLC with firmware version less than v3.4.5 only allows up to 8 block function blocks; XD / XL series PLC with firmware version v3.4.5 and above can write up to 100 blocks in the program, but can only run up to 8 blocks at the same time.

2: The starting number of module starts from K10000, K10000 for # 1 module and k10001 for # 2 module. By analogy, # 16 module is K10015.

3: In v3.3 and below version software, the module number range is K0~K15. Please pay attention to the modification when transferring projects in different versions of software.

Related address definition:

The address of the read/write parameters:

From_To data	Default value	CH1	CH2	CH3	CH4	CH5	CH6	R/W	
Auto-tune enable	0	K0	K0	K0	K0	K0	K0	RW	
PID output	-	K1	K2	K3	K4	K5	K6	R	
Setting	0	K7	K8	K9	K10	K11	K12	RW	
PID	Kp	40	K13	K17	K21	K25	K29	K33	RW
	Ki	240	K14	K18	K22	K26	K30	K34	RW
	Kd	60	K15	K19	K23	K27	K31	K35	RW
	Diff	1000	K16	K20	K24	K28	K32	K36	RW
Temperature control period (unit: 0.1s)	20	K37	K38	K39	K40	K41	K42	RW	
Output range (0~100)	100	K43	K44	K45	K46	K47	K48	RW	
Temperature deviation calibration	0	K49	K50	K51	K52	K53	K54	RW	
Present actual temperature, can be used to calibrate	-	K55	K56	K57	K58	K59	K60	W	
FROM/TO data initialization	-	K61	K61	K61	K61	K61	K61	W	

PID control bit	Auto-tune triggered signal, start to auto-tune mode when set to 1 After auto-tune, PID parameters and temperature control period value are refreshed, the bit value is cleared to be 0. The user can read the bit to know the state. 1 means auto-tune is ongoing. 0 means auto-tune has finished.
PID output (0~4095)	When the PID output is for analog control (such as steam valve opening or thyristor conduction angle), this value can be transmitted to the analog output module to achieve control requirements.
PID parameters (P, I, D)	The best PID parameters got from the PID auto-tune. If the current PID parameters cannot meet the control requirements, users can set

	the experience PID parameters to make the module work according to the user setting value.
PID calculation range (Diff) Unit: 0.1°C	PID arithmetic is effective in the range of T (setting temperature) ±Diff. In real temperature control environment, when the temperature is lower than T- Diff, the PID output is the maximum value; when the temperature is higher than T+Diff, the PID output is 0.
Temperature difference value δ Unit: 0.1°C	(sampling temperature value + temperature difference value δ) / 10 = display temperature. At the time the display temperature is the closest to the real temperature. This parameter is a sign value with the unit of 0.1°C, the value is retained when th power is cut off, the defaulted value is 0.
Set temperature Unit: 0.1°C	The target temperature of the control system. Range from -1000~5000, which is -100.0~500.0°C.
Temperature control period Unit: 0.1s	The temperature control period ranges from 0.5 to 200 seconds, the minimum precision is 0.1 second. The set value = real value × 10. For example: if the real temperature control period is 0.5 seconds, user should set 5 seconds in the module.
Calibration Environment temperature Unit: 0.1°C	If user realizes that the environment temperature is different from display temperature, they can write the correct environment temperature into the module. Then the module will calculate the temperature difference δ and save it. Temperature difference δ = adjusting environment temperature — sampling temperature. Unit: 0.1°C. For example, under the caloric balance condition, users measured the environment temperature is 60°C with mercury thermometer, but the display temperature is 55°C (sampling temperature is 550), temperature difference δ is 0. At this time, users can set the parameter to be 600, then the temperature difference δ is 50 (5 °C). Display temperature = (550 + 50) / 10 = 60 °C. **Attention: when setting the adjusting environment temperature, make sure it is the same as environment temperature. It is very important because the incorrect parameter will result in mistake of calculating temperature difference δ and affect the display temperature.
auto-tune output range	The auto-tune output unit is percent. 100 means the duty ratio is 100% of the full-scale output, 80 means the duty ratio is 80% of the full-scale output.
From/To Data initialization	This function can restore the parameters in the above table to their factory settings. When using it, K61 needs to be set to 1, set to other values are invalid.

Note:

- (1) the "from / to data initialization" function requires the firmware version of the module to be V100 or above. This function can restore the parameters in the above table to the factory settings. When using it, you need to set K61 to 1, and set to other values are invalid.
- (2) When the "Y function selection" is set to "immediate output", only the "temperature deviation value δ ", "the calibration of the ambient temperature value" is valid, and other parameters are not effective.
- (3) The module can automatically save the set temperature value, PID parameters, temperature control cycle, output range, temperature deviation and temperature calibration parameters. When writing the above parameters, the rising edge should be used to trigger the writing. It is recommended to write only the

parameters used. It is not recommended to write the whole piece of data for the convenience of programming, because writing 0 to some addresses will cause the system to fail to work.

- (4) The self-tuning enable address K0: K0 will occupy a continuous 8-bit address space. The enable bits of the 6-channel module correspond to the first 6 bits address space, and the last 2 bits addresses are idle (but cannot be used for other purposes). When the read/write enable bit is enabled, K0 can be a coil or register. When it is a coil, it occupies 8 consecutive bits starting from the coil address; When it is a register, it occupies that register. For example, to set the first and third channels of the module to self-tuning mode, and the remaining four channels to manual PID mode, with the command To K10000 K0 K1 M10, M10 and M12 should be set to ON, and M11, M13, M14, and M15 should be set to OFF; When the instruction is To K10000 K0 K1 D100, D100 should be assigned a value of 5.

14-6. Exterior connection

About the external wiring, please see the following items:

- When connect +24V power, please use 24V power on PLC main unit to avoid interference.
- To avoid interference, please use shield cable to ground.

Input connection:

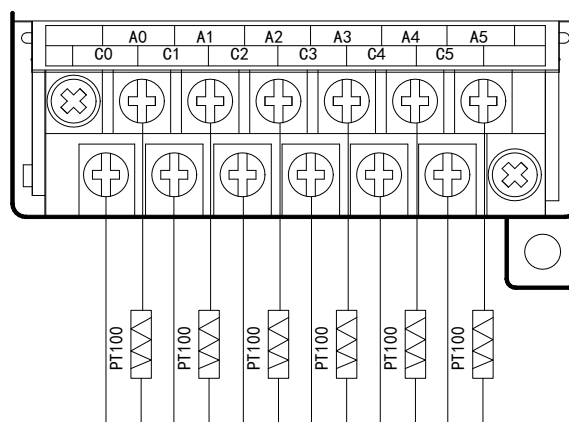

Note: For a three wires platinum thermistor, please connect two wires of the same color to the C0 end and the other wire to the A0 or A1 end.

Output connection:

- ◆ Output terminals: transistor output terminal please choose DC 5V~30V power supply.
- ◆ Circuit insulation
PLC interior circuit and output transistor is optical insulation. Each public module is also separated.
- ◆ Response time
The time is less than 0.2ms from PLC driving (or cut) optical coupling device to transistor ON/OFF.
- ◆ Output current
Each point current is 50mA to avoid over-heat.
- ◆ Open circuit leakage current

Below 0.1mA

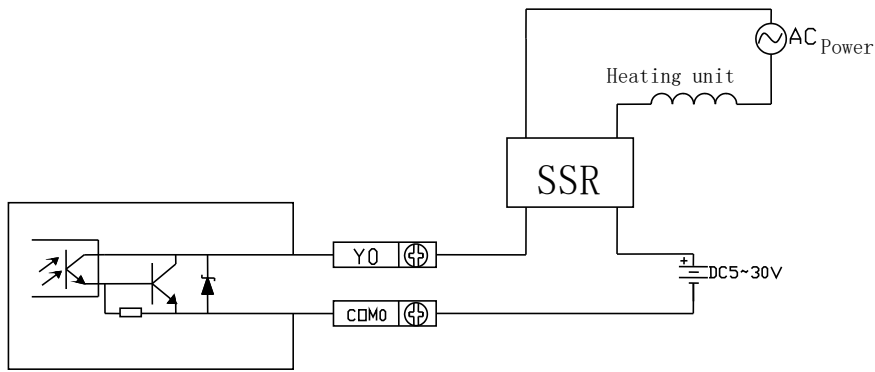

PT100 input features:

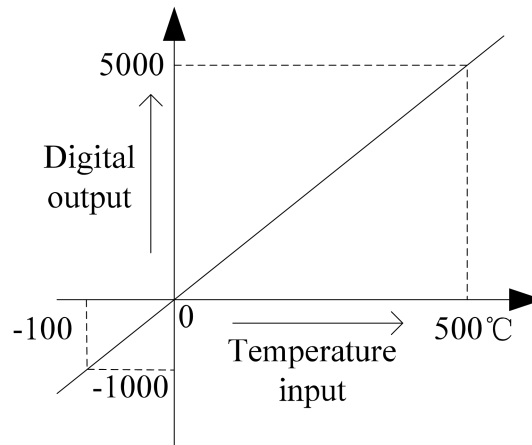

14-7. Programming

When temperature control is required, there are two programming options:

1, use the PID of the PLC body for temperature control, at this time, you need to switch the Y function selection to 'immediate output', the programming case details please refer to "XDXL PLC instruction manual" chapter 7 PID control functions.

2, use the built-in PID of the module for temperature control, at this time, you need to switch the Y function selection to "channel enable", programming cases such as shown in following example 1.

Example 1: Module 1, PID control for CH0

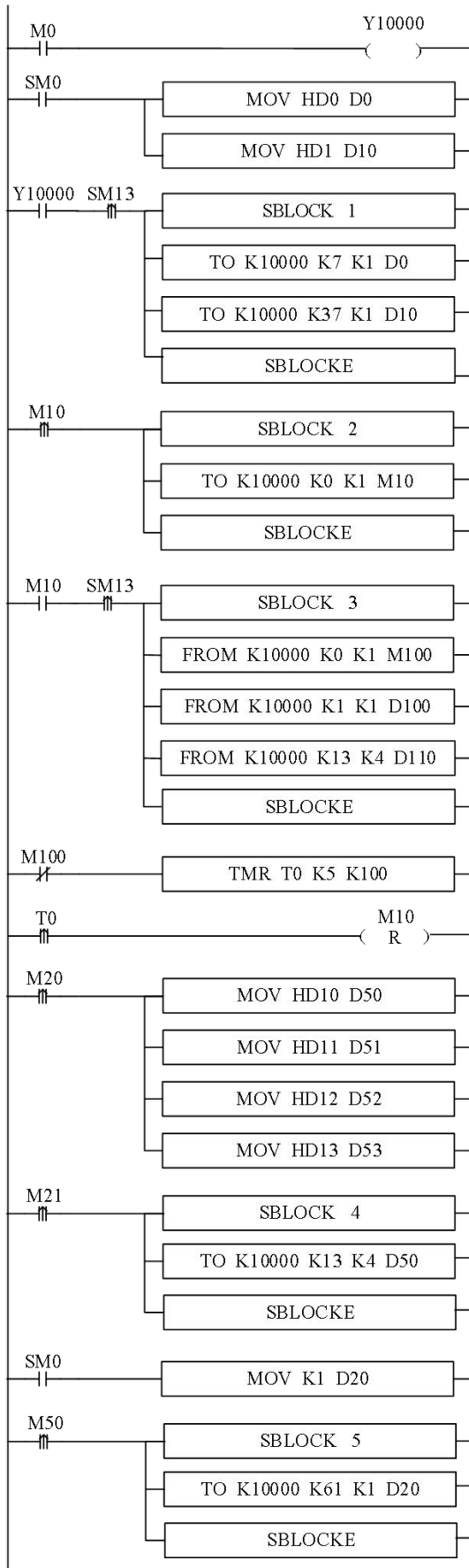

// set ON the PID enable bit

// set the target value (unit: 0.1°C)

// set temperature control cycle (unit: 0.1s)

//write in the target value, temperature control period

// write in auto-tune bit

// read auto-tune bit and PID parameters

// read auto-tune bit

// read PID output value

// read P, I, D, DIFF parameters

//after auto-tune bit reset for 0.5s, reset auto-tune flag bit

//set P value

//set I value

//set D value

//set Diff value

//manually PID control, write in PID parameters

//initialize the module parameters

Explanation:

(1) When the auto-tuning enable is turned on, the command will immediately occupy 8 bits of M10-M17 in total. M10-M15 corresponds to the auto-tuning enable of each channel. M16 and M17 have no meaning and need to be left blank.

(2) If the output is a solid state relay, the temperature control cycle is recommended to be 1 ~ 3s; if the output is a relay, the temperature control cycle is recommended to be 3 ~ 15s.

(3) Due to the inconsistency of units, the parameters of PLC main body PID and module PID cannot be used in common. The PID parameters of the PLC are in upper case and the PID parameters of the module are in lower case. The specific conversion relations are as follows: $p = P/100$; $i = I/10$; $d = D/100$.

Soft component functions:

M0	Set ON the PID enable
SM0	Set the target value, temperature control bit
M10	Write in auto-tune bit
M20	Set manually PID parameters
M21	Write-in manually PID parameters
M10	Read auto-tune bit, PID parameters, PID output
M50	Initialize the module
Y10000	PID enable bit of channel 0
D0	Set the target value
D10	Temperature control period
D50	P
D51	I
D52	D
D53	DIFF

15. Pt100 temperature control module XD-E4PT3-P

15-1. Specification

This chapter mainly introduces XD-E4PT3-P module specification, terminal description, input definition number assignment, working mode setting, external connection, A/D conversion diagram and related programming examples.

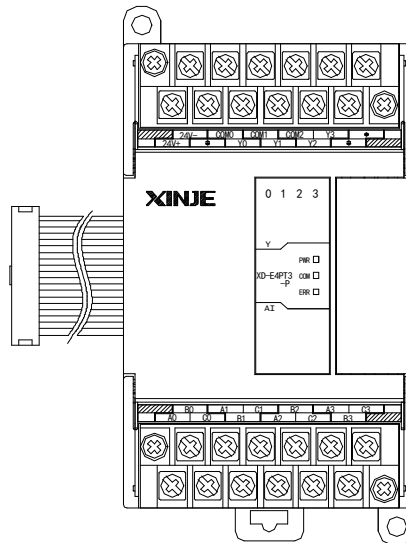

Features:

- Three wires platinum thermistor input, division numbers Pt100, Pt1000
- 4 channels input, 4 channels output, 4 groups of PID parameters, auto-tune function
- 1mA constant current output, will not be affected by the exterior environment
- Resolution is 0.1°C
- As the special function module of XD3/XD3E, 10 modules can be connected to the PLC. XD5/XDM/XDC/XD5E/XDME/XDH can extend 16 modules. XD1/XD2 cannot extend modules.

Specifications:

Item	Content
Analog input signal	Pt100, Pt1000 platinum thermal-resistance
Temperature measurement range	-100°C ~ 500°C
Digital output bound	-1000~5000
Resolution	0.1°C
Integrate precision	±0.5% (relative max value)
Conversion speed	450ms every 4 channels
Analog power	DC24V±10%, 50mA

Installation format	Fixed with M3 screws or directly installed on orbit of DIN46277 (Width: 35mm)
Dimension	63mm×108mm×89.9mm

Note:

1. Without signal input, the channel data will be 5000
2. Connect to Pt100, Pt1000 platinum thermal resistance according to actual requirements
3. Only firmware version V103 and above modules support Pt1000, and can be used in conjunction with version V3.7.16 and above XDPPro software configuration.

15-2. Terminals

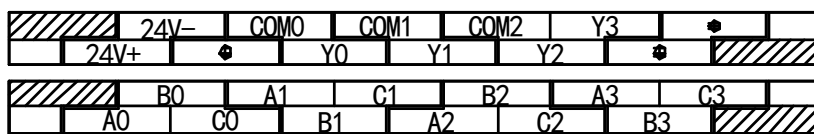

CH	Terminal	Function
-	24V+	+24V power supply input
	24V-	Common terminal of power supply
CH0	A0	CH0 temperature input
	B0	CH0 input common terminal
	C0	CH0 input common terminal
CH1	A1	CH1 temperature input
	B1	CH1 input common terminal
	C1	CH1 input common terminal
CH2	A2	CH2 temperature input
	B2	CH2 input common terminal
	C2	CH2 input common terminal
CH3	A3	CH3 temperature input
	B3	CH3 input common terminal
	C3	CH3 input common terminal
-	Y0~Y3	Digital output terminal of CH0~CH3
-	COM0~COM2	Output common terminal (Y0 corresponds to COM0, Y1 corresponds to COM1, Y2~Y3 correspond to COM2)

15-3. I/O address assignment

XD series analog modules don't occupy I/O units; the converted data is directly transferred into PLC register. The PLC registers are shown as the following:

Parameters	Explanation				
	Channel	CH0	CH1	CH2	CH3
Display temperature Unit: 0.1 °C	Module 1	ID10000	ID10001	ID10002	ID10003
	Module 2	ID10100	ID10101	ID10102	ID10103
	ID10x00	ID10x01	ID10x02	ID10x03
	Module 16	ID11500	ID11501	ID11502	ID11503
PID output (return to the X input of PLC)	Module 1	X10000	X10001	X10002	X10003
	Module 2	X10100	X10101	X10102	X10103
	X10x00	X10x01	X10x02	X10x03
	Module 16	X11700	X11701	X11702	X11703
	When the "Y function selection" is set to "channel enable", Y10000-Y10003 (taking # 1 module as an example) is the PID enable bit, and the PID duty cycle output needs to be monitored from X10000 to X10003 (taking # 1 module as an example).				
Connection state of PT100 (0 is connection, 1 is disconnection)	Module 1	X10010	X10011	X10012	X10013
	Module 2	X10110	X10111	X10112	X10113
	X10x10	X10x11	X10x12	X10x13
	Module 16	X11710	X11711	X11712	X11713
Enable signal (0: OFF, 1: PID is ON)	Module 1	Y10000	Y10001	Y10002	Y10003
	Module 2	Y10100	Y10101	Y10102	Y10103
	Y10x00	Y10x01	Y10x02	Y10x03
	Module 16	Y11700	Y11701	Y11702	Y11703
	When the "Y function selection" is set to "immediate output", Y0~Y3 are ordinary switch output terminals, and Y10000~Y10003 (taking # 1 module as an example) can be used to directly control the Y0~Y3 output of the module; When the "Y function selection" is set to "channel enable", Y0~Y3 are the PID output terminals, and Y10000~Y10003 (taking # 1 module as an example) can be used to enable the corresponding channel's PID control. The Y0~Y3 output of the module is automatically calculated and controlled by the PID.				
PID auto-tune error signal bit (0 is normal, 1 is error)	Module 1	X10020	X10021	X10022	X10023
	Module 2	X10120	X10121	X10122	X10123
	X10x20	X10x21	X10x22	X10x23
	Module 16	X11720	X11721	X11722	X11723

15-4. Working mode

There are two ways to set the working mode:

1. XDPpro software
2. Flash registers of PLC

XDPpro software:

Open the XDPpro software, click configure/expansion module settings:

Set the model and channel parameters in the following window. Then click write to PLC.
Please restart the PLC after setting.

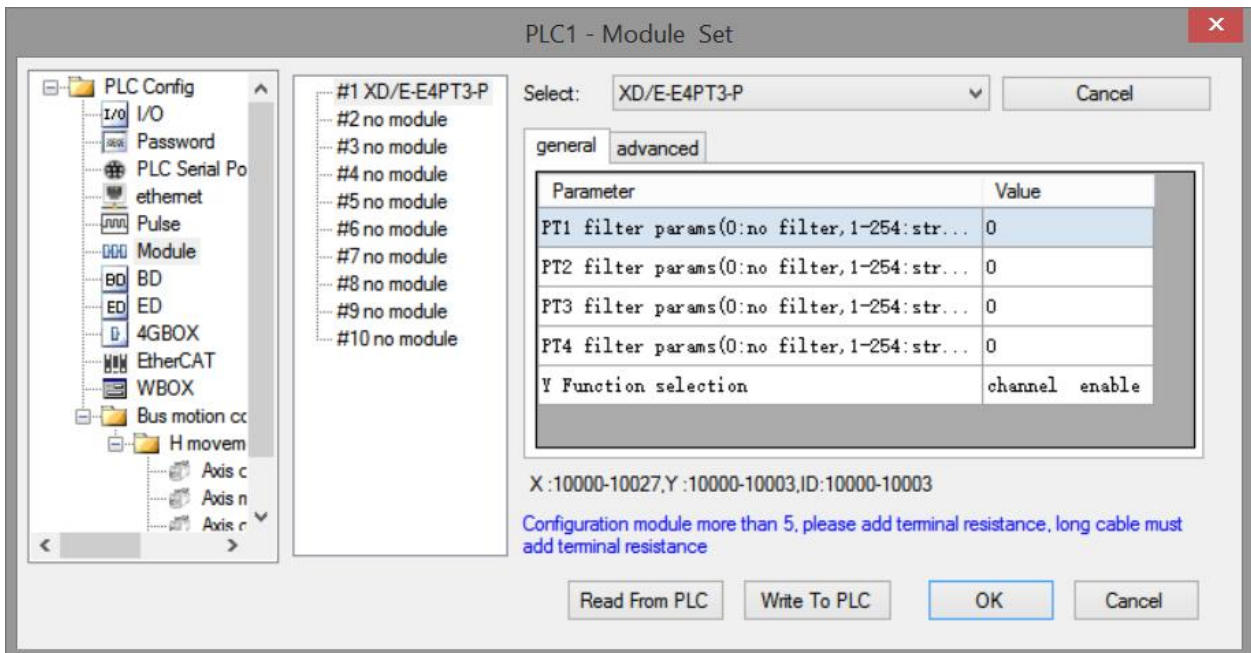

Note:

1. the first-order low-pass filtering method uses this sampling value and the last filtering output value for weighting to obtain the effective filtering value.
- 2: the filter coefficient is set to 0 ~ 254 by the user, the smaller the value is, the more stable the data is, but it may cause data lag; when it is set to 1, the filtering effect is the strongest, and when it is set to 254, the filtering effect is the weakest, and the default value is 0 (no filtering).
- 3: "Y function selection" is only supported by modules with firmware version V100 and above.
- 4: "Y function selection" is used to specify the functions of Y10000 ~ Y10003 (take # 1 module as an example). The factory default is "channel enable", which supports the PID control function of the module itself. When it is set to "immediate output", the output points Y0 ~ Y3 on the module are ordinary digital output points, while the module only retains the temperature acquisition function. If you need temperature control, please use the PID command of PLC body.

Flash registers:

Set the filtering parameter through Flash registers of PLC.

Module no.	SFD address	Module no.	SFD address
#1	SFD350~SFD359	#9	SFD430~SFD439
#2	SFD360~SFD369	#10	SFD440~SFD449
#3	SFD370~SFD379	#11	SFD450~SFD459

#4	SFD380~SFD389	#12	SFD460~SFD469
#5	SFD390~SFD399	#13	SFD470~SFD479
#6	SFD400~SFD409	#14	SFD480~SFD489
#7	SFD410~SFD419	#15	SFD490~SFD499
#8	SFD420~SFD429	#16	SFD500~SFD509

Take module 1 as an example:

Register		Bit7	Bit6	Bit5	Bit4	Bit3	Bit2	Bit1	Bit0	
SFD350	Byte0	PT channel 1 filter parameter								
	Byte1	PT channel 2 filter parameter								
SFD351	Byte2	PT channel 3 filter parameter								
	Byte3	PT channel 4 filter parameter								
SFD352	Byte4	-								
	Byte5	-								
SFD354	Byte8	-			-		Y function selection 0000: channel enable 0001: immediate output			
	Byte9	-			-					
SFD355	Byte10	PT2 sensor type			PT1 sensor type					
	Byte11	PT4 sensor type			PT3 sensor type					
SFD356	Byte12	-			-					
	Byte13	-			-					
SFD357~SFD359		Reserved								

15-5. FROM/TO instruction

The reading and writing of XD-E4PT3-P module needs to be completed through the FROM/TO instruction in the sequential function block, as shown in the figure below:

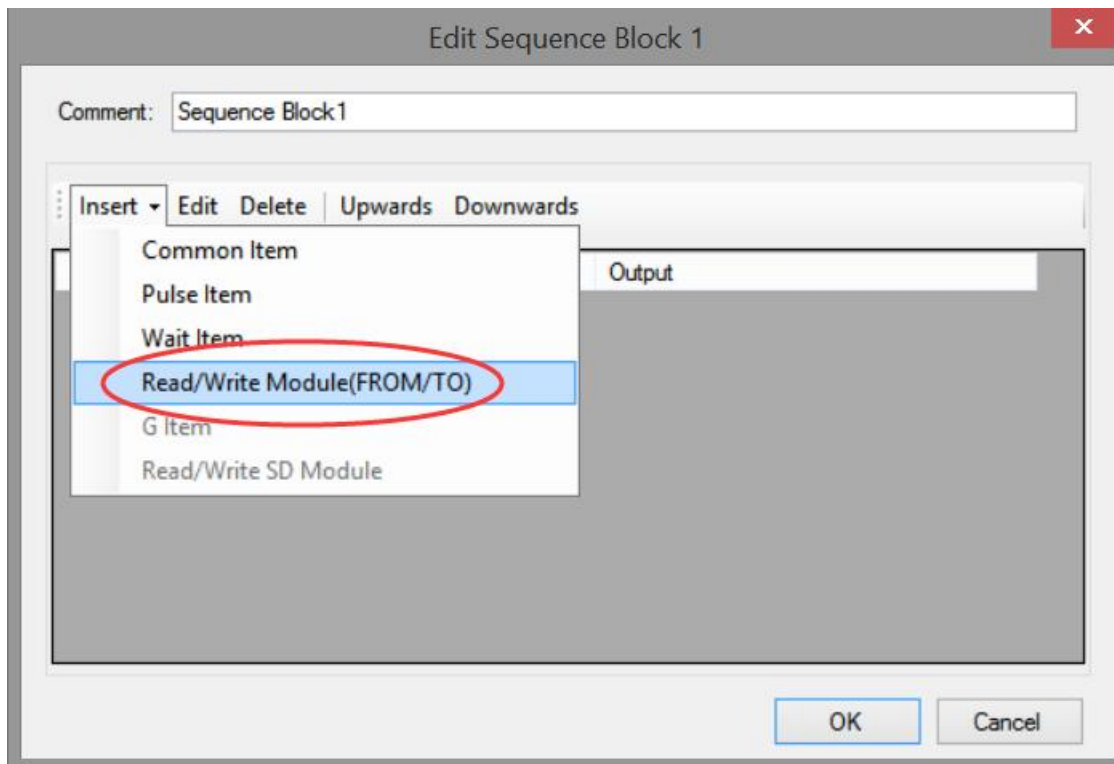

3. Insert FROM/TO module

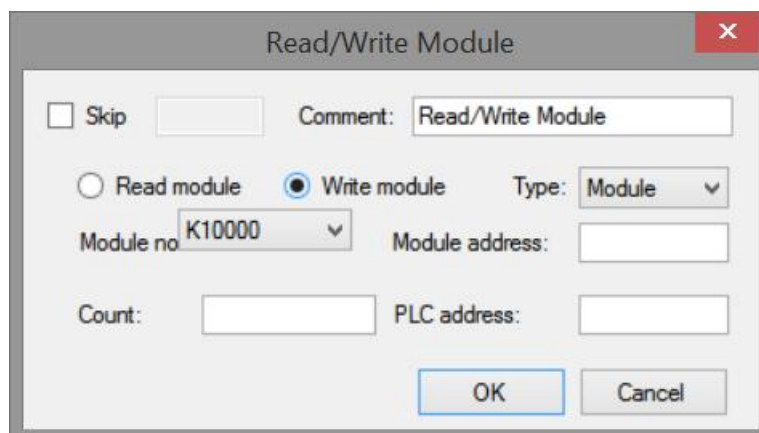

4. Write instruction

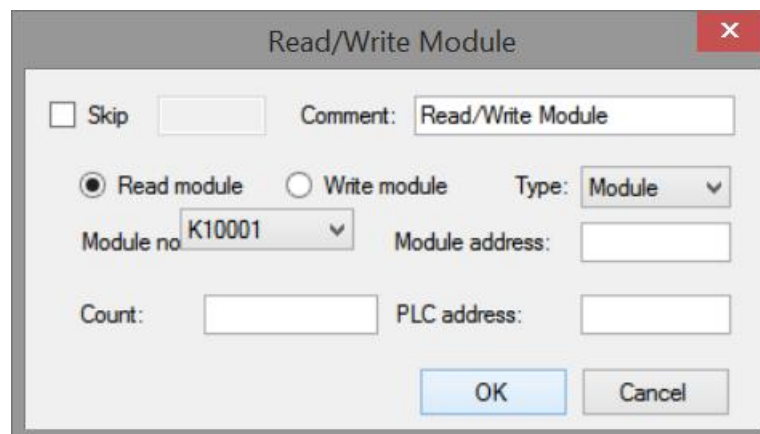

5. Read instruction

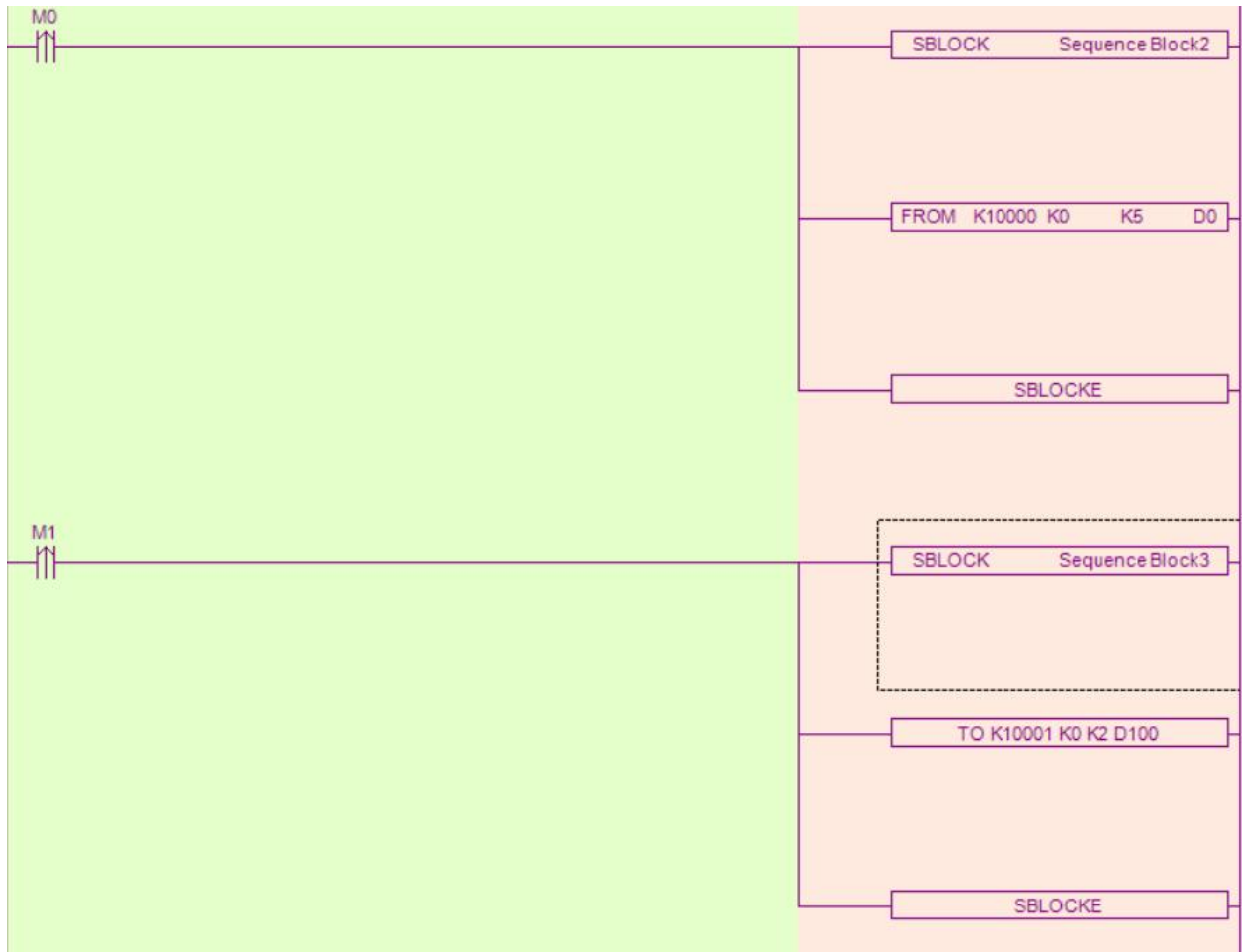

6. Ladder chart

FROM and TO instructions

(3) Parameter write instruction TO



Function: write the PLC register data to module address, the operate unit is word.

Operand:

S1: target module number, range: 10000~10015. Operand: K, TD, CD, D, HD, FD

S2: first address of module. Operand: K, TD, CD, D, HD, FD

S3: write in register numbers. Operand: K, TD, CD, D, HD, FD

D1: first address of PLC. Operand: TD, CD, D, HD, FD

(4) Parameter read instruction FROM



Function: read the module data to the PLC register, the operate unit is word.

S1: target module number, range: 10000~10015. Operand: K, TD, CD, D, HD, FD

S2: first address of module. Operand: K, TD, CD, D, HD, FD

S3: read register numbers. Operand: K, TD, CD, D, HD, FD

D1: first address of PLC. Operand: TD, CD, D, HD, FD

Note:

1: FROM/TO instruction can only be written in sequence function block, XD series PLC with firmware version less than v3.4.5 only allows up to 8 block function blocks; XD / XL series PLC with firmware version v3.4.5 and above can write up to 100 blocks in the program, but can only run up to 8 blocks at the same time.

2: The starting number of module starts from K10000, K10000 for # 1 module and k10001 for # 2 module. By analogy, # 16 module is K10015.

3: In v3.3 and below version software, the module number range is K0~K15. Please pay attention to the modification when transferring projects in different versions of software.

Related address definition:

The address of the read/write parameters:

From_To data	Default value	CH1	CH2	CH3	CH4	R/W	
Auto-tune enable	0	K0	K0	K0	K0	RW	
PID output	-	K1	K2	K3	K4	R	
Setting	0	K5	K6	K7	K8	RW	
PID	Kp	K9	K13	K17	K21	K25	RW
	Ki	K10	K14	K18	K22	K26	RW
	Kd	K11	K15	K19	K23	K27	RW
	Diff	K12	K16	K20	K24	K28	RW
Temperature control period (unit: 0.1s)	20	K25	K26	K27	K28	RW	
Output range (0~100)	100	K29	K30	K31	K32	RW	
Temperature deviation calibration	0	K33	K34	K35	K36	RW	
Present actual temperature, can be used to calibrate	-	K37	K38	K39	K40	W	
FROM/TO data initialization	-	K41	K41	K41	K41	W	

PID control bit	Auto-tune triggered signal, start to auto-tune mode when set to 1 After auto-tune, PID parameters and temperature control period value are refreshed, the bit value is cleared to be 0. The user can read the bit to know the state. 1 means auto-tune is ongoing. 0 means auto-tune has finished.
PID output (0~4095)	When the PID output is for analog control (such as steam valve opening or thyristor conduction angle), this value can be transmitted to the analog output module to achieve control requirements.
PID parameters (P, I, D)	The best PID parameters got from the PID auto-tune. If the current PID parameters cannot meet the control requirements, users can set

	the experience PID parameters to make the module work according to the user setting value.
PID calculation range (Diff) Unit: 0.1°C	PID arithmetic is effective in the range of T (setting temperature) \pm Diff. In real temperature control environment, when the temperature is lower than T- Diff, the PID output is the maximum value; when the temperature is higher than T+Diff, the PID output is 0.
Temperature difference value δ Unit: 0.1°C	(sampling temperature value + temperature difference value δ) / 10 = display temperature. At the time the display temperature is the closest to the real temperature. This parameter is a sign value with the unit of 0.1°C, the value is retained when th power is cut off, the defaulted value is 0.
Set temperature Unit: 0.1°C	The target temperature of the control system. Range from -1000~5000, which is -100.0~500.0°C.
Temperature control period Unit: 0.1s	The temperature control period ranges from 0.5 to 200 seconds, the minimum precision is 0.1 second. The set value = real value \times 10. For example: if the real temperature control period is 0.5 seconds, user should set 5 seconds in the module.
Calibration Environment temperature Unit: 0.1°C	If user realizes that the environment temperature is different from display temperature, they can write the correct environment temperature into the module. Then the module will calculate the temperature difference δ and save it. Temperature difference δ = adjusting environment temperature $-$ sampling temperature. Unit: 0.1°C. For example, under the caloric balance condition, users measured the environment temperature is 60°C with mercury thermometer, but the display temperature is 55°C (sampling temperature is 550), temperature difference δ is 0. At this time, users can set the parameter to be 600, then the temperature difference δ is 50 (5 °C). Display temperature = (550 + 50) / 10 = 60 °C. **Attention: when setting the adjusting environment temperature, make sure it is the same as environment temperature. It is very important because the incorrect parameter will result in mistake of calculating temperature difference δ and affect the display temperature.
auto-tune output range	The auto-tune output unit is percent. 100 means the duty ratio is 100% of the full-scale output, 80 means the duty ratio is 80% of the full-scale output.
From/To Data initialization	This function can restore the parameters in the above table to their factory settings. When using it, K41 needs to be set to 1, set to other values are invalid.

Note:

- (1) the "from / to data initialization" function requires the firmware version of the module to be V100 or above. This function can restore the parameters in the above table to the factory settings. When using it, you need to set K41 to 1, and set to other values are invalid.
- (2) When the "Y function selection" is set to "immediate output", only the "temperature deviation value δ ", "the calibration of the ambient temperature value" is valid, and other parameters are not effective.
- (3) The module can automatically save the set temperature value, PID parameters, temperature control cycle, output range, temperature deviation and temperature calibration parameters. When writing the above parameters, the rising edge should be used to trigger the writing. It is recommended to write only the

parameters used. It is not recommended to write the whole piece of data for the convenience of programming, because writing 0 to some addresses will cause the system to fail to work.

- (4) The self-tuning enable address K0: K0 will occupy a continuous 8-bit address space. The enable bits of the 6-channel module correspond to the first 6-bit address space, and the last 2-bit addresses are idle (but cannot be used for other purposes). When the read/write enable bit is enabled, K0 can be a coil or register. When it is a coil, it occupies 8 consecutive bits starting from the coil address; When it is a register, it occupies that register. For example, to set the first and third channels of the module to self-tuning mode, and the remaining four channels to manual PID mode, with the command To K10000 K0 K1 M10, M10 and M12 should be set to ON, and M11, M13, M14, and M15 should be set to OFF; When the instruction is To K10000 K0 K1 D100, D100 should be assigned a value of 5.

15-6. Exterior connection

About the external wiring, please see the following items:

- When connect +24V power, please use 24V power on PLC main unit to avoid interference.
- To avoid interference, please use shield cable to ground.

Input connection:

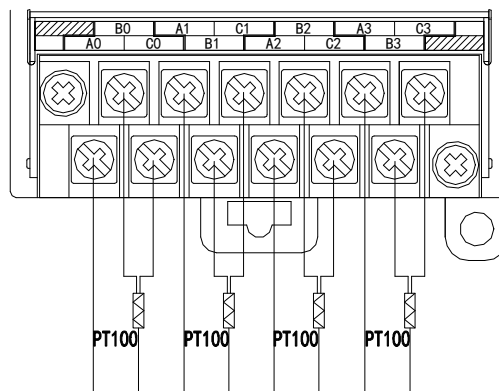

Note: For a two wires platinum thermistor, please connect one lead to the A0 end and the other lead to the C0 end, and use a wire to short circuit B0 and C0.

Output connection:

- ◆ Output terminals: transistor output terminal please choose DC 5V~30V power supply.
- ◆ Circuit insulation
PLC interior circuit and output transistor is optical insulation. Each public module is also separated.
- ◆ Response time
The time is less than 0.2ms from PLC driving (or cut) optical coupling device to transistor ON/OFF.
- ◆ Output current
Each point current is 50mA to avoid over-heat.
- ◆ Open circuit leakage current
Below 0.1mA

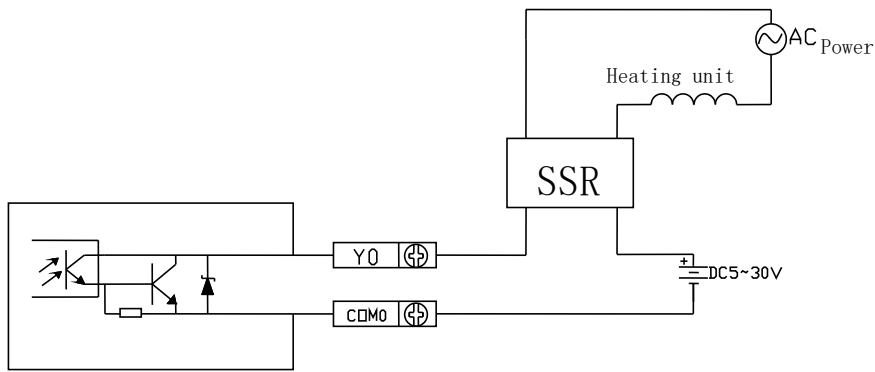

PT100 input features:

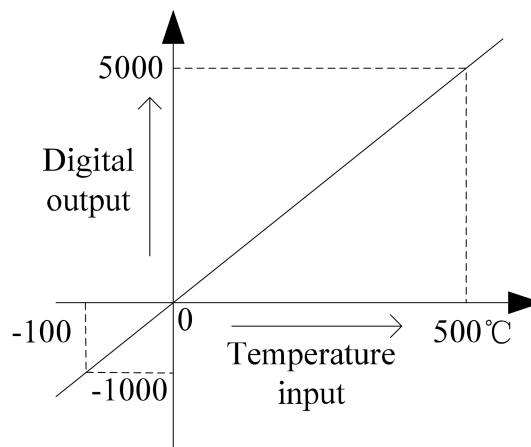

15-7. Programming

When temperature control is required, there are two programming options:

1. use the PID of the PLC body for temperature control, at this time, you need to switch the Y function selection to 'immediate output', the programming case details please refer to "XDXL PLC instruction manual" chapter 7 PID control functions.
2. use the built-in PID of the module for temperature control, at this time, you need to switch the Y function selection to "channel enable", programming cases such as shown in following example 1.

Example 1: Module 1, PID control for CH0

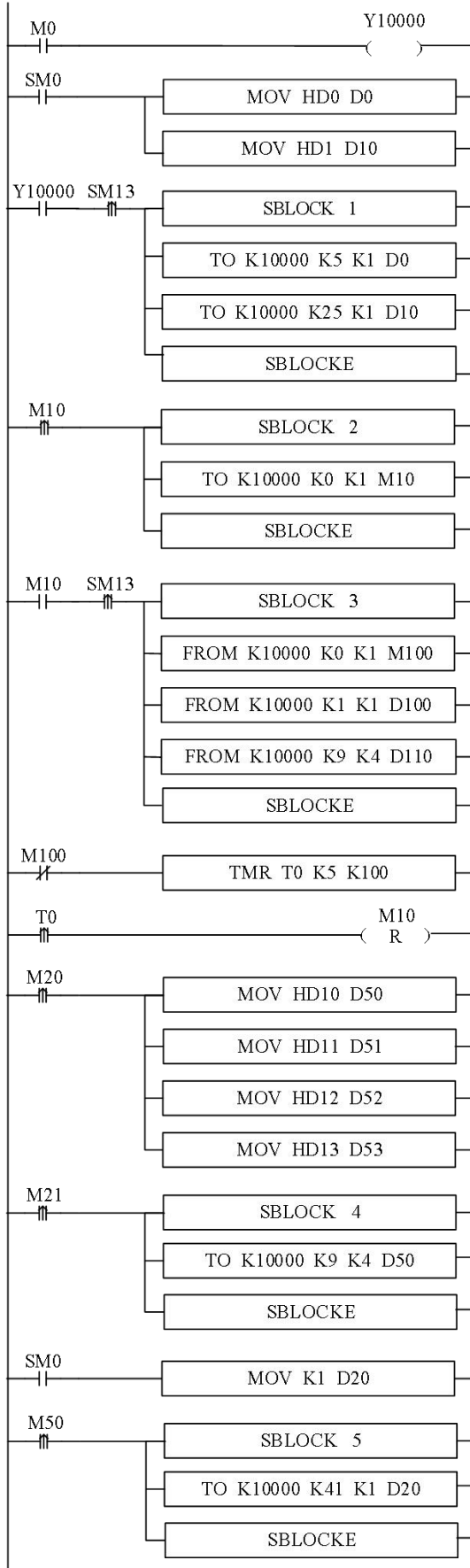

// set ON the PID enable bit

// set the target value (unit: 0.1°C)

// set temperature control cycle (unit: 0.1s)

//write in the target value, temperature control period

// write in auto-tune bit

// read auto-tune bit and PID parameters

// read auto-tune bit

// read PID output value

// read P, I, D, DIFF parameters

//after auto-tune bit reset for 0.5s, reset auto-tune flag bit

//set P value

//set I value

//set D value

//set Diff value

//manually PID control, write in PID parameters

//initialize the module parameters

Explanation:

(1) When the auto-tuning enable is turned on, the command will immediately occupy 8 bits of M10-M17 in total. M10-M13 corresponds to the auto-tuning enable of each channel. M14 and M17 have no meaning and need to be left blank.

(2) If the output is a solid state relay, the temperature control cycle is recommended to be 1 ~ 3s; if the output is a relay, the temperature control cycle is recommended to be 3 ~ 15s.

(3) Due to the inconsistency of units, the parameters of PLC main body PID and module PID cannot be used in common. The PID parameters of the PLC are in upper case and the PID parameters of the module are in lower case. The specific conversion relations are as follows: $p = P/100$; $i = I/10$; $d = D/100$.

Soft component functions:

M0	Set ON the PID enable
SM0	Set the target value, temperature control bit
M1	Write in auto-tune bit
M3	Set manually PID parameters
M4	Write-in manually PID parameters
M10	Read auto-tune bit, PID parameters, PID output
M50	Initialize the module
Y10000	PID enable bit of channel 0
D0	Set the target value
D10	Temperature control period
D80	P
D81	I
D82	D
D83	DIFF

16. Thermocouple temperature control module XD-E6TC-P(-H), XD-E2TC-P

16-1. Specification

This chapter mainly introduces the specification, thermocouple knowledge, terminal description, data address description, workflow and principle of XD-E6TC-P, XD-E6TC-P-H, XD-E2TC-P modules, as well as the instructions for reading and writing data and related programming examples.

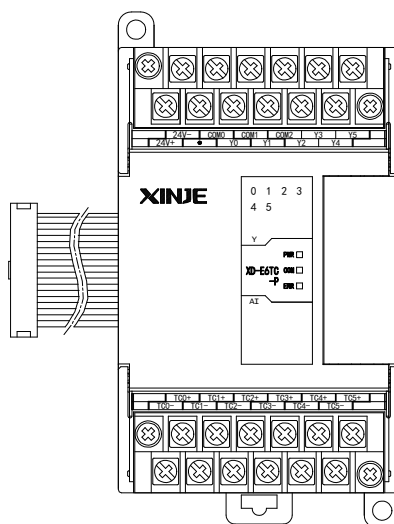

1)Features:

- ◆ Thermocouple sensor signal input
- ◆ XD-E6TC-P: 6 channels input, 6 channels output, 6 groups independent PID parameters, support self-tuning function
- ◆ XD-E6TC-P-H: 6-channel input, 6-channel output, 6 groups independent PID parameters, supporting self-tuning function, each channel is isolated, with stronger anti-interference ability, wider sampling range, and faster sampling rate
- ◆ XD-E2TC-P: 2 channels input, 2 channels output, 2 groups independent PID parameters, support self-tuning function
- ◆ Built-in cold-terminal compensation circuit
- ◆ Resolution is 0.1°C
- ◆ As the special function module of XD3/XD3E, 10 modules can be connected to the PLC. XD5/XDM/XDC/XD5E/XDME/XDH can extend 16 modules. XD1/XD2 cannot extend modules.

2)Specifications:

XD-E6TC-P, XD-E2TC-P:

Item	Contents	
Analog signal input	Thermocouple K, S, E, N, B, T, J, R	
Temperature measurement range	K	-200.0°C~1300.0°C
	S	0.0°C~1700.0°C
	E	-200.0°C~600.0°C
	N	-200.0°C~1200.0°C

Item	Contents	
	B	250.0°C~1700.0°C (shows 0 below 250°C)
	T	-200.0°C~400.0°C
	J	-200.0°C~800.0°C
	R	0.0°C~1700.0°C
Digital output range	Mini temperature measurement value * 10 ~ Max temperature measurement value * 10 Take type K as an example, the digital output range is -2000~13000)	
Resolution	0.1°C	
Integrate precision	±1% (relative max value)	
Conversion speed	XD-E6TC-P	480ms/6 channels
	XD-E2TC-P	160ms/2 channels
Power supply	DC24V±10%, 50mA	
Installation mode	Fixed with M3 screws or directly installed on orbit of DIN46277 (Width: 35mm)	
Dimension	63mm×108mm×89.9mm	

Note:

1. If no signal input, the channel data is -1.
2. According to the actual requirement to connect the thermocouple.
3. The cover of device which installs thermocouple should be connected to the ground.

XD-E6TC-P-H:

Item	Contents	
Analog signal input	Thermocouple K, S, E, N, B, T, J, R	
Temperature measurement range	K	-200.0°C~1372.0°C
	S	-50.0°C~1768.0°C
	E	-200.0°C~1000.0°C
	N	-200.0°C~1300.0°C
	B	-250.0°C~1798.0°C
	T	-200.0°C~400.0°C
	J	-210.0°C~1200.0°C
	R	-50.0°C~1768.0°C
Digital output range	Mini temperature measurement value *10~Max temperature measurement value * 10 (Take type K as an example, the digital output range is -2000~13720)	
Resolution	0.1°C	
Integrate precision	±1% (relative max value)	
Conversion speed	80ms/full channels	
Power supply	DC24V±10%, 50mA	
Installation mode	Fixed with M3 screws or directly installed on orbit of DIN46277 (Width: 35mm)	
Dimension	63mm×108mm×89.9mm	

When the module is in an abnormal state, the ID1xxxx register will display corresponding abnormal values. Even if the disconnection detection is disabled in the module configuration, the abnormal values will still be displayed. The abnormal values for different types of alarms are as follows

- When the 24V power supply of the module is disconnected, all channel data is -2.
- When the thermocouple temperature control module is not connected to a sensor, its channel data is -1.
- When the sensor signal is below the lower limit of the measurement range, its channel data is the minimum value of the digital output range of the selected sensor type.
(Note: The range of XD-E6TC-P-H and XD-EnTC-P is different.)
- When the sensor signal is higher than the upper limit of the measurement range, its channel data is the maximum value of the digital output range of the selected sensor type.
(Note: The range of XD-E6TC-P-H and XD-EnTC-P is different.)
- Due to the isolation processing of each channel in XD-E6TC-P-H, multiple channels can be sampled simultaneously, resulting in a faster sampling rate.
- Negative temperature detection function, XD-E6TC-P module requires version V16 and above, XD-E2TC-P module requires version V15 and above. All versions of XD-E6TC-P-H module are supported.

16-2. Terminals

	24V-	COM0	COM1	COM2	Y3	Y5
24V+	•	Y0	Y1	Y2	Y4	
	TC0+	TC1+	TC2+	TC3+	TC4+	TC5+
	TC0-	TC1-	TC2-	TC3-	TC4-	TC5-

Channel	Terminal	Signal
Power supply	24V+	+24V power supply
	24V-	Common terminal of power supply
CH0	TC0+	CH0 thermocouple input +
	TC0-	CH0 thermocouple input -
CH1	TC1+	CH1 thermocouple input +
	TC1-	CH1 thermocouple input -
CH2	TC2+	CH2 thermocouple input +
	TC2-	CH2 thermocouple input -
CH3	TC3+	CH3 thermocouple input +
	TC3-	CH3 thermocouple input -
CH4	TC4+	CH4 thermocouple input +
	TC4-	CH4 thermocouple input -
CH5	TC5+	CH5 thermocouple input +
	TC5-	CH5 thermocouple input -
Output terminal	COM0	CH0 output common terminal
	Y0	CH0 output terminal
	COM1	CH1 output common terminal
	Y1	CH1 output terminal
	COM2	CH2, CH3, CH4, CH5 output common terminal

Channel	Terminal	Signal
	Y2	CH2 output terminal
	Y3	CH3 output terminal
	Y4	CH4 output terminal
	Y5	CH5 output terminal

Note: XD-E2TC-P only has two channels CH0 and CH1.

16-3. Example of Input/Output Wiring

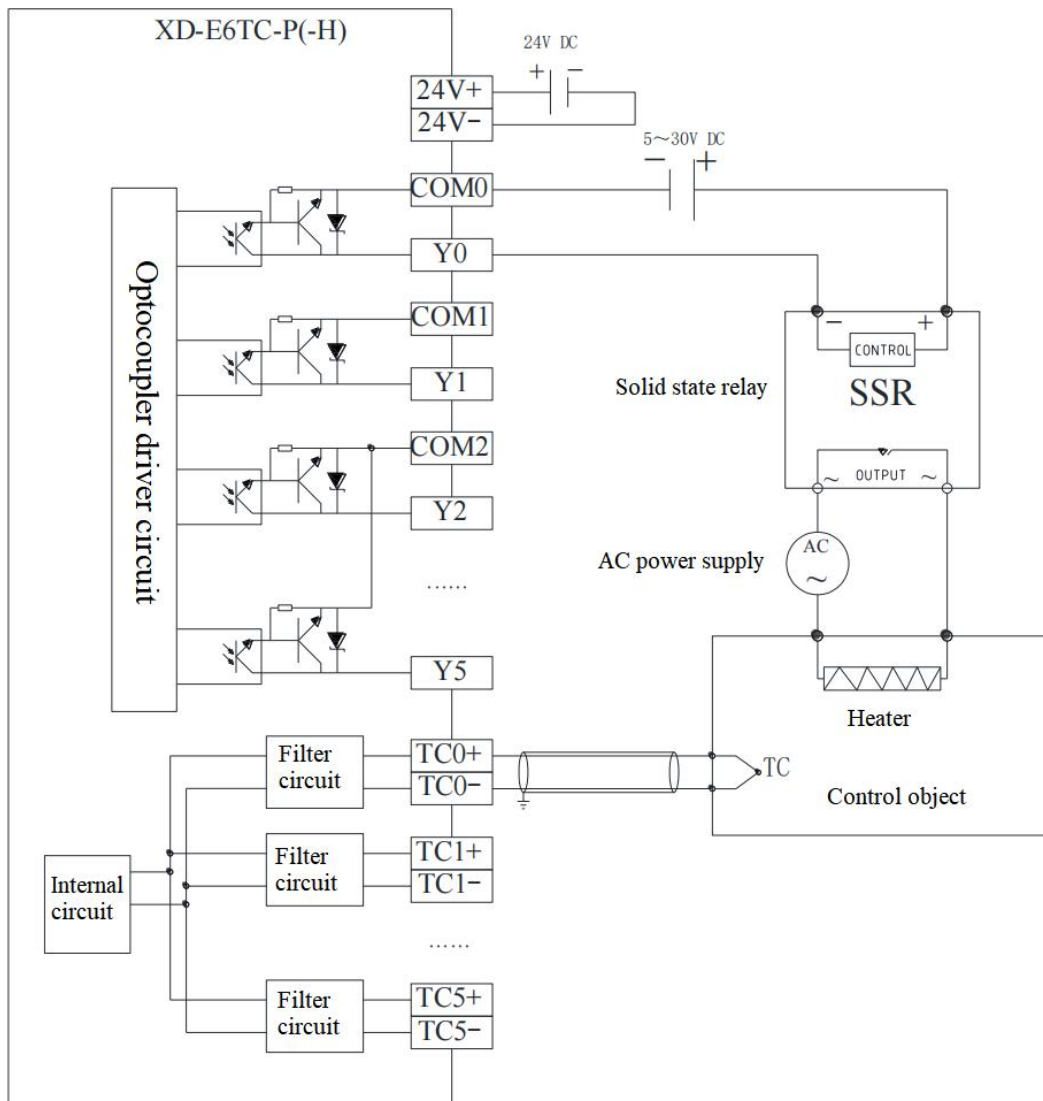

- Output terminal: transistor output terminal, please choose a stable power supply of DC5V~30V.
- Circuit insulation: Optocouplers are used for optical insulation between the internal circuits and output transistors of PLC, and each common module is also separated from each other.
- Response time: The time from PLC driving (or disconnecting) the optocoupler to the transistor ON/OFF shall not exceed 0.2ms.
- Output current: To limit temperature rise, it supports a maximum output load of 50mA.

- Open circuit leakage current: below 0.1mA.

Notes:

1. When connecting an external 24V power supply, please use the 24V power supply on the PLC body to avoid interference.
2. The casing of the temperature sensor installation equipment must be grounded
3. To avoid interference, temperature sensors should use shielded wires and ground the shielding layer to a single point.
4. When the "Cold End Compensation Method Selection" is set to "Internal Compensation", the thermocouple cold end is the terminal block on the module and needs to be extended with extension wires of the same material or dedicated compensation wires, otherwise it will affect the measurement accuracy

16-4. I/O address assignment

XD series analog module will not occupy I/O unit; the conversion value will be sent to PLC register. Each channel related PLC register address are shown as below:

Parameters	Explanation				
	Channel	Ch0	Ch1	Ch5
Display temperature Unit: 0.1 °C	Module 1	ID10000	ID10001	ID1000×	ID10005
	Module 2	ID10100	ID10101	ID10X0×	ID10105
	ID10X00	ID10X01	ID10X0×	ID10X05
	Module 16	ID11500	ID11501	ID1150×	ID11505
Enable signal (0: OFF, 1:ON)	Module 1	Y10000	Y10001	Y1000×	Y10005
	Module 2	Y10100	Y10101	Y1010×	Y10105
	Y1××00	Y1××01	Y1××0×	Y1××05
	Module 16	Y11700	Y11701	Y1170×	Y11705
	<p>When the "Y function selection" is set to "immediate output", Y0~Y5 are ordinary switch output terminals, and Y10000~Y10005 (taking # 1 module as an example) can be used to directly control the Y0~Y5 outputs on the module;</p> <p>When the "Y function selection" is set to "channel enable", Y0~Y5 are the PID output terminals, and Y10000~Y10005 (taking # 1 module as an example) can be used to enable the corresponding channel's PID control. The Y0~Y5 outputs on the module are automatically calculated and controlled by the PID.</p>				
PID output (return to the X input of PLC)	Module 1	X10000	X10001	X1000×	X10005
	Module 2	X10100	X10101	X1010×	X10105
	X10×00	X10×01	X10×0×	X10×05
	Module 16	X11700	X11701	X1170×	X11705
	<p>When the "Y function selection" is set to "channel enable", Y10000-Y10005 (taking # 1 module as an example) is the PID enable bit, and the PID duty cycle output needs to be monitored from X10000 to X10005 (taking # 1 module as an example).</p>				
Connection state of thermocouple (0 is connection, 1	Module 1	X10010	X10011	X1001×	X10015
	Module 2	X10110	X10111	X1011×	X10115
	X10××0	X10××1	X10×××	X10××5

is disconnection)	Module 16	X11710	X11711	X1171×	X11715
PID auto-tune	Module 1	X10020	X10021	X1002X	X10025
error signal bit(0	Module 2	X10120	X10121	X1012×	X10125
is normal, 1 is	X1××20	X1××21	X1××2×	X1××25
error)	Module 16	X11720	X11721	X1172×	X11725

16-5. Working mode

There are two ways to set the working mode:

1. XDPpro software
2. Flash registers of PLC

1) XDPpro software configuration:

Open the XDPpro software, click configure/expansion module settings:

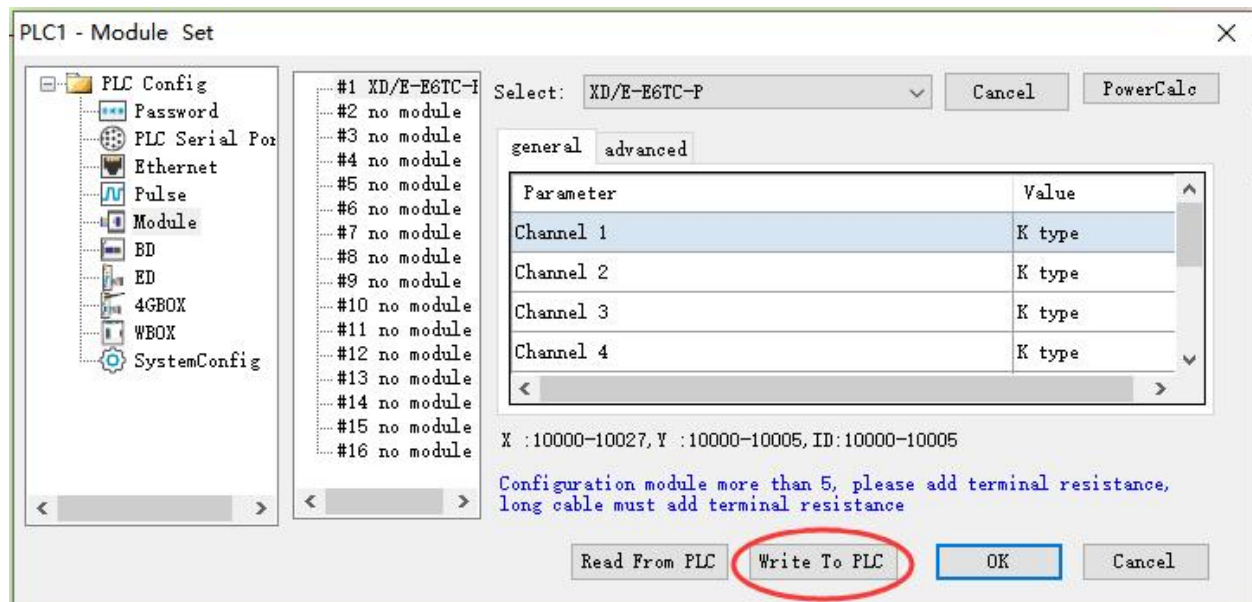
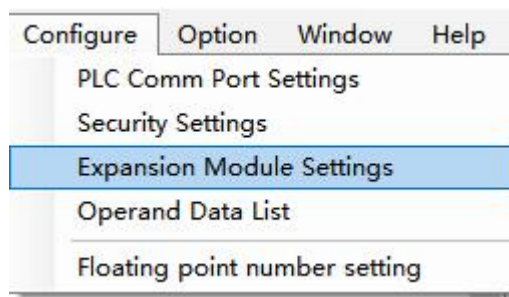

Step 1: Choose the model, note :XD-E6TC-P-H choose XD/E-E6TC-P

Step 2: Choose the corresponding thermocouple model (supporting 8 types of thermocouples), wire breakage detection switch, Y function selection, fixed value compensation method, and fixed value compensation temperature.

Step 3: After the configuration is complete, click on "Write to PLC", then click "OK", and then download the user program. After running the program, this configuration will take effect.

The Y Function Selection is used to specify the function of Y10000 to Y10005 (# 1 module as an example), By default, Support the self-setting and PID control functions of the module itself, The output points Y 0 to Y 5 on the module are affected by the PID output value and produce the on / break effect; When set to Output Now, The output points Y 0 to Y 5 on the module will be used as the ordinary switching volume output point, Position Y10000~Y10005 can guide Y0~Y5, The module only retains the temperature acquisition function, If you need the temperature control function, please use PLC, the PID instruction of the ontology.

- The "Y Function Selection" is used to specify the functions of Y10000~Y10005 (taking module # 1 as an example). It defaults to "Channel Enable" at the factory and supports the module self-tuning and PID control functions. The output points Y0~Y5 on the module are affected by the PID output value and can be turned on/off. When set to "immediate output", the output points Y0~Y5 on the module will be used as ordinary switch output points. Setting Y10000~Y10005 will set Y0~Y5, while the module only retains temperature acquisition function. If temperature control function is required, please use the PID command of the PLC body.
- A thermocouple consists of two wires made of different metals or metal alloys. The ends of the two wires are welded together, and the welding point is called the temperature measurement point. The other end of the two wires is open, and this end is called the cold end.

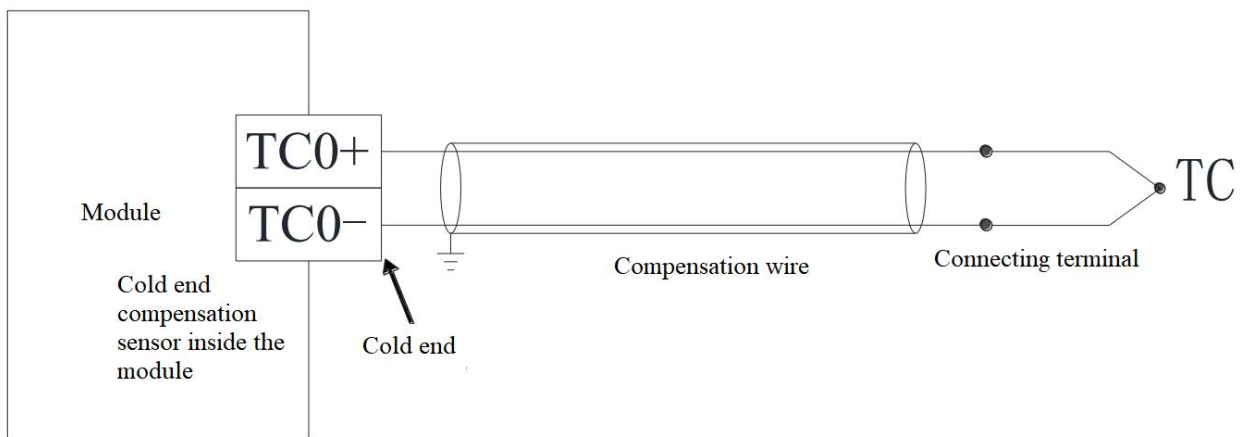

- The module provides two cold end compensation methods: "internal compensation" and "fixed value compensation". "Cold end compensation method selection" is used to switch the cold end compensation method. The default at the factory is "internal compensation", and the cold end temperature is collected by the module's built-in cold end sensor. When set to "fixed value compensation", the cold end temperature adopts the set "fixed value compensation temperature", which defaults to 250 (25.0 °C) and has a setting range of -1000~1000. However, it should be noted that the set "fixed value compensation temperature" must be consistent with the actual temperature at the location of the cold end.

Note:

- 1) XD-E6TC-P-H :The 'fixed value compensation" function requires firmware version V2 or above
- 2) XD EnTC-P: The "fixed value compensation" function requires firmware version V15 or above
- 3) XD-E6TC-P-H: 24V power supply detection function requires firmware version V3 or above.
- 4) XD EnTC-P: 24V power supply detection function requires firmware version V16 or above.

2)Flash registers:

Set the thermocouple type through SFD registers of PLC:

Module no.	SFD address	Module no.	SFD address
#1	SFD350~SFD359	#9	SFD430~SFD439
#2	SFD360~SFD369	#10	SFD440~SFD449
#3	SFD370~SFD379	#11	SFD450~SFD459
#4	SFD380~SFD389	#12	SFD460~SFD469
#5	SFD390~SFD399	#13	SFD470~SFD479
#6	SFD400~SFD409	#14	SFD480~SFD489
#7	SFD410~SFD419	#15	SFD490~SFD499
#8	SFD420~SFD429	#16	SFD500~SFD509

3)SFD bit definition:

Expansion module no.1 setting:

Register		Bit7	Bit6	Bit5	Bit4	Bit3	Bit2	Bit1	Bit0
SFD350	Byte0	TC2				TC1			
		K: 0000				K: 0000			
		S: 0001				S: 0001			
		E: 0010				E: 0010			
		N: 0011				N: 0011			
		J: 0100				J: 0100			
		T: 0101				T: 0101			
		R: 0110				R: 0110			
	B: 0111				B: 0111				
	Byte1	TC4				TC3			
K: 0000				K: 0000					
S: 0001				S: 0001					
E: 0010				E: 0010					
N: 0011				N: 0011					
R: 0110				R: 0110					

Register		Bit7	Bit6	Bit5	Bit4	Bit3	Bit2	Bit1	Bit0
		B: 0111				B: 0111			
SFD351	Byte2	TC6				TC5			
		K: 0000 S: 0001 E: 0010 N: 0011 J: 0100 T: 0101 R: 0110 B: 0111				K: 0000 S: 0001 E: 0010 N: 0011 J: 0100 T: 0101 R: 0110 B: 0111			
	Byte3	-							
SFD352	Byte4	-	Cold end compensation method selection: 00: Internal compensation 01: Fixed value compensation		TC channel disconnection/power detection switch 00:ON 01:OFF		Y Function Selection 00:Channel Enable 01:Output immediately		
	Byte5	-							
SFD353	Byte6	Fixed value compensation temperature (unit: 0.1 °C, set range: -1000~1000, default: 250)							
	Byte7								
SFD354	Byte8	TC1 filtering coefficient (0 without filtering, 1-254 filtering intensity gradually decreases, default 0)							
	Byte9	TC2 filtering coefficient (0 without filtering, 1-254 filtering intensity gradually decreases, default 0)							
SFD355	Byte10	TC3 filtering coefficient (0 without filtering, 1-254 filtering intensity gradually decreases, default 0)							
	Byte11	TC4 filtering coefficient (0 without filtering, 1-254 filtering intensity gradually decreases, default 0)							
SFD356	Byte12	TC5 filtering coefficient (0 without filtering, 1-254 filtering intensity gradually decreases, default 0)							
	Byte13	TC6 filtering coefficient (0 without filtering, 1-254 filtering intensity gradually decreases, default 0)							
-	-	-							
SFD358~SFD359		Reserved							

Note: XD-E2TC-P only has two channels TC0 and TC1.

16-6. From/To instruction

1) Instruction Description

The reading and writing of the thermocouple temperature control module needs to be completed through the FROM/TO instruction in the Sequence function block BLOCK, as shown in the following figure

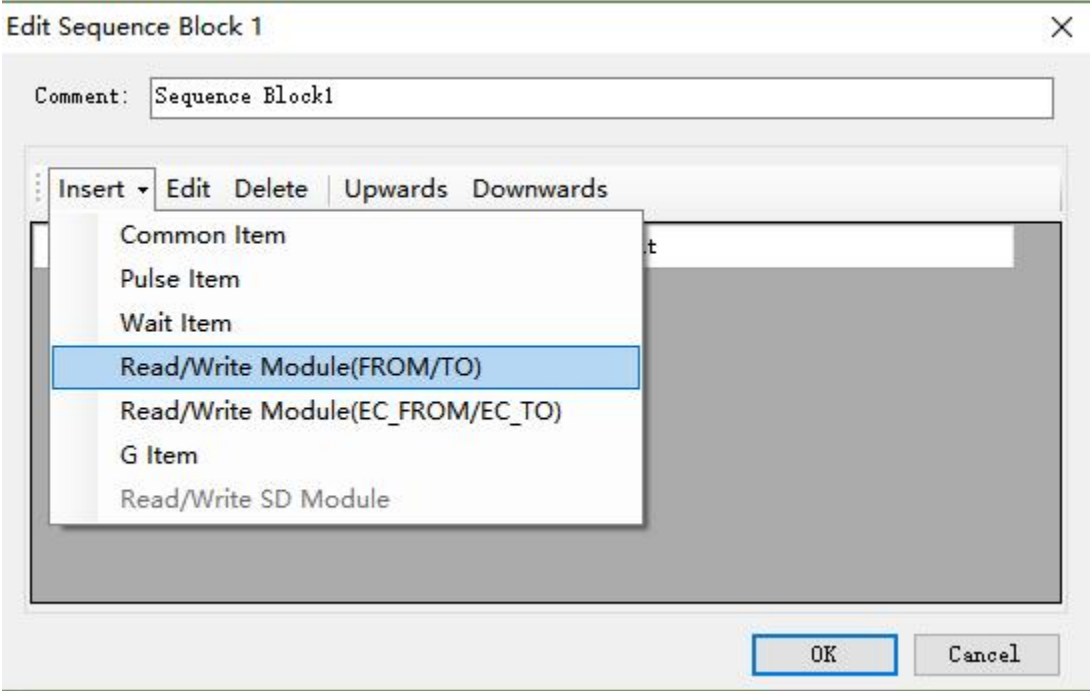

(a) Insert FROM/TO module

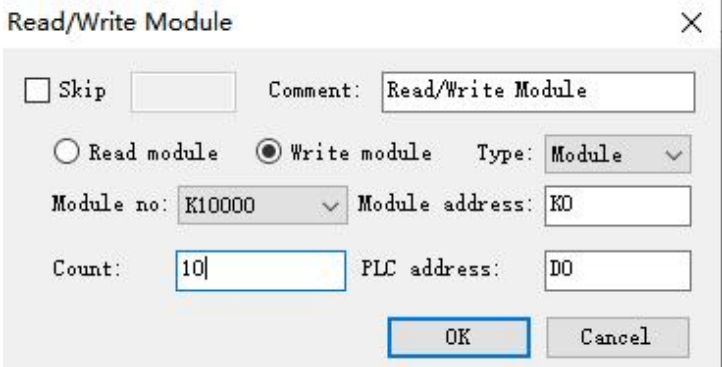

(b) Write instruction

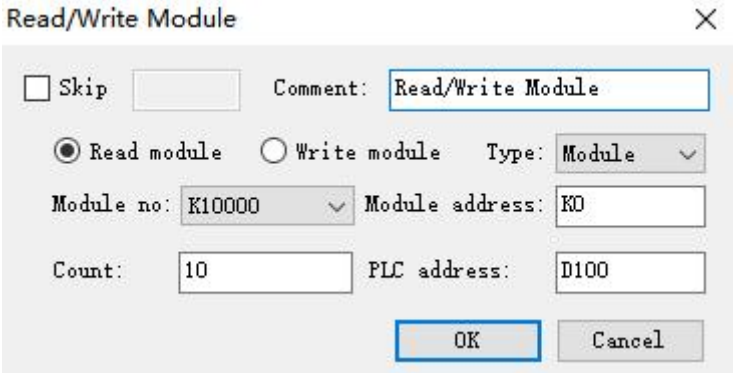

(c) Read instruction

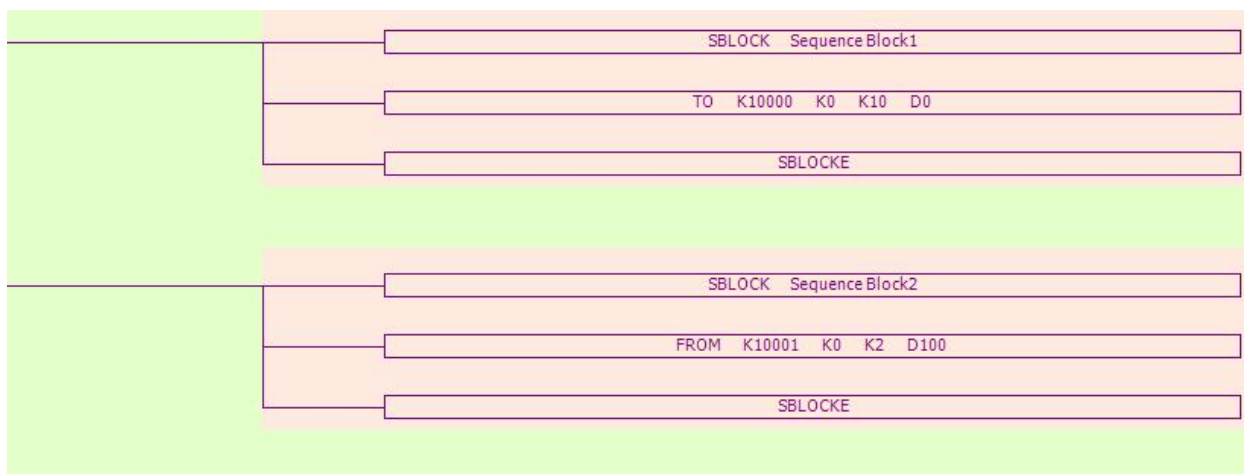

(d) Ladder chart

Instructions introduction

- Parameter write instruction TO



Function: write the PLC register data to module address, the operate unit is word.

Operand:

S1: target module number, range: 10000~10015. Operand: K, TD, CD, D, HD, FD

S2: first address of module. Operand: K, TD, CD, D, HD, FD

S3: write in register numbers. Operand: K, TD, CD, D, HD, FD

D1: first address of PLC. Operand: TD, CD, D, HD, FD

- Parameter read instruction FROM



Function: read the module data to the PLC register, the operate unit is word.

S1: target module number, range: 10000~10015. Operand: K, TD, CD, D, HD, FD

S2: first address of module. Operand: K, TD, CD, D, HD, FD

S3: read register numbers. Operand: K, TD, CD, D, HD, FD

D1: first address of PLC. Operand: TD, CD, D, HD, FD

Note:

1: FROM/TO instruction can only be written in sequence function block, XD series PLC with firmware version less than v3.4.5 only allows up to 8 block function blocks; XD / XL series PLC with firmware version v3.4.5 and above can write up to 100 blocks in the program, but can only run up to 8 blocks at the same time.

2: The starting number of module starts from K10000, K10000 for # 1 module and k10001 for # 2 module. By analogy, # 16 module is K10015.

3: In v3.3 and below version software, the module number range is K0~K15. Please pay attention to the modification when transferring projects in different versions of software.

2)Related address definition:

The address of the read/write parameters:

XD-E6TC-P/XD-E6TC-P-H:

From_To data		Default value	CH1	CH2	CH3	CH4	CH5	CH6	R/W
Auto-tune enable		0	K0	K0	K0	K0	K0	K0	RW
PID output (0~4095)		-	K1	K2	K3	K4	K5	K6	R
Setting temperature (unit: 0.1°C)		0	K7	K8	K9	K10	K11	K12	RW
PID	Kp	40	K13	K17	K21	K25	K29	K33	RW
	Ki	240	K14	K18	K22	K26	K30	K34	RW
	Kd	60	K15	K19	K23	K27	K31	K35	RW
	Diff (unit: 0.1°C)	1000	K16	K20	K24	K28	K32	K36	RW
Temperature control period (unit: 0.1s)		20	K37	K38	K39	K40	K41	K42	RW
Output range (0~100)		100	K43	K44	K45	K46	K47	K48	RW
Temperature deviation δ (unit: 0.1°C)		0	K49	K50	K51	K52	K53	K54	RW
Calibration ambient temperature (unit: 0.1°C)		-	K55	K56	K57	K58	K59	K60	W
From/To data initialization		-	K61	K61	K61	K61	K61	K61	W

XD-E2TC-P:

From/To data		Default value	CH1	CH2	R/W
Auto-tune enable		0	K0	K0	RW
PID output (0~4095)		-	K1	K2	R
Setting temperature (unit: 0.1°C)		0	K3	K4	RW
PID	Kp	40	K5	K9	RW
	Ki	240	K6	K10	RW
	Kd	60	K7	K11	RW
	Diff (unit: 0.1°C)	1000	K8	K12	RW
Temperature control period (unit: 0.1s)		20	K13	K14	RW
Output range (0~100)		100	K15	K16	RW
Temperature deviation δ (unit: 0.1°C)		0	K17	K18	RW
Calibration ambient temperature (unit: 0.1°C)		-	K19	K20	W
From/To data initialization		-	K21	K21	W

Related parameters	Description
Self tuning enable	<p>Auto-tune triggered signal, start to auto-tune mode when set to 1 After auto-tune, PID parameters and temperature control period value are refreshed, the bit value is cleared to be 0. The user can read the bit to know the state. 1 means auto-tune is ongoing. 0 means auto-tune has finished.</p> <p>The self-tuning enable signal enters the self-tuning phase when set to 1. After self-tuning, the PID parameter values and temperature control cycle values are refreshed, and the enable position is automatically cleared to 0. Users can also read its status. When it is 1, it indicates that it is in the self-tuning process, and when it is 0, it indicates that it has not been performed Self tuning or self-tuning has ended. The self-tuning uses the critical oscillation method.</p>
PID output (0~4095)	<p>Digital quantity output range is 0~4095. When the PID output is analog quantity (such as steam valve open degree or silicon-controlled conduction angle), the value can be transmitted to the analog quantity output module in order to realize the control demand.</p>
Set temperature (Unit: 0.1°C)	<p>The target temperature of the control system. The set range is the value corresponding to the upper and lower temperature limits of the selected thermocouple type</p>
PID parameters (P, I, D)	<p>The best PID parameters got from the PID auto-tune. If the current PID parameters cannot meet the control requirements, users can set the experience PID parameters to make the module work according to the user setting value.</p>
PID calculation range (Diff) Unit: 0.1°C	<p>PID arithmetic is effective in the range of T (setting temperature) \pmDiff. In real temperature control environment, when the temperature is lower than T- Diff, the PID output is the maximum value; when the temperature is higher than T+Diff, the PID output is 0. Assuming: the calculation range is T_{diff}, the setting temperature is T_{set}, and the displayed temperature is T. When $T_{set} - T_{diff} \leq T \leq T_{set} + T_{diff}$, the output is controlled by PID calculation. When $T \leq T_{set} - T_{diff}$, the output is the maximum value. When $T_{set} + T_{diff} \leq T$, the output is 0.</p>
Temperature control period (Unit: 0.1s)	<p>The temperature control period range from 0.5 to 200 seconds, the minimum precision is 0.1 second. The set value = real value \times 10. For example: if the real temperature control period is 0.5 seconds, user should set 5 seconds in the module.</p>
Output level	<p>The auto-tune output unit is percent. 100 means the duty ratio is 100% of the full-scale output, 80 means the duty ratio is 80% of the full-scale output.</p>
Temperature deviation δ (Unit: 0.1°C)	<p>(sampling temperature value + temperature deviation δ) / 10 = display temperature. This parameter is a sign value with the unit of 0.1°C, the value is retained when the power is cut off, the defaulted value is 0.</p>
Calibration ambient temperature (Unit: 0.1°C)	<p>If user realizes that the environment temperature is different from display temperature, they can write the correct environment temperature into the module. Then the module will calculate the temperature difference δ and save it. Temperature difference δ = calibration ambient temperature – sampling temperature. Unit: 0.1°C. For example, under the caloric balance condition, users measured the environment</p>

	<p>temperature is 60 °C with mercury thermometer, but the display temperature is 55°C (sampling temperature is 550), temperature difference δ is 0. At this time, users can set the parameter to be 600, then the temperature difference δ is 50 (5 °C).</p> <p>Display temperature = (550 + 50) / 10 = 60 °C.</p> <p>**Attention: when setting the adjusting environment temperature, make sure it is the same as environment temperature. It is very important because the incorrect parameter will result in mistake of calculating temperature difference δ and affect the display temperature.</p>
From/To data initialization	This function can restore the parameters in the above table to their factory settings. When using it, it is necessary to set K61 or K21 to 1, which is invalid for other values.

Note:

- (1) the "from / to data initialization" function requires the firmware version of the XD-EnTC-P module to be V10 or V104 and higher or the module is XD-E6TC-P-H. This function can restore the parameters in the above table to the factory settings. When using it, you need to set K61 or K21 to 1, and set to other values are invalid.
- (2) When the "Y function selection" is set to "immediate output", only the "temperature deviation δ ", "calibration ambient temperature value" is valid, and other parameters are not effective.
- (3) The module can automatically save the set temperature value, PID parameters, temperature control cycle, output range, temperature deviation and temperature calibration parameters. When writing the above parameters, the rising edge should be used to trigger the writing. It is recommended to write only the parameters used. It is not recommended to write the whole piece of data for the convenience of programming, because writing 0 to some addresses will cause the system to fail to work.
- (4) The self-tuning enable address K0: K0 will occupy a continuous 8-bit address space. The enable bits of the 6-channel module correspond to the first 6-bit address space, and the last 2-bit addresses are idle (but cannot be used for other purposes). When the read/write enable bit is enabled, K0 can be a coil or register. When it is a coil, it occupies 8 consecutive bits starting from the coil address; When it is a register, it occupies that register. For example, to set the first and third channels of the module to self-tuning mode, and the remaining four channels to manual PID mode, with the command To K10000 K0 K1 M10, M10 and M12 should be set to ON, and M11, M13, M14, and M15 should be set to OFF; When the instruction is To K10000 K0 K1 D100, D100 should be assigned a value of 5.

16-7. Exterior connection

About the exterior connection, please pay attention to the following items:

- When connect to +24V power, please use the 24V power supply of PLC to avoid interference.
- To avoid interference, shielding measure is necessary for signal cables.

Input connection:

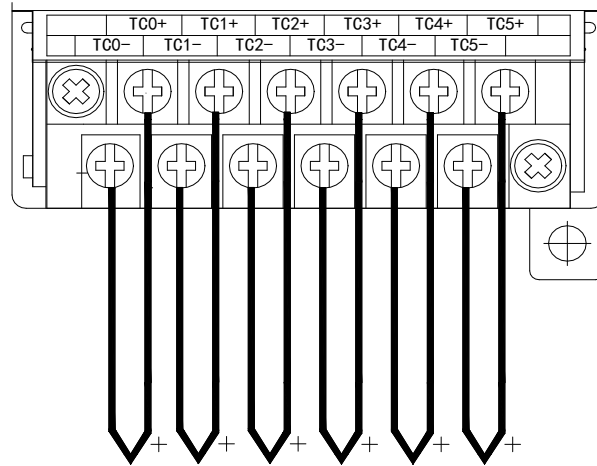

Output circuit:

- Output terminal
For transistor output terminals, please use DC5V~30V power supply.
- Circuit insulation
PLC internal circuit and output transistor is optical insulation with optical coupling device. Each public module is separate.
- ◆ Response time
The time is less than 0.2ms from PLC driving (or cut) optical coupling circuit to transistor ON/OFF.
- ◆ Output circuit
Each point current is 50mA to avoid over-heating.
- ◆ Open circuit leak current
Below 0.1mA.

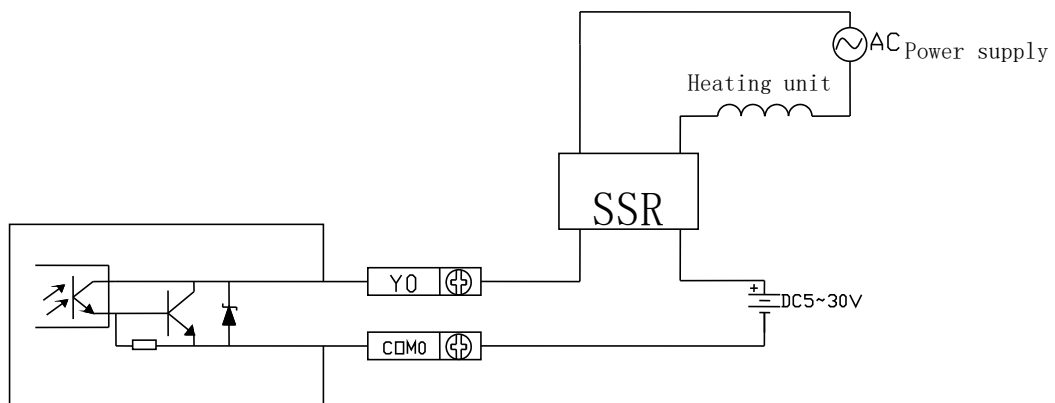

Optocoupler driver circuit

16-8. Programming

When temperature control is required, there are two programming options:

- 1, use the PID of the PLC body for temperature control, at this time, you need to switch the Y function selection to 'immediate output', the programming case details please refer to "XDXL PLC instruction manual" chapter 7 PID control functions.
- 2, use the built-in PID of the module for temperature control, at this time, you need to switch the Y function selection to "channel enable", programming cases such as shown in following example 1.

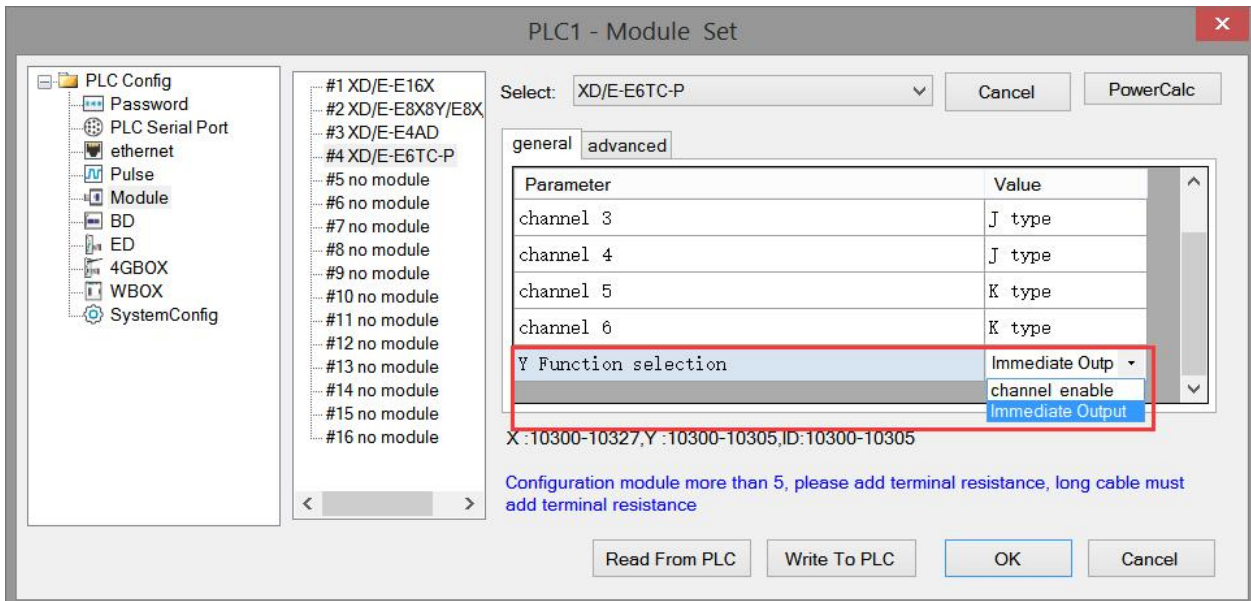

Example 1: programming for the first channel.

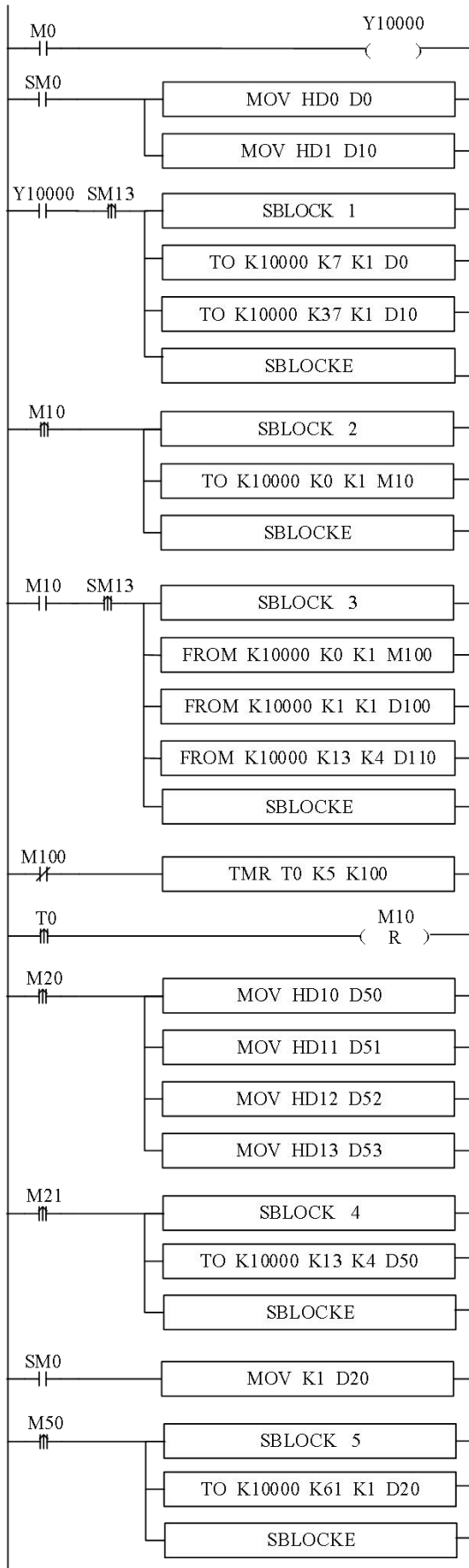

// set ON the PID enable bit

// set the target value (unit: 0.1°C)

// set temperature control cycle (unit: 0.1s)

//write in the target value, temperature control period

// write in auto-tune bit

// read auto-tune bit and PID parameters

// read auto-tune bit

// read PID output value

// read P, I, D, DIFF parameters

//after auto-tune bit reset for 0.5s, reset auto-tune flag bit

//set P value

//set I value

//set D value

//set Diff value

//manually PID control, write in PID parameters

//initialize the module parameters

Explanation:

(1) When the auto-tuning enable is turned on, the command will immediately occupy 8 bits of M10-M17 in total. M10-M15 corresponds to the auto-tuning enable of each channel. M16 and M17 have no meaning and need to be left blank.

(2) If the output is a solid state relay, the temperature control cycle is recommended to be 1 ~ 3s; if the output is a relay, the temperature control cycle is recommended to be 3 ~ 15s.

(3) Due to the inconsistency of units, the parameters of PLC main body PID and module PID cannot be used in common. The PID parameters of the PLC are in upper case and the PID parameters of the module are in lower case. The specific conversion relations are as follows: $p = P/100$; $i = I/10$; $d = D/100$.

Soft component functions:

M0	Set ON the PID enable
SM0	Set the target value, temperature control bit
M10	Write in auto-tune bit
M20	Set manually PID parameters
M21	Write-in manually PID parameters
M10	Read auto-tune bit, PID parameters, PID output
M50	Initialize the module
Y10000	PID enable bit of channel 0
D0	Set the target value
D10	Temperature control period
D50	P
D51	I
D52	D
D53	DIFF

17. SSI encoder detection module XD-E4SSI

17-1. Specification

This chapter mainly introduces XD-E4SSI module specifications, terminal arrangement, data address description, module configuration, external wiring and related programming examples.

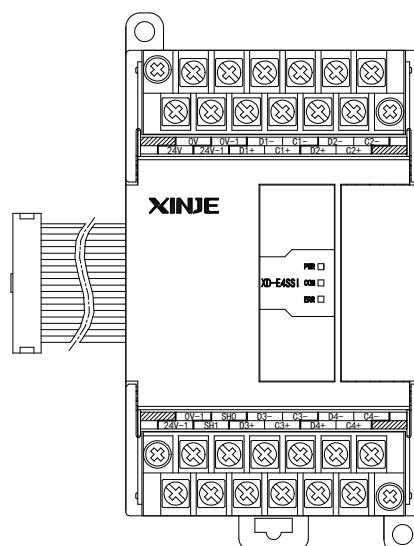

Features:

XD-E4SSI encoder detection module detects the position of absolute value encoder or position sensor, and transmits them to PLC main unit.

- ◆ Support 4-channel SSI absolute encoder position detection or 4-channel position sensor detection.
- ◆ Suitable for 10 ~ 31bits SSI encoder.
- ◆ The communication frequency of 125kHz ~ 1MHz is supported.
- ◆ Support gray code or binary format coding.
- ◆ It has the function of disconnection detection and alarm.
- ◆ As a special function module of XD series, XD3/XD3E can connect up to 10 modules on the right side of PLC main unit, XD5/XDM/XDC/XD5E/XDME/XDH can expand 16 modules, XD1/XD2 does not support expansion modules.

Specifications:

Item	Contents
Input signal	SSI absolute value encoder or position sensor signal
Power supply	DC24V (input range 20.4~28.8V)
Module consumption	1W (without load)
Position detection mode	Absolution mode
Difference between SSI data and clock signal	Accords to RS422 standards
Encoder bits	10-bit~31-bit
Digital output range	0~encoder max feedback value

Item	Contents
Resolution	1/ encoder max feedback value
Communication frequency	125KHz~1MHz
Coding type	Gray or binary coding
Integrated precision	1% (relative max value)
Conversion speed	400us per channel
Power supply for encoder	DC24V±10%, 100mA or 300mA
Length of shielded twisted pair	Communication frequency 125KHz: max 320m Communication frequency 250KHz: max 160m Communication frequency 500KHz: max 60m Communication frequency 1MHz: max 20m

17-2 Terminal explanation

Terminal arrangement:

	0V	0V-1	D1-	C1-	D2-	C2-	
	24V	24V-1	D1+	C1+	D2+	C2+	
	0V-1	SH0	D3-	C3-	D4-	C4-	
	24V-1	SH1	D3+	C3+	D4+	C4+	

Terminal signals:

Channel	Terminal	Name
CH0	D1+	Data receive +
	D1-	Data receive -
	C1+	Clock send +
	C1-	Clock send -
CH1	D2+	Data receive +
	D2-	Data receive -
	C2+	Clock send +
	C2-	Clock send -
CH2	D3+	Data receive +
	D3-	Data receive -
	C3+	Clock send +
	C3-	Clock send -
CH3	D4+	Data receive +
	D4-	Data receive -
	C4+	Clock send +
	C4-	Clock send -
Module power supply	24V	+24V power supply
	0V	Common terminal of power supply
Encoder power supply	24V-1	Supply +24V power supply to the encoder
	0V-1	Common terminal of power supply for encoder

Shielded terminal	SH0	Connect encoder shielded ground
	SH1	Connect encoder shielded ground

17-3. The assignment of I/O address

XD series analog module does not occupy the I / O unit, and the converted value is directly sent to the PLC register. The definition number of PLC register corresponding to the channel is as follows:

Note: each channel can only be used when it is enabled.

Register definition number of the first expansion module

Channel	Encoder signal (dword)	Channel enable bit	Disconnection alarm
0CH	ID10000	Y10000	X10000
1CH	ID10002	Y10001	X10001
2CH	ID10004	Y10002	X10002
3CH	ID10006	Y10003	X10003

Register definition number of the second expansion module

Channel	Encoder signal (dword)	Channel enable bit	Disconnection alarm
0CH	ID10100	Y10100	X10100
1CH	ID10102	Y10101	X10101
2CH	ID10104	Y10102	X10102
3CH	ID10106	Y10103	X10103

Register definition number of the third expansion module

Channel	Encoder signal (dword)	Channel enable bit	Disconnection alarm
0CH	ID10200	Y10200	X10200
1CH	ID10202	Y10201	X10201
2CH	ID10204	Y10202	X10202
3CH	ID10206	Y10203	X10203

Register definition number of the fourth expansion module

Channel	Encoder signal (dword)	Channel enable bit	Disconnection alarm
0CH	ID10300	Y10300	X10300
1CH	ID10302	Y10301	X10301
2CH	ID10304	Y10302	X10302
3CH	ID10306	Y10303	X10303

Register definition number of the fifth expansion module

Channel	Encoder signal (dword)	Channel enable bit	Disconnection alarm
0CH	ID10400	Y10400	X10400
1CH	ID10402	Y10401	X10401
2CH	ID10404	Y10402	X10402
3CH	ID10406	Y10403	X10403

Register definition number of the sixth expansion module

Channel	Encoder signal (dword)	Channel enable bit	Disconnection alarm
0CH	ID10500	Y10500	X10500
1CH	ID10502	Y10501	X10501
2CH	ID10504	Y10502	X10502
3CH	ID10506	Y10503	X10503

Register definition number of the seventh expansion module

Channel	Encoder signal (dword)	Channel enable bit	Disconnection alarm
0CH	ID10600	Y10600	X10600
1CH	ID10602	Y10601	X10601
2CH	ID10604	Y10602	X10602
3CH	ID10606	Y10603	X10603

Register definition number of the eighth expansion module

Channel	Encoder signal (dword)	Channel enable bit	Disconnection alarm
0CH	ID10700	Y10700	X10700
1CH	ID10702	Y10701	X10701
2CH	ID10704	Y10702	X10702
3CH	ID10706	Y10703	X10703

Register definition number of the ninth expansion module

Channel	Encoder signal (dword)	Channel enable bit	Disconnection alarm
0CH	ID10800	Y11000	X11000
1CH	ID10802	Y11001	X11001
2CH	ID10804	Y11002	X11002
3CH	ID10806	Y11003	X11003

Register definition number of the tenth expansion module

Channel	Encoder signal (dword)	Channel enable bit	Disconnection alarm
0CH	ID10900	Y11100	X11100
1CH	ID10902	Y11101	X11101
2CH	ID10904	Y11102	X11102
3CH	ID10906	Y11103	X11103

Register definition number of the eleventh expansion module

Channel	Encoder signal (dword)	Channel enable bit	Disconnection alarm
0CH	ID11000	Y11200	X11200
1CH	ID11002	Y11201	X11201
2CH	ID11004	Y11202	X11202
3CH	ID11006	Y11203	X11203

Register definition number of the twelfth expansion module

Channel	Encoder signal (dword)	Channel enable bit	Disconnection alarm
0CH	ID11100	Y11300	X11300
1CH	ID11102	Y11301	X11301
2CH	ID11104	Y11302	X11302
3CH	ID11106	Y11303	X11303

Register definition number of the thirteenth expansion module

Channel	Encoder signal (dword)	Channel enable bit	Disconnection alarm
0CH	ID11200	Y11400	X11400
1CH	ID11202	Y11401	X11401
2CH	ID11204	Y11402	X11402
3CH	ID11206	Y11403	X11403

Register definition number of the fourteenth expansion module

Channel	Encoder signal (dword)	Channel enable bit	Disconnection alarm
0CH	ID11300	Y11500	X11500
1CH	ID11302	Y11501	X11501
2CH	ID11304	Y11502	X11502
3CH	ID11306	Y11503	X11503

Register definition number of the fifteenth expansion module

Channel	Encoder signal (dword)	Channel enable bit	Disconnection alarm
0CH	ID11400	Y11500	X11500
1CH	ID11402	Y11501	X11501
2CH	ID11404	Y11502	X11502
3CH	ID11406	Y11503	X11503

Register definition number of the sixteenth expansion module

Channel	Encoder signal (dword)	Channel enable bit	Disconnection alarm
0CH	ID11500	Y11600	X11600
1CH	ID11502	Y11601	X11601
2CH	ID11504	Y11602	X11602
3CH	ID11506	Y11603	X11603

Note:

- 1: The scanning speed of input can be improved by forbidding unused channels.
- 2: When the input enable switch is turned off during operation, the corresponding input channel data will not be refreshed.
- 3: Disconnection alarm is used to detect whether the data and clock signal cables of the channel are disconnected or reversed.
- 4: When each channel is initially powered on, the ID register is 0.

17-4. Working mode

There are two ways to set the working mode:

1. XDPpro software
2. Flash registers of PLC

XDPpro software:

Open the XDPpro software, click configure/expansion module settings:

Set the model and channel parameters in the following window. Then click write to PLC.

Please restart the PLC after setting.

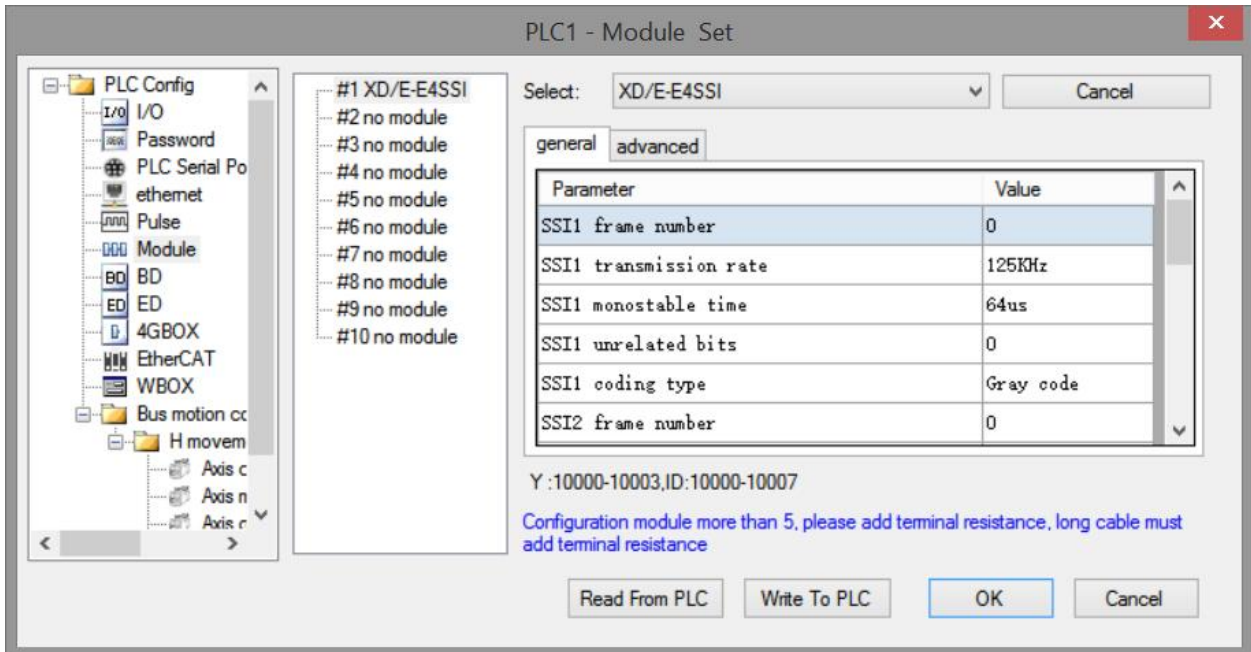

Flash registers:

The CH0 ~ CH3 channel parameters of the expansion module can be set through the special flash data register FD in PLC. As follows:

Module no.	SFD address	Module no.	SFD address
#1	SFD350~SFD359	#9	SFD430~SFD439
#2	SFD360~SFD369	#10	SFD440~SFD449
#3	SFD370~SFD379	#11	SFD450~SFD459
#4	SFD380~SFD389	#12	SFD460~SFD469
#5	SFD390~SFD399	#13	SFD470~SFD479

#6	SFD400~SFD409	#14	SFD480~SFD489
#7	SFD410~SFD419	#15	SFD490~SFD499
#8	SFD420~SFD429	#16	SFD500~SFD509

SFD definitions:

Take module 1 as an example:

Register		Bit7	Bit6	Bit5	Bit4	Bit3	Bit2	Bit1	Bit0	Note
SFD350	Byte0	SSI1 frame number (0, 10-31BIT)								
	Byte1	SSI2 frame number (0, 10-31BIT)								
SFD351	Byte2	SSI3 frame number (0, 10-31BIT)								
	Byte3	SSI4 frame number (0, 10-31BIT)								
SFD352	Byte4	-	SSI2 transmission rate			-	SSI1 transmission rate			
		X	0: 125KHz 2: 500KHz	1: 250KHz 3: 1MHz	X	0: 125KHz 2: 500KHz	1: 250KHz 3: 1MHz			
	Byte5	-	SSI4 transmission rate			-	SSI3 transmission rate			
		X	0: 125KHz 2: 500KHz	1: 250KHz 3: 1MHz	X	0: 125KHz 2: 500KHz	1: 250KHz 3: 1MHz			
SFD353	Byte6	SSI2 monostable time				SSI1 monostable time				
		0: 64us; 1: 48us; 2: 32us; 3: 16us				0: 64us; 1: 48us; 2: 32us; 3: 16us				
	Byte7	SSI4 monostable time				SSI3 monostable time				
		0: 64us; 1: 48us; 2: 32us; 3: 16us				0: 64us; 1: 48us; 2: 32us; 3: 16us				
SFD354	Byte8	-								
	Byte9	-								
SFD355	Byte10	SSI4 coding type		SSI3 coding type		SSI2 coding type		SSI1 coding type		
		0: gray code 1: binary		0: gray code 1: binary		0: gray code 1: binary		0: gray code 1: binary		
	Byte11	-								
SFD356~SFD359		-								

17-5 External connection

When external connection, pay attention to the following aspects:

- In order to avoid interference, please use shielded wire and ground the shielding layer at a single point.
- The XD-E4SSI power supply should be connected to the 24V output terminal on the PLC body as far as possible to avoid interference.
- When the module power supply is supplied by the PLC, it can output 100mA (16-point PLC) or 300 mA (24-point PLC and above) current through the 24V-1 and 0V-1 terminals. When the current exceeds this value, the encoder needs to be connected with external 24 V power supply.

Input wiring:

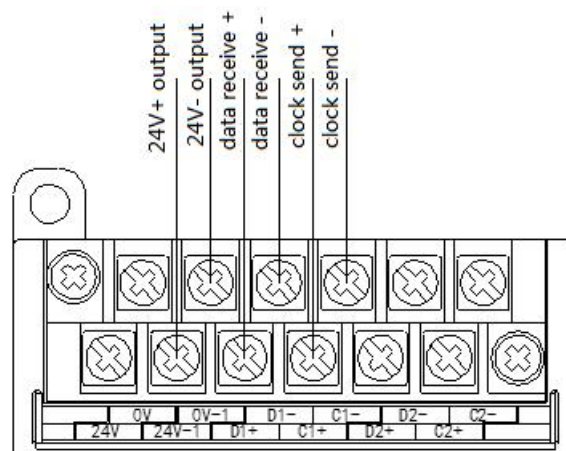

17-6 Program example

Example 1: there is one channel of position sensor needs to measure the distance (measuring range: 0-64mm; encoder number: 16 bits). Here we use the first channel of the # 1 module to measure.

The procedure is as follows:

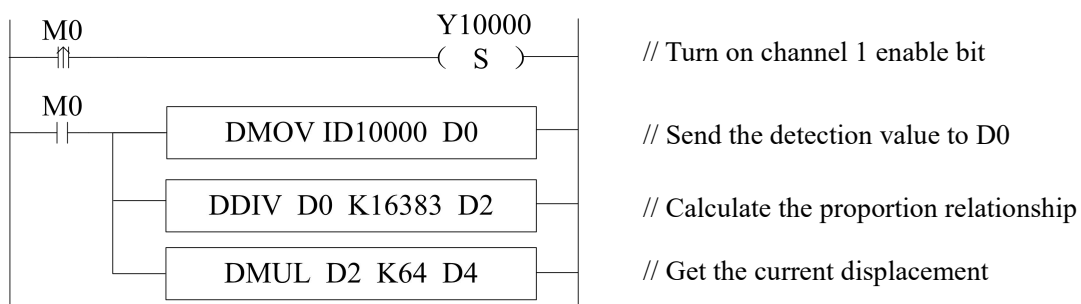

Note:

First of all, when configuring the module, please set the frame number of SSI1 to 16, and other parameters can be set by default.

The program is as shown in the figure above. Take M0 as the ranging function switch. When the rising edge of

M0 comes, turn on the first channel enable bit.

Because the frame number of SS11 is 16, the range of ID10000 is 0 ~ 65535, and the range of corresponding displacement sensor is 0 ~ 64mm. Therefore, the digital quantity can be converted into displacement through simple operation of the module.

Assuming that the number in ID10000 is 4095, the corresponding displacement is $64 \times (4095 / 65535) = 4\text{mm}$.

18. Analog extension module XD-E2AD2PT2DA

18-1. Specification

This chapter will introduce the XD-E2AD2PT2DA module specification, terminal and I/O assignment, working mode, external wiring, AD diagram and programming example.

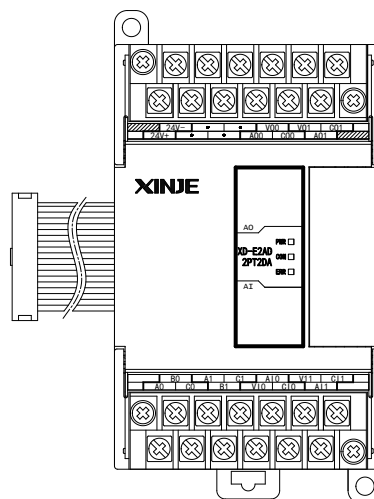

Features:

XD-E2AD2PT2DA analog expansion module converts two channels of analog input values into digital values, processes two PT100 temperature signals, converts two channels of digital values into analog values, and transmits them to PLC main unit for real-time data interaction with PLC main unit.

- It has 2 channels of 16-bit precision analog input, 2-channel PT100 temperature input and 2-channel 10-bit precision analog output.
- Current and voltage are optional, and current is 0-20mA and 4-20mA; voltage is 0-5V and 0-10V, which is set by upper computer.
- As an extension module of XD series, XD3/XD3E series can connect up to 10 modules; XD5/XDM/XDC/XD5E/XDME/XDH series can connect up to 16 modules (not supported by XD1/XD2 series)

Specifications:

Item	Analog input (AD)		Temperature input (PT)	Analog output (DA)	
	Voltage input (V)	Current input (mA)		Voltage output (V)	Current output (mA)
Analog input range	0~5,0~10V (impedance > 1M)	0~20,4~20mA (impedance is about 120Ω)	-100~500°C	—	
Max input range	DC 0~15V	20~40mA	—		
Analog output range	—		—	0~5, 0~10V External load resistor 2KΩ~1MΩ	0~20, 4~20mA External load resistor < 500Ω
Digital input range	—		—	10-bit binary (0~1023)	
Digital output range	16-bit binary (0~65535)		-1000~5000	—	
Resolution	1/65535(16Bit)		0.1°C	1/1023(10Bit)	
Integrated precision	±0.8%		±1% (relative max value)	±1%	
Conversion speed	2ms per channel			2ms per channel	
Module power supply	DC24V±10%, 150mA				

18-2. Terminals

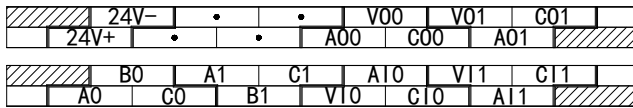

Channel	Terminal	Signal name
CH0	A10	Current input
	V10	Voltage input
	C0	CH0 common terminal of analog input
CH1	A11	Current input
	V11	Voltage input
	C1	CH1 common terminal of analog input
CH0	A0	CH0 temperature input
	B0	CH0 input common terminal
	C0	CH0 input common terminal

CH1	A1	CH1 temperature input
	B1	CH1 input common terminal
	C1	CH1 input common terminal
CH0	AO0	Current output
	VO0	Voltage output
	C0	CH0 common terminal of analog output
CH1	AO1	Current output
	VO1	Voltage output
	C1	CH1 common terminal of analog output
-	24V+	+24V power supply
	24V-	Power supply common terminal

18-3. The assignment of I/O address

XD series analog modules do not occupy I/O units; the converted data is directly transferred into PLC register.

Note: each channel can work after turning on the enable bit.

Register address of module 1:

AD Channel	AD signal	Channel enable bit
0CH	ID10000 (dword)	Y10000
1CH	ID10002 (dword)	Y10001
PT channel	PT signal	Channel enable bit
0CH	ID10004	Y10002
1CH	ID10005	Y10003
DA channel	DA signal	Channel enable bit
0CH	QD10000	Y10004
1CH	QD10001	Y10005

Register address of module 2:

AD Channel	AD signal	Channel enable bit
0CH	ID10100 (dword)	Y10100
1CH	ID10102 (dword)	Y10101
PT channel	PT signal	Channel enable bit
0CH	ID10104	Y10102
1CH	ID10105	Y10103
DA channel	DA signal	Channel enable bit
0CH	QD10100	Y10104
1CH	QD10101	Y10105

Register address of module 3:

AD channel	AD signal	Channel enable bit
0CH	ID10200 (dword)	Y10200
1CH	ID10202 (dword)	Y10201
PT channel	PT signal	Channel enable bit
0CH	ID10204	Y10202
1CH	ID10205	Y10203
DA channel	DA signal	Channel enable bit
0CH	QD10200	Y10204
1CH	QD10201	Y10205

Register address of module 4:

AD channel	AD signal	Channel enable bit
0CH	ID10300 (dword)	Y10300
1CH	ID10302 (dword)	Y10301
PT channel	PT signal	Channel enable bit
0CH	ID10304	Y10302
1CH	ID10305	Y10303
DA channel	DA signal	Channel enable bit
0CH	QD10300	Y10304
1CH	QD10301	Y10305

Register address of module 5:

AD channel	AD signal	Channel enable bit
0CH	ID10400 (dword)	Y10400
1CH	ID10402 (dword)	Y10401
PT channel	PT signal	Channel enable bit
0CH	ID10404	Y10402
1CH	ID10405	Y10403
DA channel	DA signal	Channel enable bit
0CH	QD10400	Y10404
1CH	QD10401	Y10405

Register address of module 6:

AD channel	AD signal	Channel enable bit
0CH	ID10500 (dword)	Y10500
1CH	ID10502 (dword)	Y10501
PT channel	PT signal	Channel enable bit
0CH	ID10504	Y10502
1CH	ID10505	Y10503
DA channel	DA signal	Channel enable bit
0CH	QD10500	Y10504
1CH	QD10501	Y10505

Register address of module 7:

AD channel	AD signal	Channel enable bit
0CH	ID10600 (dword)	Y10600
1CH	ID10602 (dword)	Y10601
PT channel	PT signal	Channel enable bit
0CH	ID10604	Y10602
1CH	ID10605	Y10603
DA channel	DA signal	Channel enable bit
0CH	QD10600	Y10604
1CH	QD10601	Y10605

Register address of module 8:

AD channel	AD signal	Channel enable bit
0CH	ID10700 (dword)	Y10700
1CH	ID10702 (dword)	Y10701
PT channel	PT signal	Channel enable bit
0CH	ID10704	Y10702
1CH	ID10705	Y10703
DA channel	DA signal	Channel enable bit
0CH	QD10700	Y10704
1CH	QD10701	Y10705

Register address of module 9:

AD channel	AD signal	Channel enable bit
0CH	ID11000 (dword)	Y11000
1CH	ID11002 (dword)	Y11001
PT channel	PT signal	Channel enable bit
0CH	ID11004	Y11002
1CH	ID11005	Y11003
DA channel	DA signal	Channel enable bit
0CH	QD11000	Y11004
1CH	QD11001	Y11005

Register address of module 10:

AD channel	AD signal	Channel enable bit
0CH	ID11100 (dword)	Y11100
1CH	ID11102 (dword)	Y11101
PT channel	PT signal	Channel enable bit
0CH	ID11104	Y11102
1CH	ID11105	Y11103
DA channel	DA signal	Channel enable bit
0CH	QD11100	Y11104
1CH	QD11101	Y11105

Register address of module 11:

AD channel	AD signal	Channel enable bit
0CH	ID11200 (dword)	Y11200
1CH	ID11202 (dword)	Y11201
PT channel	PT signal	Channel enable bit
0CH	ID11204	Y11202
1CH	ID11205	Y11203
DA channel	DA signal	Channel enable bit
0CH	QD11200	Y11204
1CH	QD11201	Y11205

Register address of module 12:

AD channel	AD signal	Channel enable bit
0CH	ID11300 (dword)	Y11300
1CH	ID11302 (dword)	Y11301
PT channel	PT signal	Channel enable bit
0CH	ID11304	Y11302
1CH	ID11305	Y11303
DA channel	DA signal	Channel enable bit
0CH	QD11300	Y11304
1CH	QD11301	Y11305

Register address of module 13:

AD channel	AD signal	Channel enable bit
0CH	ID11400 (dword)	Y11400
1CH	ID11402 (dword)	Y11401
PT channel	PT signal	Channel enable bit
0CH	ID11404	Y11402
1CH	ID11405	Y11403
DA channel	DA signal	Channel enable bit
0CH	QD11400	Y11404
1CH	QD11401	Y11405

Register address of module 14:

AD channel	AD signal	Channel enable bit
0CH	ID11500 (dword)	Y11500
1CH	ID11502 (dword)	Y11501
PT channel	PT signal	Channel enable bit
0CH	ID11504	Y11502
1CH	ID11505	Y11503
DA channel	DA signal	Channel enable bit
0CH	QD11500	Y11504

1CH	QD11501	Y11505
-----	---------	--------

Register address of module 15:

AD channel	AD signal	Channel enable bit
0CH	ID11600 (dword)	Y11600
1CH	ID11602 (dword)	Y11601
PT channel	PT signal	Channel enable bit
0CH	ID11604	Y11602
1CH	ID11605	Y11603
DA channel	DA signal	Channel enable bit
0CH	QD11600	Y11604
1CH	QD11601	Y11605

Register address of module 16:

AD channel	AD signal	Channel enable bit
0CH	ID11700 (dword)	Y11700
1CH	ID11702 (dword)	Y11701
PT channel	PT signal	Channel enable bit
0CH	ID11704	Y11702
1CH	ID11705	Y11703
DA channel	DA signal	Channel enable bit
0CH	QD11700	Y11704
1CH	QD11701	Y11705

Note:

1. Forbid the unused channel to improve the I/O scanning speed.
2. If turn off the enable bit of the input channel, this channel will not accept the data. (the data display is 0).
3. If turn off the enable bit of the output channel, this channel will keep the former data.

18-4. Working mode

There are two ways to set the working mode:

1. XDPpro software
2. Flash registers of PLC

XDPpro software:

Open the XDPpro software, click configure/expansion module settings.

Set the model and channel parameters in the following window. Then click write to PLC.

Please restart the PLC after setting.

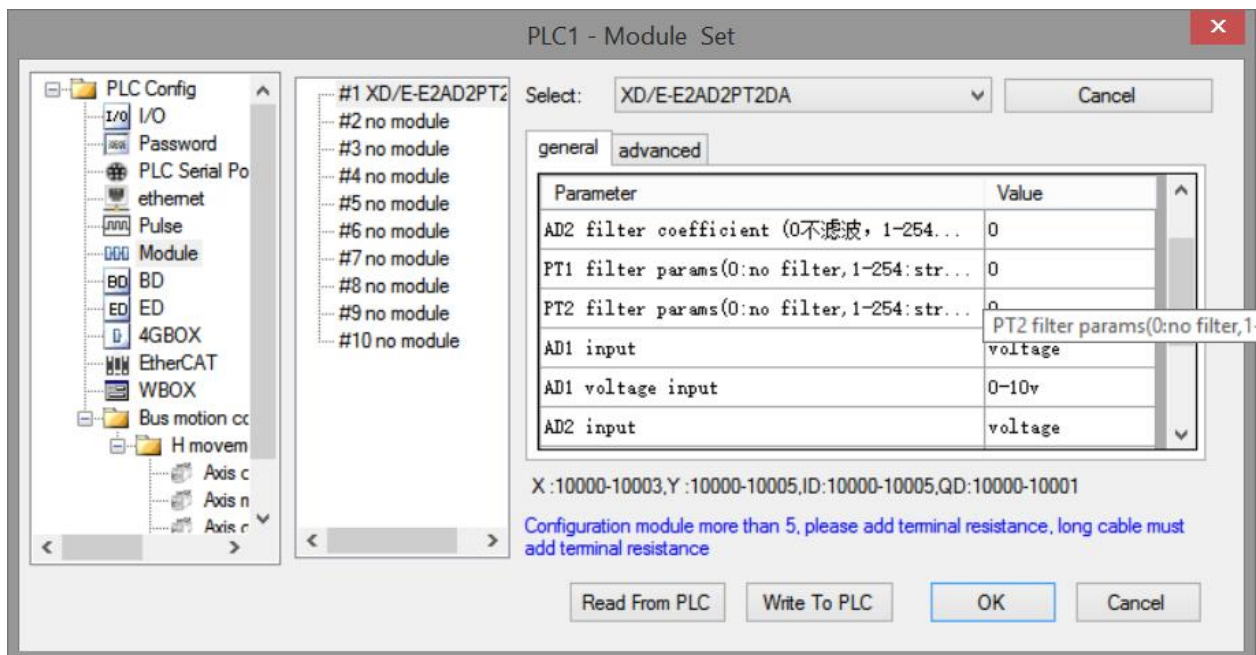

Note:

1. first-order low-pass filter will weight present sampling value with last time filter output to get the final filter value.
2. The filter parameter range is 0 to 254, the smaller the value is, the more stable the data is, but it may cause data lag; therefore, when it is set to 1, the filtering effect is the strongest and the data is the most stable; when it is set to 254, the filtering effect is the weakest and the default is 0 (no filtering).

Flash registers:

The module has current and voltage mode. Current has choices of 0~20mA, 4~20mA; voltage has choices of 0~5V, 0~10V. These parameters can be set through SFD registers.

Module no.	SFD address	Module no.	SFD address
#1	SFD350~SFD359	#9	SFD430~SFD439
#2	SFD360~SFD369	#10	SFD440~SFD449
#3	SFD370~SFD379	#11	SFD450~SFD459
#4	SFD380~SFD389	#12	SFD460~SFD469
#5	SFD390~SFD399	#13	SFD470~SFD479
#6	SFD400~SFD409	#14	SFD480~SFD489

#7	SFD410~SFD419	#15	SFD490~SFD499
#8	SFD420~SFD429	#16	SFD500~SFD509

Note: As shown in the preceding table, every register set 4 channels mode, each register has 16 bits, from low to high, every 4 bits set 1 channel mode.

SFD register bit definition:

Module no.1:

Register		Bit7	Bit6	Bit5	Bit4	Bit3	Bit2	Bit1	Bit0	Note	
SFD350	Byte0	AD channel 0 filter parameter								AD filter parameter	
	Byte1	AD channel 1 filter parameter									
SFD351	Byte2	PT channel 0 filter parameter								PT filter parameter	
	Byte3	PT channel 1 filter parameter									
SFD352	Byte4	Bit7	Bit6	Bit5	Bit4	Bit3	Bit2	Bit1	Bit0	It is used to specify the input range of AD and DA modules. The lower 4 bits of byte4 are the set bits of AD channel 1, and the higher 4 bits are the set bits of AD channel 2. The low 4 bits of byte5 are the setting bits of DA channel 1, and the high 4 bits are the setting bits of DA channel 2.	
		AD2				AD1					
		-	000: 0~10V 001: 0~5V 010: 0~20mA 011: 4~20mA				-	000: 0~10V 001: 0~5V 010: 0~20mA 011: 4~20mA			
	Byte5	Bit7	Bit6	Bit5	Bit4	Bit3	Bit2	Bit1	Bit0		
		DA2				DA1					
		-	000: 0~10V 001: 0~5V 010: 0~20mA 011: 4~20mA				-	000: 0~10V 001: 0~5V 010: 0~20mA 011: 4~20mA			
SFD353~SFD359		-									

For example:

Set the module no.1 AD channel 3, 2, 1, 0 working mode to 0~20mA, 4~20mA, 0~10V, 0~5V. Set the channel 1 and 2 filter factor to 254, set the channel 3 and 4 filter factor to 100. Set DA channel 1 and 0 working mode to 0~10V, 0~20mA.

So the SFD register values are:

SFD350=64FEH SFD351=4C1H SFD352=10H

18-5. Exterior connection

When make exterior connection, please read the following items:

- When connect +24V power, please choose 24V power of PLC to avoid interference.
- To avoid interference, please use shield cable and single point ground for the shield layer.

3-wire mode PT100 resistor input wiring diagram:

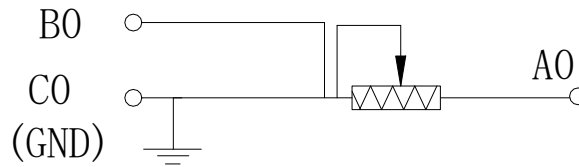

For the general three wire PT100 platinum thermistor, the wiring mode can be distinguished according to the wire color. The two wires of the same color can be randomly connected to terminal B0 and C0, and the other end can be connected to terminal A0.

Three wire thermocouple input

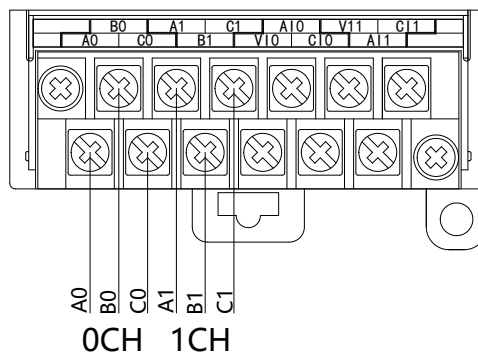

Voltage input

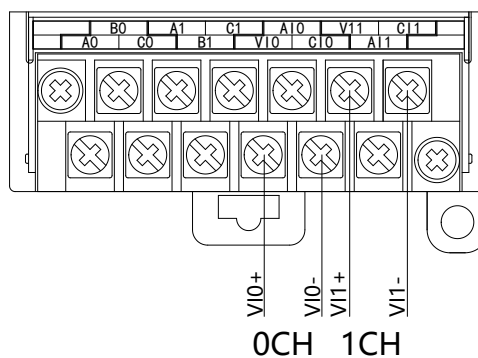

Current input

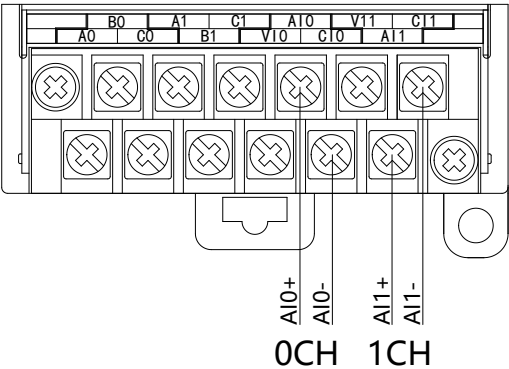

XD-E2AD2PT2DA current input wiring:

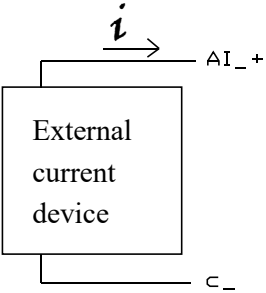

Voltage output

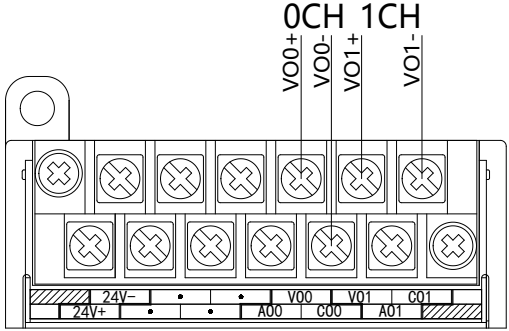

Current output

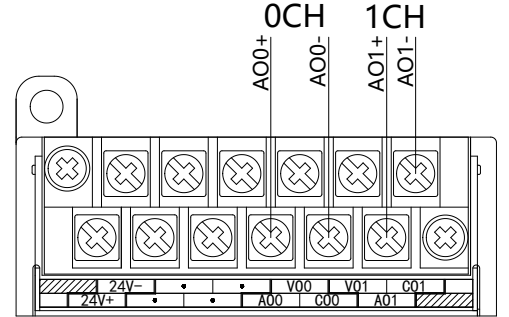

Note: the current output no needs to connect DC24V power supply.

18-6. AD conversion diagram

The relationship between analog input and corresponding digital value:

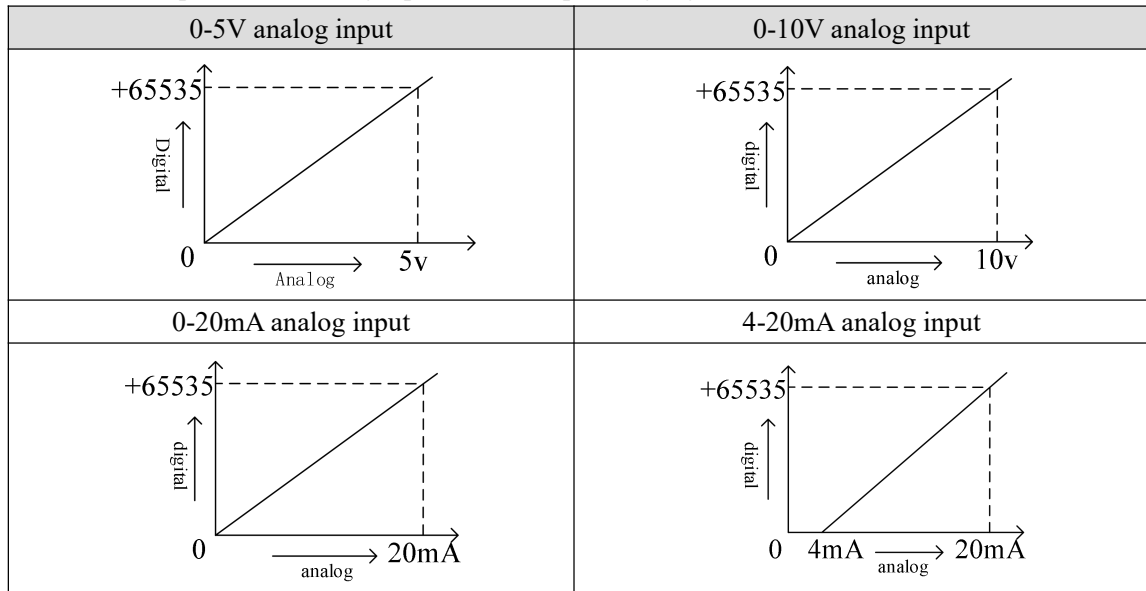

The relationship between input digital value and corresponding analog value:

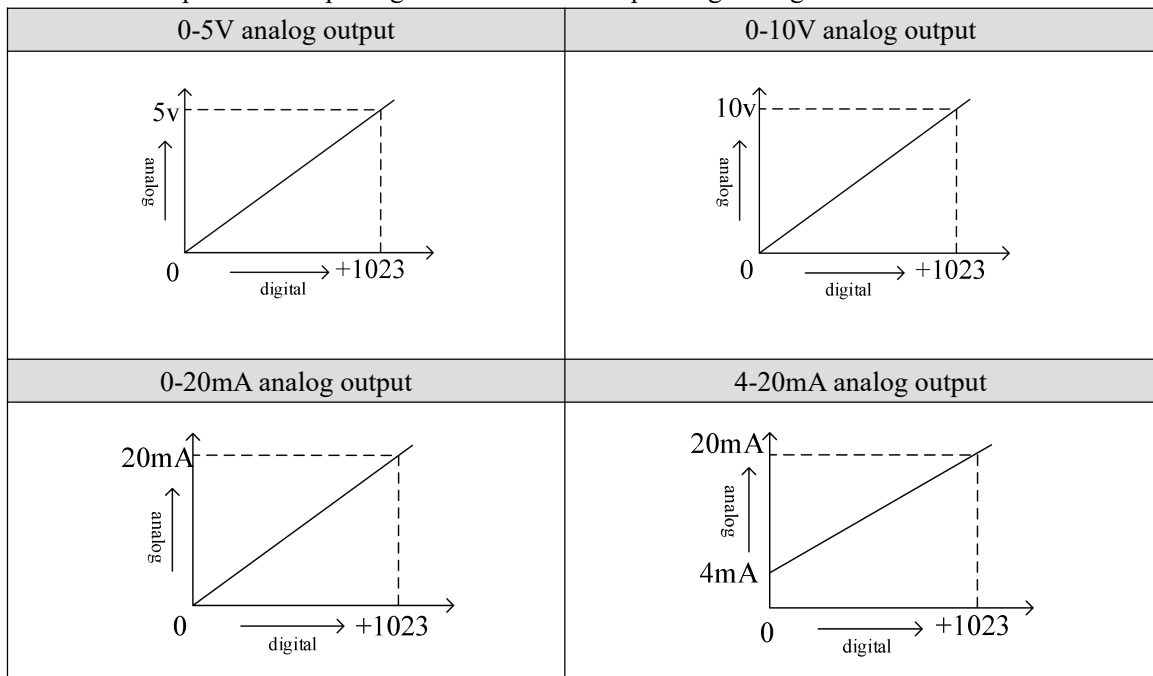

Note: When input data exceeds K1023, analog output will keep the value of 5V, 10V or 20mA.

18-7. Programming

Example:

The output signal of the existing pressure sensor needs to be collected (pressure sensor performance parameters: detection pressure range 0Mp ~ 10Mp, output analog signal 4 ~ 20mA), and one channel of 0V ~ 10V voltage signal needs to be output to the inverter.

Analysis: because the pressure detection range of the pressure sensor is 0Mp ~ 10Mp, the corresponding output analog quantity is 4 ~ 20mA, and the digital quantity range of the expansion module through analog-to-digital conversion is 0 ~ 65535; therefore, we can skip the analog quantity 4 ~ 20mA of the intermediate conversion link, which directly means that the pressure detection range is 0Mp ~ 10Mp, and the corresponding digital quantity range is 0 ~ 65535; $10\text{Mp} / 65536 = 0.0001525879$, the real-time pressure of the current pressure sensor is the real-time value collected in the ID register of the expansion module multiplied by 0.0001525879. For example, if the digital value collected in the ID register is 16384, the corresponding pressure is 2.5Mp.

Similarly, the range of digital value set in the register QD of the expansion module is 0 ~ 1023, which corresponds to the voltage output signal 0V ~ 10V, and $10\text{V} / 1024 = 0.0097656$, which indicates how much voltage value is output for each digital value set in the register QD of the expansion module. For example, 3V voltage value needs to be output now, $3\text{V} / 0.0024414 = 307$, and the calculated digital value is sent to the corresponding QD register.

Note: please use floating-point number for calculation, otherwise the calculation accuracy will be affected or even unable to calculate!

Program:

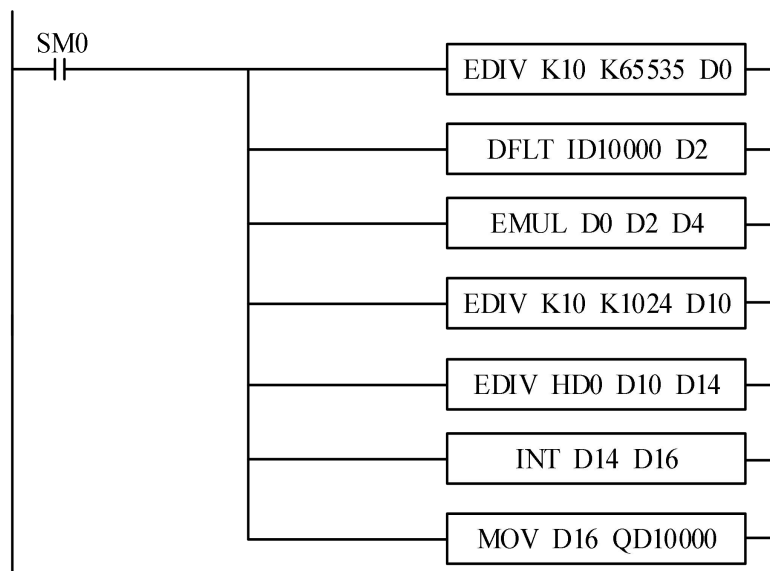

Explanation:

SM0 is normally on coil, which is always on during PLC operation.

When PLC starts to run, analog quantity acquisition first calculates the pressure value corresponding to each digit 1 of the digital quantity collected by the expansion module, and then converts the digital quantity (integer) collected in ID10000 register into floating-point number. So the real-time value collected in ID10000 register

of the expansion module is multiplied by the pressure value corresponding to each digit 1 of the digital quantity collected by the expansion module, it can be calculated the collected real-time pressure value.

Similarly, the analog output first calculates the voltage value corresponding to each digit 1 of the digital quantity collected by the expansion module, then divides the set target voltage value by it to get the set digital value (floating point number). Since QD10000 register can only store integers, it is necessary to convert the floating-point number to integer and send to QD10000.

Note: please turn on the enable bit of the used channel, that is, set Y10000 and Y1004 to on.

19. Analog extension module XD-E3AD4PT2DA

19-1. Specification

This chapter will introduce the XD-E3AD4PT2DA module specification, terminal and I/O assignment, working mode, external wiring, AD diagram and programming example.

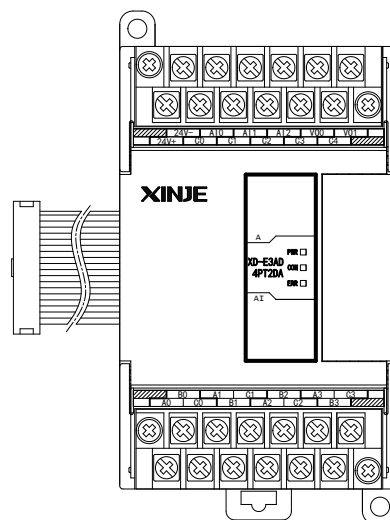

Features:

XD-E3AD4PT2DA analog expansion module converts three channels of analog input values into digital values, processes four channels of PT100 temperature signals, converts two channels of digital values into analog values, and transmits them to PLC main unit for real-time data interaction with PLC main unit.

- It has 3 channels of 14-bit precision analog input, 4-channel PT100 temperature input and 2-channel 10-bit precision analog output.
- 3-channel current 0 ~ 20mA, 4 ~ 20mA input and 2-channel voltage 0 ~ 5V, 0 ~ 10V output, set through the upper computer.
- As an extension module of XD series, XD3/XD3E series can connect up to 10 modules; XD5/XDM/XDC/XD5E/XDME/XDH series can connect up to 16 modules (not supported by XD1/XD2 series).

Specifications:

Item	Analog input (AD)	Temperature input (PT)	Analog output (DA)
	Current input (mA)		Voltage output (V)
Analog input range	0~20,4~20mA (impedance is about 120Ω)	-100~500°C	—
Max input range	-20~40mA	—	
Analog output range	—	—	0~5, 0~10V External load resistor 2KΩ~1MΩ
Digital input range	—	—	10-bit binary (0~1023)
Digital output range	14-bit binary (0~16383)	-1000~5000	—
Resolution	1/16383(14Bit)	0.1°C	1/1023(10Bit)
Integrated precision	±1%	±1% (relative max value)	±1%
Conversion speed	2ms per channel		2ms per channel
Module power supply	DC24V±10%, 150mA		

19-2. Terminals

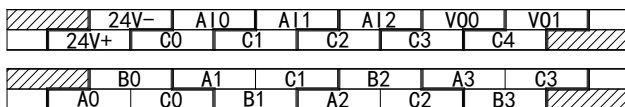

Channel	Terminal	Signal
CH0	AI0	0CH current input
	C0	0CH current input common terminal
CH1	AI1	1CH current input
	C1	1CH current input common terminal
CH2	AI2	2CH current input
	C2	2CH current input common terminal
CH0	A0	0CH temperature input
	B0	-
	C0	0CH input common terminal
CH1	A1	1CH temperature input
	B1	-
	C1	1CH input common terminal
CH2	A2	2CH temperature input

	B2	-
	C2	2CH input common terminal
CH3	A3	3CH temperature input
	B3	-
	C3	3CH input common terminal
CH0	VO0	0CH voltage output
	C3	0CH voltage output common terminal
CH1	VO1	1CH voltage output
	C4	1CH voltage output common terminal
-	24V	+24V power supply input
	0V	Power supply common terminal

19-3. The assignment of I/O address

XD series analog modules do not occupy I/O units; the converted data is directly transferred into PLC register.

Note: each channel can work after turning on the enable bit.

Register address of module 1:

AD channel	AD signal	Channel enable bit
0CH	ID10000	Y10000
1CH	ID10001	Y10001
2CH	ID10002	Y10002
PT channel	PT signal	Channel enable bit
0CH	ID10003	Y10003
1CH	ID10004	Y10004
2CH	ID10005	Y10005
3CH	ID10006	Y10006
DA channel	DA signal	Channel enable bit
0CH	QD10000	Y10007
1CH	QD10001	Y10010

Register address of module 2:

AD channel	AD signal	Channel enable bit
0CH	ID10100	Y10100
1CH	ID10101	Y10101
2CH	ID10102	Y10102
PT channel	PT signal	Channel enable bit
0CH	ID10103	Y10103
1CH	ID10104	Y10104
2CH	ID10105	Y10105
3CH	ID10106	Y10106
DA channel	DA signal	Channel enable bit

0CH	QD10100	Y10107
1CH	QD10101	Y10110

Register address of module 3:

AD channel	AD signal	Channel enable bit
0CH	ID10200	Y10200
1CH	ID10201	Y10201
2CH	ID10202	Y10202
PT channel	PT signal	Channel enable bit
0CH	ID10203	Y10203
1CH	ID10204	Y10204
2CH	ID10205	Y10205
3CH	ID10206	Y10206
DA channel	DA signal	Channel enable bit
0CH	QD10200	Y10207
1CH	QD10201	Y10210

Register address of module 4:

AD channel	AD signal	Channel enable bit
0CH	ID10300	Y10300
1CH	ID10301	Y10301
2CH	ID10302	Y10302
PT channel	PT signal	Channel enable bit
0CH	ID10303	Y10303
1CH	ID10304	Y10304
2CH	ID10305	Y10305
3CH	ID10306	Y10306
DA channel	DA signal	Channel enable bit
0CH	QD10300	Y10307
1CH	QD10301	Y10310

Register address of module 5:

AD channel	AD signal	Channel enable bit
0CH	ID10400	Y10400
1CH	ID10401	Y10401
2CH	ID10402	Y10402
PT channel	PT signal	Channel enable bit
0CH	ID10403	Y10403
1CH	ID10404	Y10404
2CH	ID10405	Y10405
3CH	ID10406	Y10406
DA channel	DA signal	Channel enable bit
0CH	QD10400	Y10407

1CH	QD10401	Y10410
-----	---------	--------

Register address of module 6:

AD channel	AD signal	Channel enable bit
0CH	ID10500	Y10500
0CH	ID10501	Y10501
2CH	ID10502	Y10502
PT channel	PT signal	Channel enable bit
0CH	ID10503	Y10503
1CH	ID10504	Y10504
2CH	ID10505	Y10505
3CH	ID10506	Y10506
DA channel	DA signal	Channel enable bit
0CH	QD10500	Y10507
1CH	QD10501	Y10510

Register address of module 7:

AD channel	AD signal	Channel enable bit
0CH	ID10600	Y10600
1CH	ID10601	Y10601
2CH	ID10602	Y10602
PT channel	PT signal	Channel enable bit
0CH	ID10603	Y10603
1CH	ID10604	Y10604
2CH	ID10605	Y10605
3CH	ID10606	Y10606
DA channel	DA signal	Channel enable bit
0CH	QD10600	Y10607
1CH	QD10601	Y10610

Register address of module 8:

AD channel	AD signal	Channel enable bit
0CH	ID10700	Y10700
1CH	ID10701	Y10701
2CH	ID10702	Y10702
PT channel	PT signal	Channel enable bit
0CH	ID10703	Y10703
1CH	ID10704	Y10704
2CH	ID10705	Y10705
3CH	ID10706	Y10706
DA channel	DA signal	Channel enable bit
0CH	QD10700	Y10707

1CH	QD10701	Y10710
-----	---------	--------

Register address of module 9:

AD channel	AD signal	Channel enable bit
0CH	ID11000	Y11000
1CH	ID11001	Y11001
2CH	ID11002	Y11002
PT channel	PT signal	Channel enable bit
0CH	ID11003	Y11003
1CH	ID11004	Y11004
2CH	ID11005	Y11005
3CH	ID11006	Y11006
DA channel	DA signal	Channel enable bit
0CH	QD11000	Y11007
1CH	QD11001	Y11010

Register address of module 10:

AD channel	AD signal	Channel enable bit
0CH	ID11100	Y11100
1CH	ID11101	Y11101
2CH	ID11102	Y11102
PT channel	PT signal	Channel enable bit
0CH	ID11103	Y11103
1CH	ID11104	Y11104
2CH	ID11105	Y11105
3CH	ID11106	Y11106
DA channel	DA signal	Channel enable bit
0CH	QD11100	Y11107
1CH	QD11101	Y11110

Register address of module 11:

AD channel	AD signal	Channel enable bit
0CH	ID11200	Y11200
1CH	ID11201	Y11201
2CH	ID11202	Y11202
PT channel	PT signal	Channel enable bit
0CH	ID11203	Y11203
1CH	ID11204	Y11204
2CH	ID11205	Y11205
3CH	ID11206	Y11206
DA channel	DA signal	Channel enable bit
0CH	QD11200	Y11207
1CH	QD11201	Y11210

Register address of module 12:

AD channel	AD signal	Channel enable bit
0CH	ID11300	Y11300
1CH	ID11301	Y11301
2CH	ID11302	Y11302
PT channel	PT signal	Channel enable bit
0CH	ID11303	Y11303
1CH	ID11304	Y11304
2CH	ID11305	Y11305
3CH	ID11306	Y11306
DA channel	DA signal	Channel enable bit
0CH	QD11300	Y11307
1CH	QD11301	Y11310

Register address of module 13:

AD channel	AD signal	Channel enable bit
0CH	ID11400	Y11400
1CH	ID11401	Y11401
2CH	ID11402	Y11402
PT channel	PT signal	Channel enable bit
0CH	ID11403	Y11403
1CH	ID11404	Y11404
2CH	ID11405	Y11405
3CH	ID11406	Y11406
DA channel	DA signal	Channel enable bit
0CH	QD11400	Y11407
1CH	QD11401	Y11410

Register address of module 14:

AD channel	AD signal	Channel enable bit
0CH	ID11500	Y11500
1CH	ID11501	Y11501
2CH	ID11502	Y11502
PT channel	PT signal	Channel enable bit
0CH	ID11503	Y11503
1CH	ID11504	Y11504
2CH	ID11505	Y11505
3CH	ID11506	Y11506
DA channel	DA signal	Channel enable bit
0CH	QD11500	Y11507
1CH	QD11501	Y11510

Register address of module 15:

AD channel	AD signal	Channel enable bit
0CH	ID11600	Y11600
1CH	ID11601	Y11601
2CH	ID11602	Y11602
PT channel	PT signal	Channel enable bit
0CH	ID11603	Y11603
1CH	ID11604	Y11604
2CH	ID11605	Y11605
3CH	ID11606	Y11606
DA channel	DA signal	Channel enable bit
0CH	QD11600	Y11607
1CH	QD11601	Y11610

Register address of module 16:

AD channel	AD signal	Channel enable bit
0CH	ID11700	Y11700
1CH	ID11701	Y11701
2CH	ID11702	Y11702
PT channel	PT signal	Channel enable bit
0CH	ID11703	Y11703
1CH	ID11704	Y11704
2CH	ID11705	Y11705
3CH	ID11706	Y11706
DA channel	DA signal	Channel enable bit
0CH	QD11700	Y11707
1CH	QD11701	Y11710

Note:

1. Forbid the unused channel to improve the I/O scanning speed.
2. If turn off the enable bit of the input channel, this channel will not accept the data. (the data display is 0).
3. If turn off the enable bit of the output channel, this channel will keep the former data.

19-4. Working mode

There are two ways to set the working mode:

1. XDPpro software
2. Flash registers of PLC

XDPpro software:

Open the XDPpro software, click configure/expansion module settings.

Set the model and channel parameters in the following window. Then click write to PLC.

Please restart the PLC after setting.

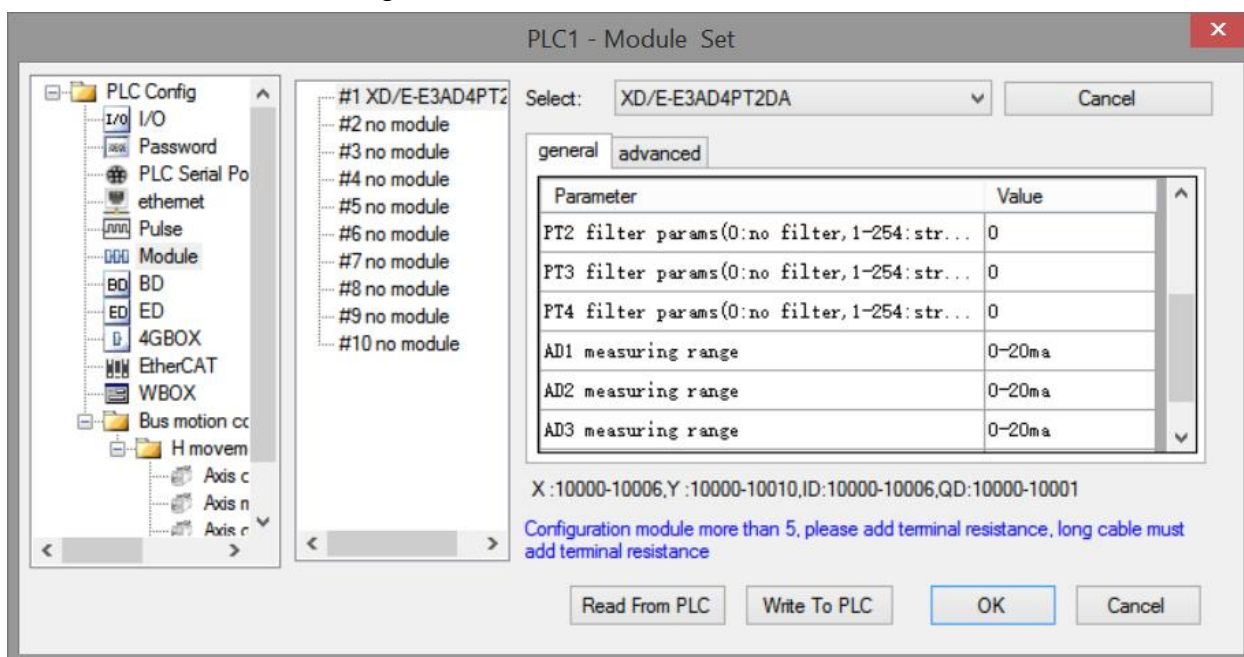

Note:

1. first-order low-pass filter will weight present sampling value with last time filter output to get the final filter value.
2. The filter parameter range is 0 to 254, the smaller the value is, the more stable the data is, but it may cause data lag; therefore, when it is set to 1, the filtering effect is the strongest and the data is the most stable; when it is set to 254, the filtering effect is the weakest and the default is 0 (no filtering).

Flash registers:

The input channel of expansion module is current mode, and the current is 0-20mA and 4-20mA, and the output channel is voltage mode, and the voltage is 0-5V and 0-10V. It is set by special flash data register SFD in PLC. As follows:

Module no.	SFD address	Module no.	SFD address
#1	SFD350~SFD359	#9	SFD430~SFD439
#2	SFD360~SFD369	#10	SFD440~SFD449
#3	SFD370~SFD379	#11	SFD450~SFD459
#4	SFD380~SFD389	#12	SFD460~SFD469
#5	SFD390~SFD399	#13	SFD470~SFD479

#6	SFD400~SFD409	#14	SFD480~SFD489
#7	SFD410~SFD419	#15	SFD490~SFD499
#8	SFD420~SFD429	#16	SFD500~SFD509

Note: As shown in the preceding table, every register set 4 channels mode, each register has 16 bits, from low to high, every 4 bits set 1 channel mode.

SFD register bit definition:

Module no.1:

Register		Bit7	Bit6	Bit5	Bit4	Bit3	Bit2	Bit1	Bit0	Note
SFD350	Byte0	AD channel 0 filter parameter								AD filter parameter
	Byte1	AD channel 1 filter parameter								
SFD351	Byte2	AD channel 2 filter parameter								
	Byte3	PT channel 0 filter parameter								PT filter parameter
SFD352	Byte4	PT channel 1 filter parameter								
	Byte5	PT channel 2 filter parameter								
SFD353	Byte6	PT channel 3 filter parameter								Used to specify the input range of AD and DA modules, byte7 low 4-bit is the setting bit of AD channel 1, and the high 4-bit is the setting bit of AD channel 2. Byte8 low 4 bits are set for AD channel 3, and the high 4 bits are DA channel 1. The lower 4 bits of byte9 are the setting bits of DA channel 2, and the high 4 bits are reserved.
	Byte7	Bit7	Bit6	Bit5	Bit4	Bit3	Bit2	Bit1	Bit0	
		AD2				AD1				
SFD354	Byte8	-	010: 0~20mA 011: 4~20mA			-	010: 0~20mA 011: 4~20mA			
		DA1				AD3				
		-	000: 0~10V 001: 0~5V			-	010: 0~20mA 011: 4~20mA			
	Byte9	Bit7	Bit6	Bit5	Bit4	Bit3	Bit2	Bit1	Bit0	
		DA2								
-	-				-	000: 0~10V 001: 0~5V				
SFD355~SFD359		-								

For example:

Set the module no.1 input channel 3, 2, 1, 0 working mode to 0~20mA, 4~20mA, 0~10V, 0~5V. Set the channel 1 and 2 filter factor to 254, set the channel 3 and 4 filter factor to 100. Set DA channel 1 and 0 working mode to 0~10V, 0~20mA.

So the SFD register values are:

SFD350=64FEH SFD351=4C1H SFD352=10H

19-5. Exterior connection

When make exterior connection, please read the following items:

- When connect +24V power, please choose 24V power of PLC to avoid interference.
- To avoid interference, please use shield cable and single point ground for the shield layer.

2-wire mode PT100 resistor input wiring diagram:

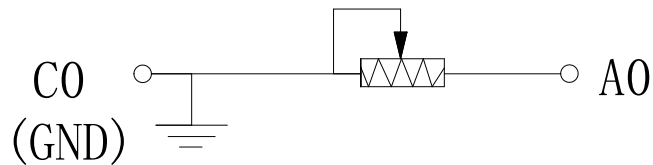

Note: the temperature input only supports two wire mode PT100 resistor input.

Two wire thermocouple input

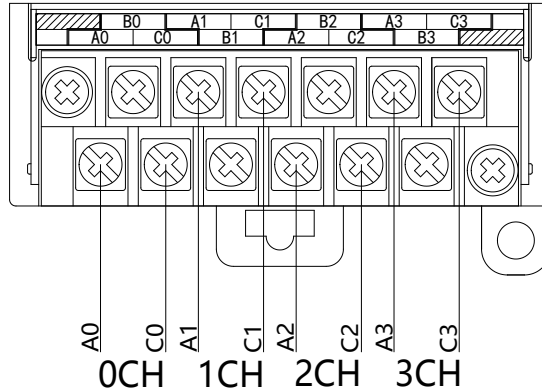

Current input

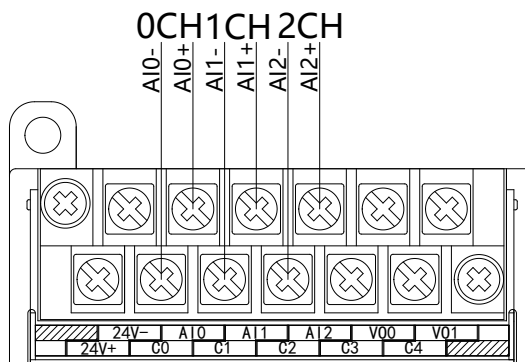

XD-E3AD4PT2DA current input wiring:

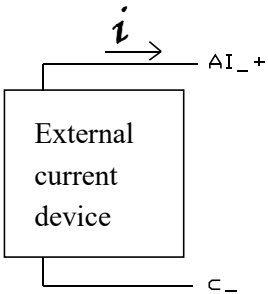

Voltage output

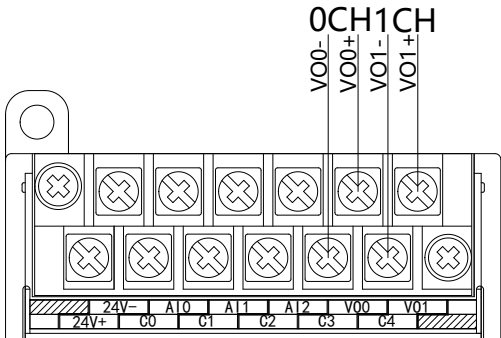

19-6. AD conversion diagram

The relationship between analog input and corresponding digital value:

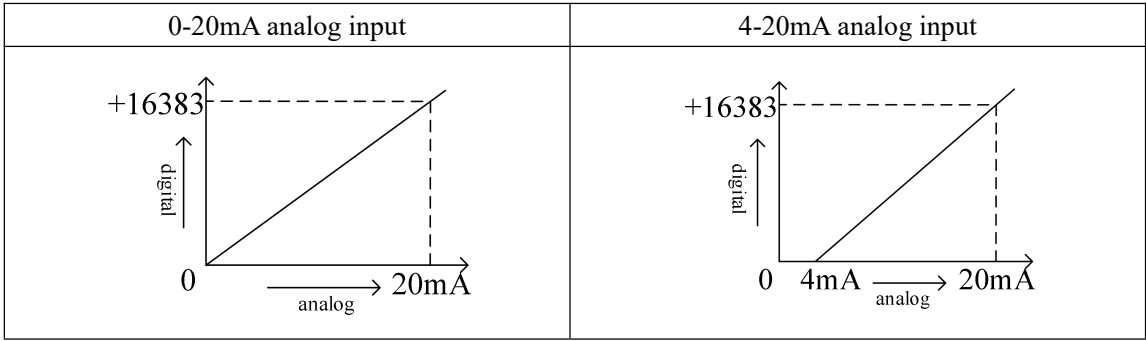

The relationship between input digital value and corresponding analog value:

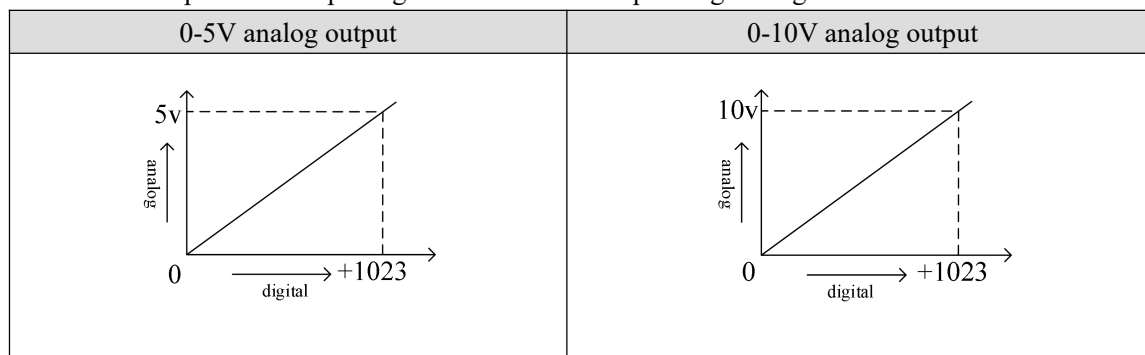

Note: When input data exceeds K1023, analog output will keep the value of 5V, 10V or 20mA.

19-7. Programming

Example:

The output signal of the existing pressure sensor needs to be collected (pressure sensor performance parameters: detection pressure range 0Mp ~ 10Mp, output analog signal 4 ~ 20mA), and one channel of 0V ~ 10V voltage signal needs to be output to the inverter.

Analysis: because the pressure detection range of the pressure sensor is 0Mp ~ 10Mp, the corresponding output analog quantity is 4 ~ 20mA, and the digital quantity range of the expansion module through analog-to-digital conversion is 0 ~ 16383; therefore, we can skip the analog quantity 4 ~ 20mA of the intermediate conversion link, which directly means that the pressure detection range is 0Mp ~ 10Mp, and the corresponding digital quantity range is 0 ~ 16383; $10\text{Mp} / 16384 = 0.0006103515$, the real-time pressure of the current pressure sensor is the real-time value collected in the ID register of the expansion module multiplied by 0.0006103515. For example, if the digital value collected in the ID register is 4096, the corresponding pressure is 2.5Mp.

Similarly, the range of digital value set in the register QD of the expansion module is 0 ~ 1023, which corresponds to the voltage output signal 0V ~ 10V, and $10\text{V} / 1024 = 0.0097656$, which indicates how much voltage value is output for each digital value set in the register QD of the expansion module. For example, 3V voltage value needs to be output now, $3\text{V} / 0.0097656 = 307$, and the calculated digital value is sent to the corresponding QD register.

Note: please use floating-point number for calculation, otherwise the calculation accuracy will be affected or even unable to calculate!

Program:

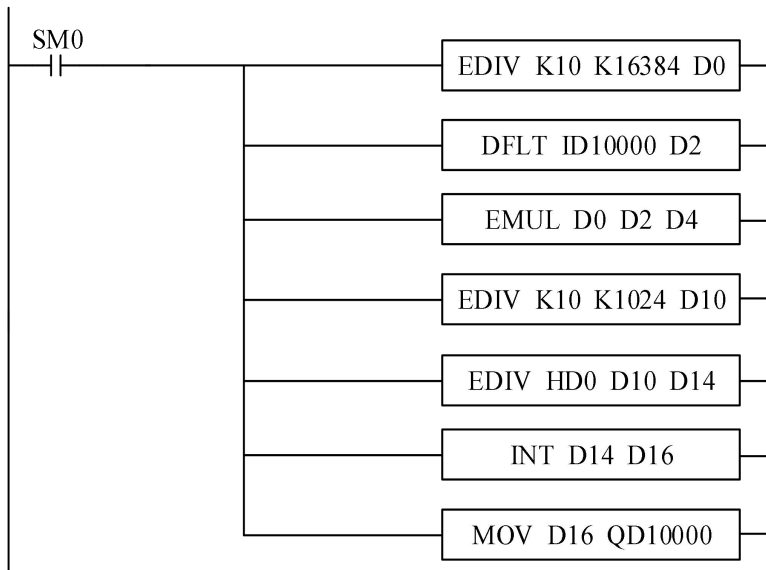

Explanation:

SM0 is normally on coil, which is always on during PLC operation.

When PLC starts to run, analog quantity acquisition first calculates the pressure value corresponding to each digit 1 of the digital quantity collected by the expansion module, and then converts the digital quantity (integer) collected in ID10000 register into floating-point number. So the real-time value collected in ID10000 register of the expansion module is multiplied by the pressure value corresponding to each digit 1 of the digital quantity collected by the expansion module, it can be calculated the collected real-time pressure value.

Similarly, the analog output first calculates the voltage value corresponding to each digit 1 of the digital quantity collected by the expansion module, then divides the set target voltage value by it to get the set digital value (floating point number). Since QD10000 register can only store integers, it is necessary to convert the floating-point number to integer and send to QD10000.

Note: please turn on the enable bit of the used channel, that is, set Y10000 and Y1007 to on.

20. X-NET relay module JR-EH

20-1. Suitable condition

JR-EH is X-NET relay module which fit for RS485 communication. The signal will be affected and bit error rate will rise when system baud rate is high, and there are many nodes or the distance is long. This module is recommended to improve the communication quality.

20-2. Features

Item	Parameter
Power supply	DC24V \pm 10%
Temperature/humidity	-15~65°C, 5%~95% no condensation
Standard	Accords to IEC-61000-4-2, IEC61000-4-4, IEC61000-4-5
Max load numbers	32
Baud rate	9600bps~3Mbps

20-3. Appearance

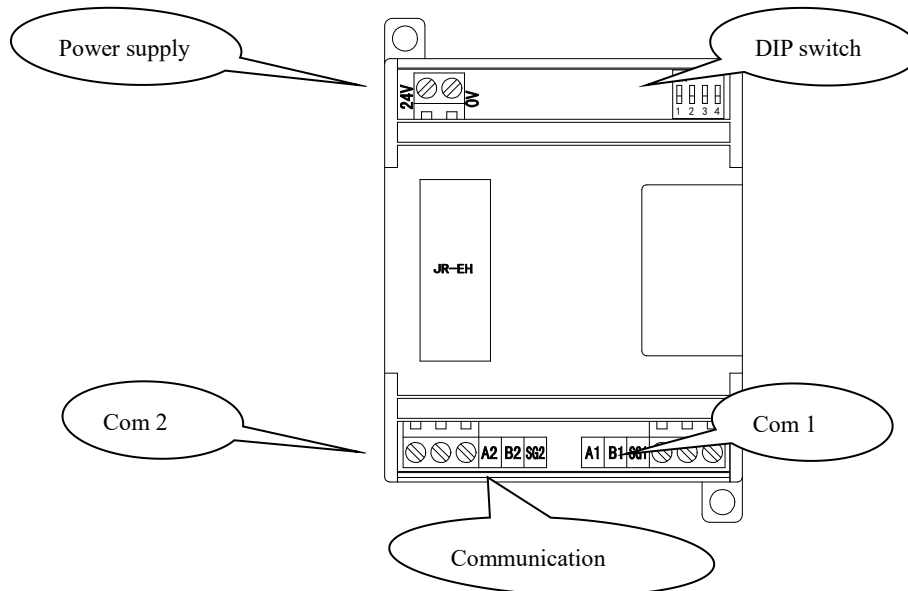

Com1 and com2 has no master and slave, they can be wiring as needs. Terminal A, B is for RS485, SG is ground terminal.

20-4. Baud rate

DIP switch	Baud rate	DIP switch	Baud rate
0000	Self-adaption	1000	256K
0001	9.6K	1001	288K
0010	19.2K	1010	384K
0011	28.8K	1011	512K
0100	38.4K	1100	576K
0101	57.6K	1101	768K
0110	115.2K	1110	1M
0111	192K	1111	3M

The two devices communicate with the same baud rate when the module is in self-adaption mode, the relay will lock the baud rate in 1 second and transfer the data. If the device communication has error, the relay will fail to lock the baud rate. We suggest user to choose fixed baud rate, user can use self-adaption mode if the baud rate is not listed in the above table.

20-5. LED

When the module is in self-adaption mode, LED always ON means the baud rate has been locked, LED OFF means it has not been locked.

When the module is in fixed baud rate state, LED flickering means the communication is normal, LED always ON means the communication has error.

20-6. Wiring diagram

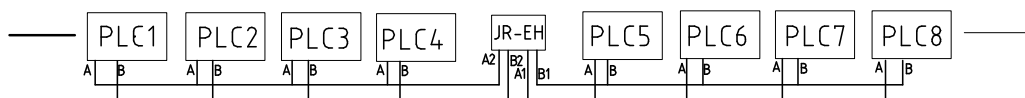

Please use the shielded twisted pair accords to EIA-485, resistor is 120ohm.

The relationship between baud rate and communication distance

Baud rate	Max distance
9.6-187.5Kbit/s	1000m
500Kbit/s	400m
1.5Mbit/s	200m
3Mbit/s	100m

20-7. Module naming rule

J	R	-	E	H
^	^		^	^
Module type	Repeater		RS485	High speed

20-8. Dimension

Unit:mm

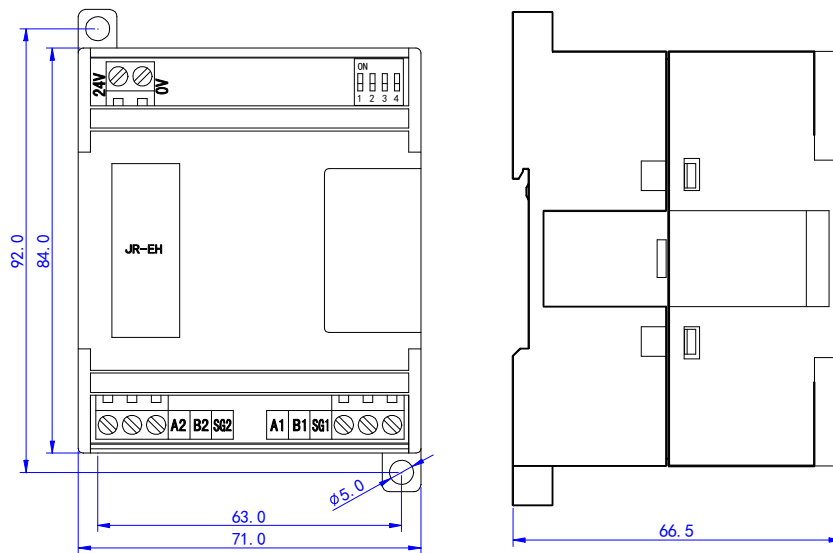

21. Analog input module XD-E12AD-V

21-1. Specification

XD-E12AD-V transform the analog value (voltage input) to digital value and send to PLC registers.

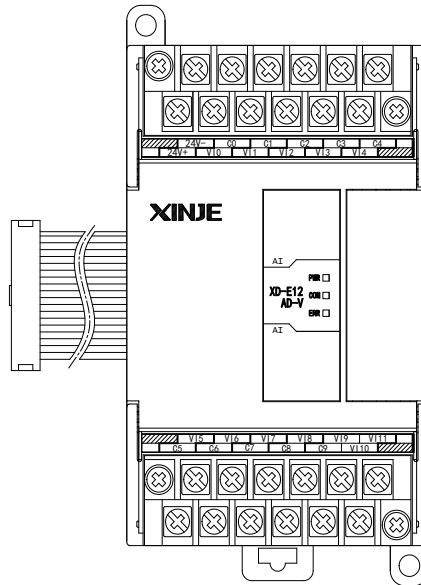

Features:

- 12-channel analog input: voltage input.
- 14-bit high precision analog input.
- As a special function module of XD series, XD3/XD3E can connect up to 10 modules on the right side of PLC main unit, XD5/XDM/XDC/XD5E/XDME/XDH can expand 16 modules, XD1/XD2 does not support expansion modules.

Specifications:

Items	Voltage input
Analog input range	0~5V, 0~10V, -10~10V, -5~5V (impedance > 1M)
Max input range	DC ± 15V
Digital output range	14 bits binary data (0~16383 or -8192~8191)
Resolution	1/16383 (14Bit)
Integrate Precision	± 1%
Conversion speed	4ms all the channels
Analog power supply	DC24V±10%, 150mA
Installation	Can be fixed with screw M3 or directly installed on orbit of DIN46277 (width: 35mm)
Dimension	63mm×108mm×89.9mm

21-2. Terminals

	24V-	C0	C1	C2	C3	C4	
	24V+	VI0	VI1	VI2	VI3	VI4	
	VI5	VI6	VI7	VI8	VI9	VI11	
	C5	C6	C7	C8	C9	VI10	

Channel	Terminal name	Signal name
CH0	VI0	voltage input
	C0	CH0 analog input common terminal
CH1	VI1	voltage input
	C1	CH1 analog input common terminal
CH2	VI2	voltage input
	C2	CH2 analog input common terminal
CH3	VI3	voltage input
	C3	CH3 analog input common terminal
CH4	VI4	voltage input
	C4	CH4 analog input common terminal
CH5	VI5	voltage input
	C5	CH5 analog input common terminal
CH6	VI6	voltage input
	C6	CH6 analog input common terminal
CH7	VI7	voltage input
	C7	CH7 analog input common terminal
CH8	VI8	voltage input
	C8	CH8 analog input common terminal
CH9~CH11	VI9	voltage input
	VI10	voltage input
	VI11	voltage input
	C9	CH9~CH11 analog input common terminal
-	24V+	+24V power supply
	24V-	Common terminal of power supply

21-3. I/O distribution

XD series analog expansion modules don't occupy I/O unit; the converted data is directly transferred to PLC register. Each channel address:

Note: each channel can only be used when the enable bit is turned on.

I/O address list

Register address of expansion module 1:

Channel	AD signal	Channel enable bit
0CH	ID10000	Y10000
1CH	ID10001	Y10001
2CH	ID10002	Y10002
3CH	ID10003	Y10003
4CH	ID10004	Y10004
5CH	ID10005	Y10005
6CH	ID10006	Y10006
7CH	ID10007	Y10007
8CH	ID10008	Y10010
9CH	ID10009	Y10011
10CH	ID10010	Y10012
11CH	ID10011	Y10013

Register address of expansion module 2:

Channel	AD signal	Channel enable bit
0CH	ID10100	Y10100
1CH	ID10101	Y10101
2CH	ID10102	Y10102
3CH	ID10103	Y10103
4CH	ID10104	Y10104
5CH	ID10105	Y10105
6CH	ID10106	Y10106
7CH	ID10107	Y10107
8CH	ID10108	Y10110
9CH	ID10109	Y10111
10CH	ID10110	Y10112
11CH	ID10111	Y10113

Register address of expansion module 3:

Channel	AD signal	Channel enable bit
0CH	ID10200	Y10200
1CH	ID10201	Y10201
2CH	ID10202	Y10202
3CH	ID10203	Y10203
4CH	ID10204	Y10204
5CH	ID10205	Y10205
6CH	ID10206	Y10206
7CH	ID10207	Y10207
8CH	ID10208	Y10210
9CH	ID10209	Y10211
10CH	ID10210	Y10212
11CH	ID10211	Y10213

Register address of expansion module 4:

Channel	AD signal	Channel enable bit
0CH	ID10300	Y10300
1CH	ID10301	Y10301
2CH	ID10302	Y10302
3CH	ID10303	Y10303
4CH	ID10304	Y10304
5CH	ID10305	Y10305
6CH	ID10306	Y10306
7CH	ID10307	Y10307
8CH	ID10308	Y10310
9CH	ID10309	Y10311
10CH	ID10310	Y10312
11CH	ID10311	Y10313

Register address of expansion module 5:

Channel	AD signal	Channel enable bit
0CH	ID10400	Y10400
1CH	ID10401	Y10401
2CH	ID10402	Y10402
3CH	ID10403	Y10403
4CH	ID10404	Y10404
5CH	ID10405	Y10405
6CH	ID10406	Y10406
7CH	ID10407	Y10407
8CH	ID10408	Y10410
9CH	ID10409	Y10411
10CH	ID10410	Y10412

Channel	AD signal	Channel enable bit
11CH	ID10411	Y10413

Register address of expansion module 6:

Channel	AD signal	Channel enable bit
0CH	ID10500	Y10500
1CH	ID10501	Y10501
2CH	ID10502	Y10502
3CH	ID10503	Y10503
4CH	ID10504	Y10504
5CH	ID10505	Y10505
6CH	ID10506	Y10506
7CH	ID10507	Y10507
8CH	ID10508	Y10510
9CH	ID10509	Y10511
10CH	ID10510	Y10512
11CH	ID10511	Y10513

Register address of expansion module 7:

Channel	AD signal	Channel enable bit
0CH	ID10600	Y10600
1CH	ID10601	Y10601
2CH	ID10602	Y10602
3CH	ID10603	Y10603
4CH	ID10604	Y10604
5CH	ID10605	Y10605
6CH	ID10606	Y10606
7CH	ID10607	Y10607
8CH	ID10608	Y10610
9CH	ID10609	Y10611
10CH	ID10610	Y10612
11CH	ID10611	Y10613

Register address of expansion module 8:

Channel	AD signal	Channel enable bit
0CH	ID10700	Y10700
1CH	ID10701	Y10701
2CH	ID10702	Y10702
3CH	ID10703	Y10703
4CH	ID10704	Y10704
5CH	ID10705	Y10705
6CH	ID10706	Y10706
7CH	ID10707	Y10707

8CH	ID10708	Y10710
9CH	ID10709	Y10711
10CH	ID10710	Y10712
11CH	ID10711	Y10713

Register address of expansion module 9:

Channel	AD signal	Channel enable bit
0CH	ID10800	Y11000
1CH	ID10801	Y11001
2CH	ID10802	Y11002
3CH	ID10803	Y11003
4CH	ID10804	Y11004
5CH	ID10805	Y11005
6CH	ID10806	Y11006
7CH	ID10807	Y11007
8CH	ID10808	Y11010
9CH	ID10809	Y11011
10CH	ID10810	Y11012
11CH	ID10811	Y11013

Register address of expansion module 10:

Channel	AD signal	Channel enable bit
0CH	ID10900	Y11100
1CH	ID10901	Y11101
2CH	ID10902	Y11102
3CH	ID10903	Y11103
4CH	ID10904	Y11104
5CH	ID10905	Y11105
6CH	ID10906	Y11106
7CH	ID10907	Y11107
8CH	ID10908	Y11110
9CH	ID10909	Y11111
10CH	ID10910	Y11112
11CH	ID10911	Y11113

Register address of expansion module 11:

Channel	AD signal	Channel enable bit
0CH	ID11000	Y11200
1CH	ID11001	Y11201
2CH	ID11002	Y11202
3CH	ID11003	Y11203
4CH	ID11004	Y11204
5CH	ID11005	Y11205
6CH	ID11006	Y11206
7CH	ID11007	Y11207
8CH	ID11008	Y11210
9CH	ID11009	Y11211
10CH	ID11010	Y11212
11CH	ID11011	Y11213

Register address of expansion module 12:

Channel	AD signal	Channel enable bit
0CH	ID11100	Y11300
1CH	ID11101	Y11301
2CH	ID11102	Y11302
3CH	ID11103	Y11303
4CH	ID11104	Y11304
5CH	ID11105	Y11305
6CH	ID11106	Y11306
7CH	ID11107	Y11307
8CH	ID11108	Y11310
9CH	ID11109	Y11311
10CH	ID11110	Y11312
11CH	ID11111	Y11313

Register address of expansion module 13:

Channel	AD signal	Channel enable bit
0CH	ID11200	Y11400
1CH	ID11201	Y11401
2CH	ID11202	Y11402
3CH	ID11203	Y11403
4CH	ID11204	Y11404
5CH	ID11205	Y11405
6CH	ID11206	Y11406
7CH	ID11207	Y11407
8CH	ID11208	Y11410
9CH	ID11209	Y11411
10CH	ID11210	Y11412

Channel	AD signal	Channel enable bit
11CH	ID11211	Y11413

Register address of expansion module 14:

Channel	AD signal	Channel enable bit
0CH	ID11300	Y11500
1CH	ID11301	Y11501
2CH	ID11302	Y11502
3CH	ID11303	Y11503
4CH	ID11304	Y11504
5CH	ID11305	Y11505
6CH	ID11306	Y11506
7CH	ID11307	Y11507
8CH	ID11308	Y11510
9CH	ID11309	Y11511
10CH	ID11310	Y11512
11CH	ID11311	Y11513

Register address of expansion module 15:

Channel	AD signal	Channel enable bit
0CH	ID11400	Y11600
1CH	ID11401	Y11601
2CH	ID11402	Y11602
3CH	ID11403	Y11603
4CH	ID11404	Y11604
5CH	ID11405	Y11605
6CH	ID11406	Y11606
7CH	ID11407	Y11607
8CH	ID11408	Y11610
9CH	ID11409	Y11611
10CH	ID11410	Y11612
11CH	ID11411	Y11613

Register address of expansion module 16:

Channel	AD signal	Channel enable bit
0CH	ID11500	Y11700
1CH	ID11501	Y11701
2CH	ID11502	Y11702
3CH	ID11503	Y11703
4CH	ID11504	Y11704
5CH	ID11505	Y11705
6CH	ID11506	Y11706
7CH	ID11507	Y11707

8CH	ID11508	Y11710
9CH	ID11509	Y11711
10CH	ID11510	Y11712
11CH	ID11511	Y11713

Note: If set off the enable bit of the channel, this channel will not accept the data. (the data display is 0).

21-4. Working mode

There are two ways to set the working mode:

3. XDPpro software
4. Flash registers of PLC

XDPpro software:

Open the XDPpro software, click configure/expansion module settings:

Set the model and channel parameters in the following window. Then click write to PLC.

Please restart the PLC after setting.

Note:

1. The first-order low-pass filtering method uses this sampling value and the last filtering output value for weighting to get the effective filtering value.
2. The filter coefficient is set to 0 ~ 254 by the user, the smaller the value is, the more stable the data is, but it may cause data lag; when it is set to 1, the filtering effect is the strongest, and when it is set to 254, the filtering effect is the weakest, and the default value is 0 (no filtering).

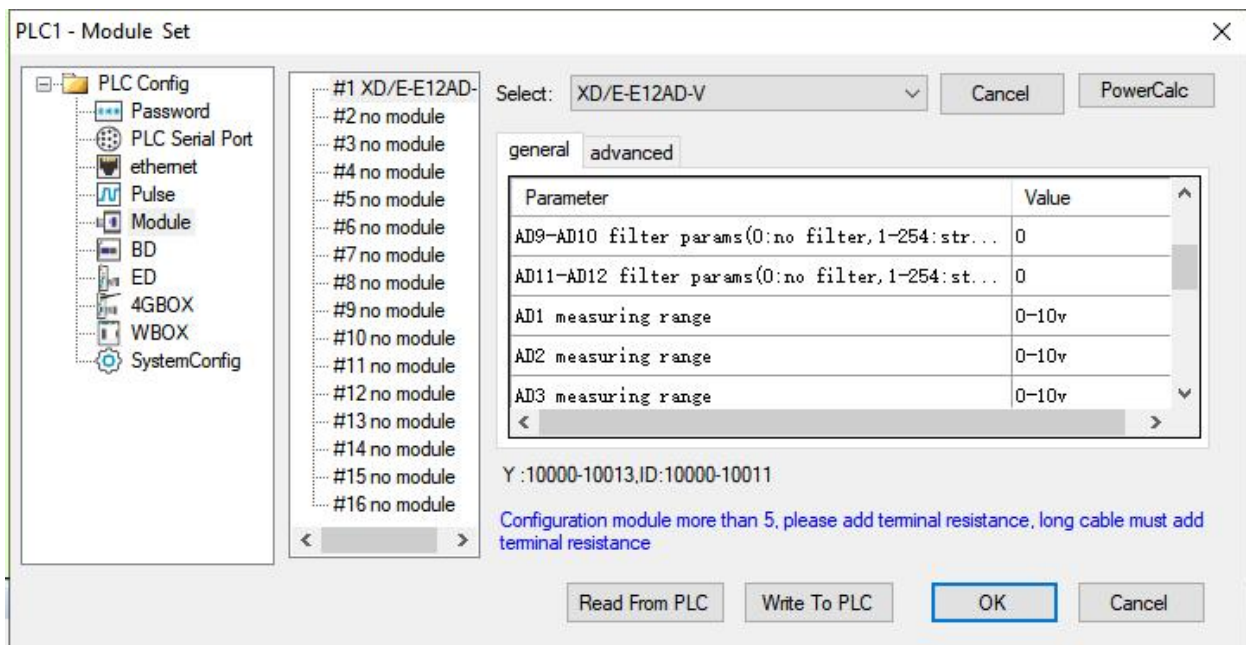

Flash registers:

The module is voltage input mode, the voltage range include 0~10V, 0~5V, -10~10V, -5~5V. Set the modes through SFD registers of PLC. See the following table:

Module no.	SFD address	Module no.	SFD address
#1	SFD350~SFD359	#9	SFD430~SFD439
#2	SFD360~SFD369	#10	SFD440~SFD449
#3	SFD370~SFD379	#11	SFD450~SFD459
#4	SFD380~SFD389	#12	SFD460~SFD469
#5	SFD390~SFD399	#13	SFD470~SFD479
#6	SFD400~SFD409	#14	SFD480~SFD489
#7	SFD410~SFD419	#15	SFD490~SFD499
#8	SFD420~SFD429	#16	SFD500~SFD509

Note: each SFD register can set 4 channels mode. Each register has 16 bits, every 4 bits set one channel mode.

SFD bit definition:

Register	Bit7	Bit6	Bit5	Bit4	Bit3	Bit2	Bit1	Bit0	Explanation		
SFD350	Byte0	AD channel 2, 1 filtering coefficient							AD filtering coefficient		
	Byte1	AD channel 4, 3 filtering coefficient									
SFD351	Byte2	AD channel 6, 5 filtering coefficient									
	Byte3	AD channel 8, 7 filtering coefficient									
SFD352	Byte4	AD channel 10, 9 filtering coefficient									
	Byte5	AD channel 12, 11 filtering coefficient									
SFD353	Byte6	Bit7	Bit6	Bit5	Bit4	Bit3	Bit2	Bit1		Bit0	Used to specify the input range of the AD module, Byte6's low 4 bits are the setting bits for AD channel 1, and the high 4 bits are
		AD2				AD1					
		0000: 0~10V				0000: 0~10V					
		0001: 0~5V				0001: 0~5V					
0010: -10~10V				0010: -10~10V							
0011: -5~5V				0011: -5~5V							

	Byte7	Bit7	Bit6	Bit5	Bit4	Bit3	Bit2	Bit1	Bit0	the setting bits for AD channel 2; The low 4 bits of Byte7 are the setting bits for AD channel 3, and the high 4 bits are the setting bits for AD channel 4; The low 4 bits of Byte8 are the setting bits for AD channel 5, and the high 4 bits are the setting bits for AD channel 6; The low 4 bits of Byte9 are the setting bits for AD channel 7, and the high 4 bits are the setting bits for AD channel 8; The low 4 bits of Byte10 are the setting bits for AD channel 9, and the high 4 bits are the setting bits for AD channel 10; The low 4 bits of Byte11 are the setting bits for AD channel 11, and the high 4 bits are the setting bits for AD channel 12
		AD4				AD3				
		0000: 0~10V				0000: 0~10V				
		0001: 0~5V				0001: 0~5V				
0010: -10~10V				0010: -10~10V						
0011: -5~5V				0011: -5~5V						
SFD354	Byte8	Bit7	Bit6	Bit5	Bit4	Bit3	Bit2	Bit1	Bit0	
		AD6				AD5				
		0000: 0~10V				0000: 0~10V				
		0001: 0~5V				0001: 0~5V				
	0010: -10~10V				0010: -10~10V					
	0011: -5~5V				0011: -5~5V					
	Byte9	Bit7	Bit6	Bit5	Bit4	Bit3	Bit2	Bit1	Bit0	
		AD8				AD7				
0000: 0~10V				0000: 0~10V						
0001: 0~5V				0001: 0~5V						
0010: -10~10V				0010: -10~10V						
0011: -5~5V				0011: -5~5V						
SFD355	Byte10	Bit7	Bit6	Bit5	Bit4	Bit3	Bit2	Bit1	Bit0	
		AD10				AD9				
		0000: 0~10V				0000: 0~10V				
		0001: 0~5V				0001: 0~5V				
	0010: -10~10V				0010: -10~10V					
	0011: -5~5V				0011: -5~5V					
	Byte11	Bit7	Bit6	Bit5	Bit4	Bit3	Bit2	Bit1	Bit0	
		AD12				AD11				
0000: 0~10V				0000: 0~10V						
0001: 0~5V				0001: 0~5V						
0010: -10~10V				0010: -10~10V						
0011: -5~5V				0011: -5~5V						
SFD356~SFD359		-								

Take the first module as an example to explain the setting method.

Example: To set the working mode of the first module's input channels 1 and 0 to 0-10V, the working mode of input channels 3 and 2 to 0-5V, the working mode of input channels 7, 6, 5, and 4 to -10-10V, the working mode of input channels 11, 10, 9, and 8 to -5-5V, the filtering coefficient of channels 0, 1, 2, 3, 4, and 5 to 254, and the filtering coefficient of channels 6, 7, 8, 9, 10 and 11 is set to 100.

Method 1:

It can be directly configured on the configuration panel, as shown in the above figure.

Method 2:

Directly set the SFD special register to the following values:

SFD350=FEFEH SFD351=64FEH SFD352=6464H SFD353=1100H SFD354=2222H
SFD355=3333H

21-5. Exterior connection

Notes:

- When connect external +24V power, please use the 24V power of PLC to avoid interference.
- To avoid interference, please use shield cable and single point ground for the shield layer.

Voltage single end input:

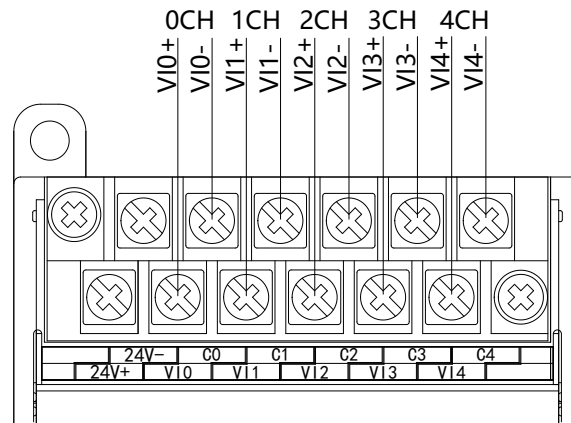

21-6. AD conversion diagram

The relationship between analog value and digital value is shown as the following diagram:

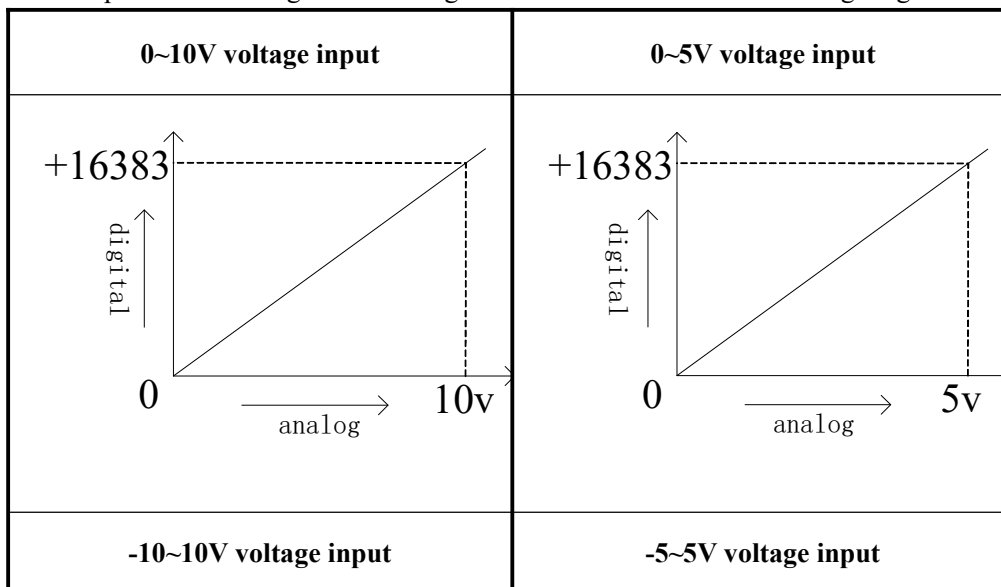

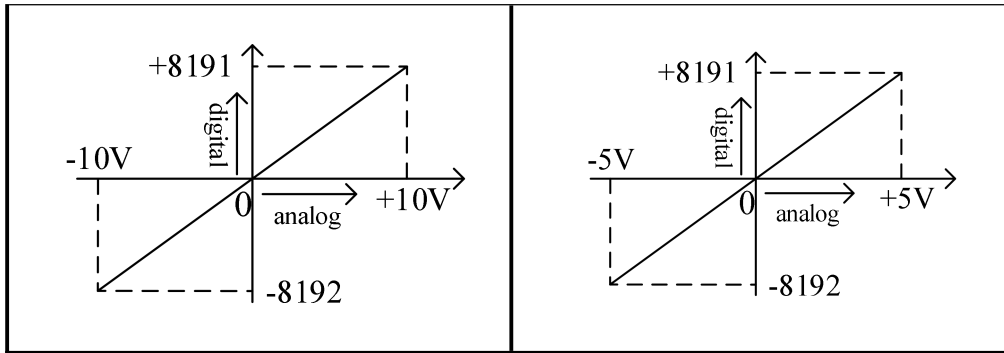

Note: When the channel enable bit is turned on and the AD voltage input is suspended, the corresponding ID register is displayed as 16383; When the AD current input is suspended, the corresponding ID register is displayed as 0. When the channel enable bit is turned off, the ID register corresponding to the AD voltage/current input is displayed as 0.

21-7. Program application

Real-time read the data of the 12 channels (module no.1)

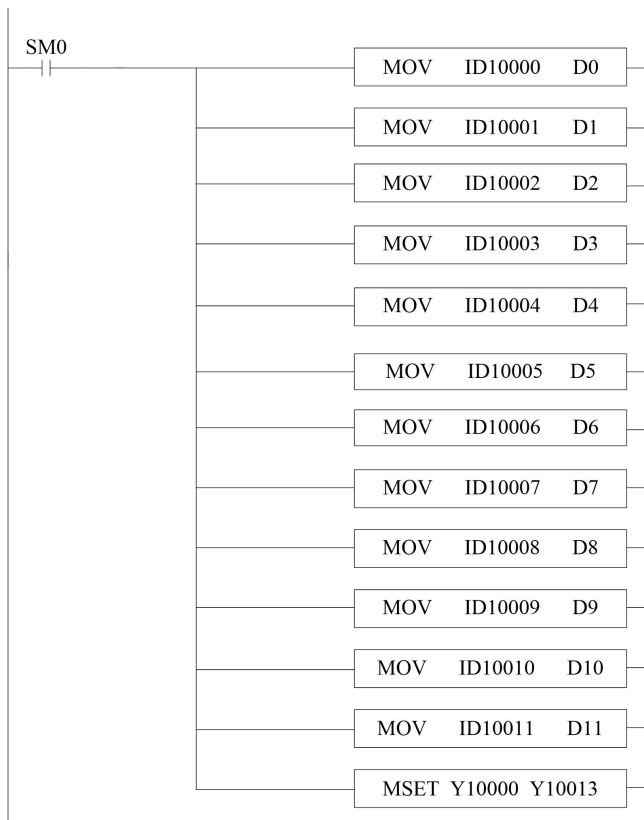

Explanation:

SM0 is always ON coil when the PLC is running. PLC keeps on writing channel 0 data to D0, channel 1 data to D1, channel 2 data to D2, channel 3 data to D3, channel 4 data to D4, channel 5 data to D5, channel 6 data to D6, channel 7 data to D7, channel 8 data to D8, channel 9 data to D9, channel 10 data to D10, channel 11 data to D11. Set ON all the channels enable bits.

XINJE

WUXI XINJE ELECTRIC CO., LTD.

No.816, Jianzhu West Road, Binhu District, Wuxi City, Jiangsu Province, China



214072

Tel: 86-0510-85134139

Fax: 86-0510-85111290

Email: Fiona.xinje@vip.163.com

www.xinje.com